



# Nutrient Criteria Technical Guidance Manual

## Lakes and Reservoirs

**First Edition**



# **Nutrient Criteria Technical Guidance Manual**

## **Lakes and Reservoirs**

**Written by**

**George Gibson, U.S. Environmental Protection Agency**

**Robert Carlson, Kent State University**

**Jonathan Simpson, Tetra Tech, Inc.**

**Eric Smeltzer, Vermont Department of Environmental Conservation**

**Jeroen Gerritson, Tetra Tech Inc.**

**Steven Chapra, University of Colorado**

**Steven Heiskary, Minnesota Pollution Control Agency**

**Jack Jones, University of Missouri**

**Robert Kennedy, U.S. Army Corps of Engineers**

# Acknowledgments

The authors wish to thank the following peer reviewers for their assistance in the preparation of this manuscript: Roger Bachman, University of Florida; Nina Caraco, Institute of Ecosystem Studies; Douglas Knaur, Wisconsin Department of Natural Resources; Matthew Liebman, USEPA Region I; James Peterson, University of Wisconsin; and Val Smith, University of Kansas. Their detailed and insightful comments and criticisms are appreciated.

Additional internal reviews, especially with respect to EPA methods, policy, and regulations were provided by specialists from the Office of General Counsel, Office of Science and Technology - Standards and Applied Science Division; Office of Wetlands, Oceans and Watersheds; Office of Wastewater Management; and EPA Regional Nutrient Coordinators. State agencies and private interest groups also offered comments. All timely opinions were considered and addressed where possible in this edition. In this respect, Joanna Taylor, The CDM Group, Inc., patiently and graciously made repeated format changes to this manuscript as it was being completed.

As with any prototype technical guidance, differences about methods and approaches are to be expected. This and subsequent guidance manuals for other water body types are not intended to be singular, one-time publications. As experience accumulates, future editions will be prepared. Suggestions not presently incorporated may be revisited and appear in later versions.

## Disclaimer

This manual provides technical guidance to States, Indian Tribes, and other authorized jurisdictions to establish water quality criteria and standards under the Clean Water Act (CWA), to protect aquatic life from acute and chronic effects of nutrient overenrichment. Under the CWA, States and Indian Tribes are to establish water quality criteria to protect designated uses. State and Indian tribal decisionmakers retain the discretion to adopt approaches on a case-by-case basis that differ from this guidance when appropriate and scientifically defensible. While this manual constitutes EPA's scientific recommendations regarding ambient concentrations of nutrients that protect resource quality and aquatic life, it does not substitute for the CWA or EPA's regulations; nor is it a regulation itself. Thus, it cannot impose legally binding requirements on EPA, States, Indian Tribes, or the regulated community, and might not apply to a particular situation or circumstance. EPA may change this guidance in the future.

# Contents

<b>Executive Summary</b> .....	viii
<b>Chapter 1. Introduction</b> .....	1-1
A. Purpose of This Document .....	1-1
B. Relationship Between Water Quality Standards and Criteria .....	1-2
C. Uses of Nutrient Criteria .....	1-3
1. Identification of Problems .....	1-3
2. Management Planning .....	1-3
3. Regulatory Assessments .....	1-3
4. Project Evaluations .....	1-4
5. Status and Trends of Water Resources .....	1-4
D. Overview of the Nutrient Criteria Development Process .....	1-4
1. Strategy for Reducing Cultural Eutrophication .....	1-6
2. Nutrient Criteria Development Process .....	1-7
<b>Chapter 2. The Basis for Lake and Reservoir Nutrient Criteria</b> .....	2-1
A. Historical Perspective .....	2-1
B. The Nutrient Paradigm .....	2-2
1. Phosphorus and Nitrogen as Limiting Factors for Algal Biomass .....	2-3
2. Role of the Watershed .....	2-4
3. Trophic Causal Chain .....	2-5
4. Lake Aging .....	2-6
C. Connecting Watershed Loading to the Lake: A Mass Balance Model Approach .....	2-8
D. Trophic State Classification Systems .....	2-11
E. Uses of Trophic State Indices .....	2-16
<b>Chapter 3. Preliminary Steps for Criteria Development</b> .....	3-1
A. Defining the Resource of Concern .....	3-1
B. Classification .....	3-2
1. Geographic Divisions .....	3-2
2. Nongeographic Classifications .....	3-3
3. Covariates .....	3-10
<b>Chapter 4. Establishing an Appropriate Database</b> .....	4-1
A. Introduction .....	4-1
B. Evaluating Existing Data .....	4-1
1. Potential Data Sources .....	4-2
2. Quality of Historical Data .....	4-4
3. Data Reduction .....	4-5
C. New Data Collection .....	4-6
1. Types of Monitoring Associated With Nutrient Criteria .....	4-6
2. Sampling Design .....	4-8
D. Database Management .....	4-13
1. Modernized STORET .....	4-13
2. EDAS .....	4-14

<b>Chapter 5. Candidate Variables for Criteria Setting</b> .....	5-1
A. Introduction .....	5-1
B. Nutrient Variables .....	5-1
1. Phosphorus .....	5-1
2. Nitrogen .....	5-3
C. Biological Variables .....	5-4
1. Organic Carbon .....	5-4
2. Chlorophyll a .....	5-5
3. Secchi Disk Transparency .....	5-7
4. Dissolved Oxygen .....	5-8
5. Macrophytes .....	5-9
6. Biological Community Structure .....	5-10
D. Land Use .....	5-12
<b>Chapter 6. Identifying and Characterizing Reference Conditions</b> .....	6-1
A. Significance of Reference Conditions .....	6-1
B. Approaches to Establishing Reference Conditions .....	6-1
1. Direct Observation of Reference Lakes .....	6-2
2. Paleolimnological Reconstruction .....	6-4
3. Model Prediction and Extrapolation .....	6-6
C. Initial Data Retrieval and Processing to Support Ecoregional Nutrient Criteria Development .....	6-7
<b>Chapter 7. Nutrient Criteria Development</b> .....	7-1
A. Elements of Nutrient Criteria .....	7-1
1. Investigation of the Historical Record .....	7-1
2. Establishment of the Reference Condition .....	7-2
3. Use of Models .....	7-2
4. Expert Assessment of Information .....	7-2
5. Attention to Downstream Effects .....	7-2
B. Development of Ecoregional Nutrient Criteria .....	7-3
1. Regional and Lake/Reservoir Type Classification .....	7-3
2. Conversion of Ecoregional Data to a Reference Condition and Preliminary Nutrient Criteria .....	7-3
3. Refine Ecoregion Reference Condition Values .....	7-5
4. Evaluation by Regional Teams .....	7-5
5. Examples of the Deliberation Associated with Development of a Nutrient Criterion .....	7-7
C. Development of State Nutrient Criteria .....	7-8
1. Designated Use .....	7-8
2. Hypothetical Illustration of the Relationship of State Criteria to Protect Designated Uses Compared With an Ecoregional Criterion for TP .....	7-12
3. Frequency Distribution Approach .....	7-14
D. Developing Nutrient Criteria Implementation Procedures .....	7-14
1. Decisionmaking .....	7-16
2. Multivariable Enrichment Index .....	7-16
E. Frequency and Duration .....	7-17

<b>Chapter 8. Using Nutrient Criteria To Protect Water Quality</b> .....	8-1
A. State Water Quality Standards .....	8-1
1. Water Quality Standards and the Clean Water Act .....	8-1
2. Protecting Designated Uses .....	8-2
3. Maintaining Existing Water Quality .....	8-2
4. Providing Flexibility in Implementation .....	8-3
B. Water Quality–Based Approach to Pollution Control .....	8-4
Step 1: Identification of Impaired and Threatened Waters .....	8-5
Step 2: Priority Ranking and Targeting .....	8-6
Step 3: Development of TMDLs .....	8-6
Step 4: Implementation of Controls .....	8-7
Step 5: Assessment of Controls .....	8-8
C. Nonpoint Source Pollution Management .....	8-9
1. Guidance for Controlling Nonpoint Sources of Nutrients .....	8-10
2. Nonpoint Source Management Programs .....	8-11
3. Coastal Nonpoint Pollution Control Programs .....	8-12
4. Farm Bill Conservation Provisions .....	8-13
D. A Comprehensive Procedure for Nutrient Management .....	8-15
1. Status Identification .....	8-15
2. Background Investigation .....	8-15
3. Data Gathering and Diagnostic Monitoring .....	8-17
4. Source Identification .....	8-19
5. Management Practices for Nutrient Control .....	8-19
6. Detailed Management Plan .....	8-21
7. Implementation and Communication .....	8-21
8. Evaluation Monitoring and Periodic Review .....	8-22
9. Completion and Evaluation .....	8-22
10. Continued Monitoring of the System .....	8-22
E. Resources .....	8-23
<b>Chapter 9. Modeling Tools</b> .....	9-1
A. Introduction .....	9-1
B. Review of Lake/Reservoir Eutrophication Modeling Frameworks .....	9-1
1. Empirical Models .....	9-1
2. Nutrient Budget/Mass Balance Models .....	9-3
3. Nutrient/Food Chain Models .....	9-5
C. Model Use for Aiding in the Establishment of Reference Conditions .....	9-7
1. Morphoedaphic Index .....	9-7
2. Mass Balance Models with Loading Estimation .....	9-7
D. Watershed Management Models .....	9-14
1. Mid-Range Watershed-Scale Loading Models .....	9-14
2. Detailed Watershed Loading Models .....	9-17
<b>References</b> .....	<b>R-1</b>
<b>Appendix A. Nutrient Region Descriptions</b> .....	<b>A-1</b>
<b>Appendix B. Case Studies</b> .....	<b>B-1</b>

# Executive Summary

Overenrichment of surface waters in the United States has been a long-standing problem to the extent that approximately half of the waters reported by the States to be impaired are attributed to excess nutrients and related biological growth. The EPA has established the National Nutrient Criteria Program to address this water quality problem. The surface waters of concern are lakes and reservoirs, streams and rivers, estuaries and coastal marine waters, and wetlands. Criteria representing enrichment conditions of surface waters that are minimally impacted by human developmental activities will be developed for each of the regions of the country. These will then become the basis for States and Tribes of the United States to develop nutrient criteria to protect the designated uses of those waters. This manual is designed to help accomplish this for lakes and reservoirs.

Nitrogen and phosphorus are the primary causes of overenrichment and are obvious nutrient criteria variables, but biological response variables are also important in addressing the consequences of overenrichment.

Limnologists and lake managers have developed a general consensus about freshwater lake responses to nutrient additions, that essentially an ambient total phosphorus (TP) concentration of greater than about 0.01 mg/L and or a total nitrogen (TN) of about 0.15 mg/L is likely to predict blue-green algal bloom problems during the growing season. Similarly, chronic overenrichment leads to lake quality degradation manifested in low dissolved oxygen, fish kills, algal blooms, expanded macrophytes, likely increased sediment accumulation rates, and species shifts of both flora and fauna.

However, because some parts of the country have naturally higher soil and parent material enrichment and different precipitation regimes, the application of that general consensus approach has to be adjusted by region. Therefore, an ecoregional and reference condition approach is necessary to develop nutrient criteria appropriate to each of the different geographical and climatological areas of the country. Initially, the continental United States has been divided into 14 separate ecoregions of similar geographical characteristics, and criteria will be developed for each.

While additional variables may be used as nutrient criteria, the initial effort will concentrate on TP, TN, algal chlorophyll, and Secchi depth or similar measure of algal turbidity to reflect the primary production response to overenrichment. Thus, the criteria involve four basic indicators of overenrichment. Other indicators, such as dissolved oxygen (DO) and macrophyte growth or speciation, and other flora and fauna changes are also deemed useful, but the first four are paramount, especially the two limiting nutrients. Throughout the country, cultural eutrophication (or overenrichment) is largely caused by either too much N or P or some combination of the two in their various forms. Nitrogen may not be critical to many fresh water lakes, but it does become significant in estuaries and coastal waters downstream. An essential part of the process for developing nutrient criteria is to pay attention to downstream effects. Therefore, nitrogen as well as phosphorus reduction for lakes is needed to benefit the lower reaches of the overall system.

TN and TP are described as causal variables, and chlorophyll and algal turbidity are initial response variables. Measuring just the response variables clearly shows the existence of a problem, but waters with a short retention time could look clear and be aesthetically acceptable, and could still be sending an unacceptable load of N and P downstream to be someone else's problem. This is why EPA expects downstream effects to be considered as part of the nutrient criteria development process.



Nutrient criteria development consists of five elements:

1. Historical data and other information to provide an overall perspective on the status of the resource.
2. Present reference sites and their collective reference condition describing the current status.
3. Modeling to refine data implications and analysis above if necessary.
4. Objective assessment of all of the above information by the States and by the EPA Regional Technical Assistance Groups (RTAGs), a board of State and Federal specialists established in each EPA Region to help develop and administer the National Nutrient Criteria Program, to establish the ecoregional criteria, and to review proposed State or Tribal nutrient criteria.
5. Attention to downstream consequences before the criterion is finally established.

Using this approach, EPA ecoregional benchmark criteria can be established that States and Tribes can use to help set their own criteria to protect all their designated uses. A key responsibility of the RTAGs, with their best knowledge of regional water quality and management potential, is the development of these ecoregional criteria and review of subsequent State and Tribal criteria. A summary of the procedural approach for ecoregional criteria development is as follows:

The RTAGs collect as much existing reference quality data for at least the four principal variables as possible from STORET, States and Tribes, universities, local governments, and other Federal agencies. Data collection is directed to the particular waterbody type of interest and to established physical classes of those waters, e.g., small, medium, and large volume lakes. Because the States are all represented on the RTAG, they are fully involved in the process.

- The data are reviewed for quality and utility and then the distribution of data points throughout the ecoregion for each class is assessed and additional data gathered if needed.
- When satisfied with the adequacy of the data distribution for the classes, the reference sites within each ecoregion are compared. If there are obvious shifts in reference values (e.g. through cluster analysis) the ecoregion is subdivided accordingly or perhaps boundaries are shifted. The same assessment should be made for temporal distribution to determine if seasonal criteria are needed. Both of these divisions should help reduce variability in the reference condition as well, albeit with the risk of reducing the population of applicable observations.
- In the process, the RTAGs are expected to coordinate with their adjacent counterparts to promote consistent subregional boundaries and criteria. The EPA Headquarters nutrient criteria group will play a mediating and coordinating role in this process, but the initial determinations will be made by the RTAGs.
- The established reference conditions will then be incorporated with the other elements of criteria development—historical perspective, possible modeling of data, and concern to protect downstream waters—by the RTAG to set that particular ecoregional criterion for TP, TN, chlorophyll *a*, and Secchi depth or similar measure of organic based turbidity.

These ecoregional criteria would typically serve as the basis for proposing and promulgating a water quality standard when a State or Tribe fails to adopt an acceptable standard. EPA expects the States and Tribes of the Continental United States to develop nutrient criteria for each class of surface water bodies within three years of the establishment of the ecoregional criteria for those waters. It should be noted that States and Tribes may elect to establish their criteria using methods other than those described in these EPA guidance manuals. EPA promotes such flexibility so long as the proposed alternative is:

- Based on a scientifically defensible approach
- Contains sufficient parameters to address nutrient overenrichment causes and responses, i.e., consistent with the variables designated by EPA and with the five nutrient criteria elements listed above
- Protects and maintains downstream water quality sufficient to preserve the beneficial uses of those waters. In addition to criteria to protect the uses, States must adopt antidegradation policies and procedures to protect and maintain existing water quality.

Hawaii, Alaska, and U.S. Trust Territories will develop separate ecoregions in conjunction with their RTAGs and the National Nutrient Criteria Program.

This manual concludes with chapters describing data models, and management options available to the States and Tribes to actively protect or restore their lake resources. Case histories illustrating nutrient criteria development and management efforts are also appended with the names of individual specialists to contact for more information.

#### *Editorial Note*

Throughout this text, reference is made to the roles and responsibilities of “States” or “States and Tribes.” This term or phrase is intended to mean those jurisdictions with the appropriate responsibility and authority and may also include the District of Columbia, Territories, or other governmental entities.

# CHAPTER 1

## Introduction

- A. Purpose of This Document
- B. Relationship Between Water Quality Standards and Criteria
- C. Uses of Nutrient Criteria
- D. Overview of the Nutrient Criteria

### A. Purpose of This Document

Nutrient overenrichment is a major source of water pollution in the United States. The link between eutrophication—the overenrichment of surface waters with plant nutrients—and public health risks has long been presumed but not definitively documented (Bachman, personal communication, 1999). However, corollaries with bacterial indicators such as (1) *Escherichia coli* and the spread of disease in sewage-enriched waters, (2) trihalomethanes in chlorine-treated eutrophic reservoirs, and (3) recent concerns over the incidence of *Pfiesteria piscicida* in eutrophic estuarine surface waters with suspected attendant human illnesses, all suggest that overenrichment pollution is not only an aesthetic, aquatic community problem, but a public health problem as well. A major element of the U.S. Environmental Protection Agency's (EPA's) National Nutrient Strategy for the Development of Regional Nutrient Criteria (U.S. EPA, 1998), also referred to as the National Nutrient Strategy, is the development of water-body-type-specific technical guidance documents that can be used to assess potential nutrient-related trophic state impairment and to develop region-specific nutrient criteria to help address this pollution problem. This document provides this guidance for lakes and reservoirs. A similar document is being prepared for rivers and streams, and future documents will be prepared for estuarine and coastal marine areas and for wetlands.

Because of diverse geographic and climate conditions, single national nutrient criteria for lakes and reservoirs are not appropriate. Instead, nutrient criteria must be developed at the State, regional, or individual water body levels. This document, therefore, does not attempt to set national criteria, but provides State and tribal water quality managers with guidance on how they can set criteria themselves. The document provides background information on classifying water bodies and selecting variables that can potentially be used as criteria, and it describes methods for developing appropriate values for these criteria. The document also provides information on sampling, data processing, and appropriate management techniques.

Because nutrient overenrichment consistently ranks as one of the top causes of water resource impairment, this initiative is designed to address that particular water quality problem. It is important to recognize what is meant by nutrient overenrichment. In the context of this guidance manual, overenrichment means the addition of nutrients causing adverse effects or impairment to designated use(s) of the water body or to the ecosystem. Symptoms of such impairment include but are not limited to frequent nuisance algal blooms, fish kills, overabundance or decline of macrophytes, and loss of top predators from the food chain.

It is also important to recognize that the best way to manage for nutrient control is to reduce the human-caused fraction of the nitrogen, phosphorus, or related nutrients entering the waters. This often is referred to as cultural eutrophication to distinguish this enrichment from the inherent nutrient load entering the water body from soils and parent material indigenous to the area in the absence of disruptive

erosion. Cultural eutrophication results from such human endeavors as construction activities, sewage discharges, agricultural practices, and residential development. This guidance manual is intended to help the user develop criteria useful for abating cultural eutrophication.

## **B. Relationship Between Water Quality Standards and Criteria**

States and authorized Tribes are responsible for developing water quality standards to protect the physical, biological, and chemical integrity of their waters. A water quality standard defines the quality goals for a water body by designating specific uses of a water body, setting criteria to protect those uses, and establishing an antidegradation policy to protect existing water quality. The uses of a water body include “existing uses” that were attained on or after November 28, 1975 (the date of the promulgation by EPA of the first water quality standards regulations) and “designated uses,” which are desired uses that may or may not already be attained. At a minimum, a water body’s uses must include recreation in and on the water and propagation of fish and wildlife unless the State performs, and EPA approves, a use attainability analysis justifying a different designated use. Other specific use categories such as boating, trout propagation, or potable water supply also may be adopted.<sup>1</sup>

After designating the uses of a water body, the State must adopt numeric and/or narrative criteria to protect and support the specified uses (33 USC § 1313 (c) (2)). Such criteria must be based on a sound scientific rationale and must contain sufficient parameters to protect the designated use(s). Narrative criteria describe the desired water quality conditions in a qualitative context. They are the basis for water quality assessments. An example is shown below:

*All waters shall meet generally accepted aesthetic qualifications, shall be capable of supporting desirable aquatic life, and shall be free from substances, conditions, or combinations thereof attributable to human activities that produce objectionable color, odor, or taste or induce the growth of undesirable aquatic life.*

Numeric criteria, on the other hand, are quantitative values assigned to measurable components in the water body. An example of a numeric criterion might be that a lake’s average total phosphorus concentration should “not exceed 20 µg/L during the summer growing season.” Narrative and numeric criteria should work in combination to:

- Form the basis for consistent measurement of environmental quality
- Provide distinct interpretations of acceptable and unacceptable conditions that can be debated by concerned parties
- Reduce ambiguity for management and enforcement decisions

This document deals specifically with the establishment of nutrient criteria for lakes and reservoirs (under the authority of the Clean Water Act Section 304) as a means of addressing nutrient overenrichment problems. However, for these types of criteria to be effective, they should be accompanied by responsive nutrient management approaches.

---

<sup>1</sup>The EPA water quality standards regulations are at 40 CFR Part V31, and guidance on their implementation is in the EPA water quality standards handbook (EPA-823-B-94-00Sa).

A responsible nutrient management plan should meet three practical conditions. First, the plan and its component elements must be scientifically defensible, otherwise it might lead to well-intentioned management actions that are unnecessary or harmful. This is like the admonition to physicians “above all do no harm.” Second, effective nutrient management must strive to be economically feasible. The public and local affected interests are likely to support approaches that are economically feasible and that provide meaningful benefit compared with their cost. Finally, these approaches should be practical and acceptable to the communities involved. The approaches should address appropriate social and political issues, such as conflicts that might exist between public agencies and landowners or between watershed residents and lake users. Any management plan may fail if these three general elements are not sufficiently addressed, and it is almost certain to fail if they are all ignored.

## **C. Uses of Nutrient Criteria**

### ***1. Identification of Problems***

EPA expects that the process of collecting current data and surveying more lakes and reservoirs than have been investigated previously will produce new information revealing conditions not heretofore recognized. By comparing the water quality criteria for nutrients to actual water quality, the resource management decisionmakers may well recognize overenriched lakes or reservoirs or portions of these water bodies for the first time. These new problems can be incorporated into the information system so that remediation can be initiated.

### ***2. Management Planning***

The nutrient criteria development process not only establishes these benchmarks identifying overenrichment, but it also makes it possible to rank the relative magnitude of the problems with respect to each other. A scale of overenrichment with a frequency distribution can be created to readily identify the scope of the enrichment problems to be addressed and the numbers of lakes or impoundments in each state of degradation. Modeling plays a significant role here either to supplement existing data sets or to assess the projected effect of various options and combinations of management approaches.

Thus, a form of triage can be practiced to assign scarce manpower and funds in an efficient way. For example, a State may create a balance by (1) protecting many high-quality lakes, (2) restoring several moderately degraded lakes by implementing cost-effective land use changes early on, and (3) designating for restoration one or a few badly overenriched systems, realizing that only a long-term, protracted project and budget will suffice.

### ***3. Regulatory Assessments***

Much of the management work done by EPA and the States is regulatory, and the nutrient criteria, once established, should be incorporated into State standards to become the basis of enforceable tools. These values are used to develop limits in National Pollutant Discharge Elimination System (NPDES) permits for point source discharges. The permit limits for nitrogen, phosphorus, and other trace nutrients emitted from waste water treatment plants, factories, food processors, and other dischargers can be appropriately adjusted and enforced in accordance with the criteria.

Similarly, total maximum daily load (TMDL) estimates used to allocate remediation responsibilities, especially regarding nonpoint sources on a watershed basis, can be established with respect to these nutrient criteria. Knowing the optimum nutrient load for a lake (and its downstream recipient waters)

makes it possible to divide and allocate that load among the tributary subwatersheds of the system. Resource managers then can begin land use improvements and other activities necessary to improve the system in a methodical way and on a reasonable scale so that restoration can be achieved.

The criteria portion of water quality standards also may be used in antidegradation reviews and can serve in the development of best management practices for State and local nonpoint source programs.

#### **4. Project Evaluations**

Nutrient criteria can be applied further to evaluate the relative success of management activities such as those described immediately above. Although it may sometimes be expensive and frustrating, “before, during, and after” measurements of nutrient enrichment variables in the receiving waters, when compared with the criteria, provide an objective and direct assessment of the success of the management project.

#### **5. Status and Trends of Water Resources**

Throughout the continuing process of problem identification, response and remediation, and evaluation to protect and enhance our water resources, the States and EPA are required by section 305(b) of the Clean Water Act to periodically report to Congress on the status of the Nation’s waters. The nutrient criteria would expand and refine that report by adding an additional set of both causal and response parameters to the measurement process. The States and EPA will be able to compare the measured enrichment conditions of their lakes and reservoirs and document the changes that have resulted and the relative progress made.

The rest of this guidance manual presents detailed information that elaborates on this important material. The intent is to present essentially a two-part guidance document, the first half of which is a presentation of the science and technology associated with the measurements required and processes associated with the development of the benchmark nutrient criteria needed to make enrichment identifications. The second part addresses the equally important process of making management decisions to protect and enhance the trophic state of our Nation’s waters and to evaluate the relative success of that management so we can know what works and what does not, so that the next round of criteria development and management will be conducted from a truly expanded base of knowledge.

### **D. Overview of the Nutrient Criteria Development Process**

A distribution of lakes may exhibit a range of nutrient conditions. Using total phosphorus as an example, some lakes may have little or no enrichment and consequently a limited number of species and individuals or biomass. Lake Superior is a classic example of such conditions of oligotrophy. At the other extreme of phosphorus enrichment is massive overenrichment with so much phosphorus in the water column that algal blooms or choking macrophyte growth and frequent fish kills are common. Species diversity in these hypereutrophic lakes is also low even though biomass is usually very high. These are the “pea soup” lakes most communities associate with badly degraded conditions.

Phosphorus concentrations typical for both extremes can be measured, but an in-lake total phosphorus concentration of less than 10 µg/L generally is considered to be oligotrophic. Conversely, 100 µg/L often is used as the threshold for hypereutrophication (Vollenweider, 1968; Wetzel, 1975; Carlson, R., personal communication, 1999). Although such levels are known to exist naturally, more often concentrations of this magnitude are associated with extensive or intensive cultural development.

Natural enrichment ranges throughout these magnitudes of concentration according to geographic and geological regions of the country. Consequently, it would be necessary to determine the natural ambient background for each lake so that the eutrophication caused by human development and abuse can be addressed. Addressing this cultural eutrophication is the objective of this manual, but the development of nutrient criteria on a lake-by-lake basis may be prohibitively time consuming and expensive for States and Tribes.

Alternatively, these lakes or reservoirs can be divided into regionally similar groups based on their physical characteristics within a proximal geographic area. Those lakes of each established group having the least land development or other human impact can be identified as the reference lakes for measuring relatively undisturbed nutrient conditions appropriate for that class and region. This reference condition information, within an appropriate historical context and objectively interpreted, then can become a candidate criterion for use as a benchmark against which other similar lakes may be compared. Before the criterion is finally established, however, the scientists and resource managers involved should assure themselves that it also will have a beneficial or at least neutral downstream effect on the lakes, reservoirs, streams, or estuaries within or just below the area of application. This concept, as illustrated in Figure 1.1, is essentially the basis for the National Nutrient Criteria Program and is described variously throughout this text.

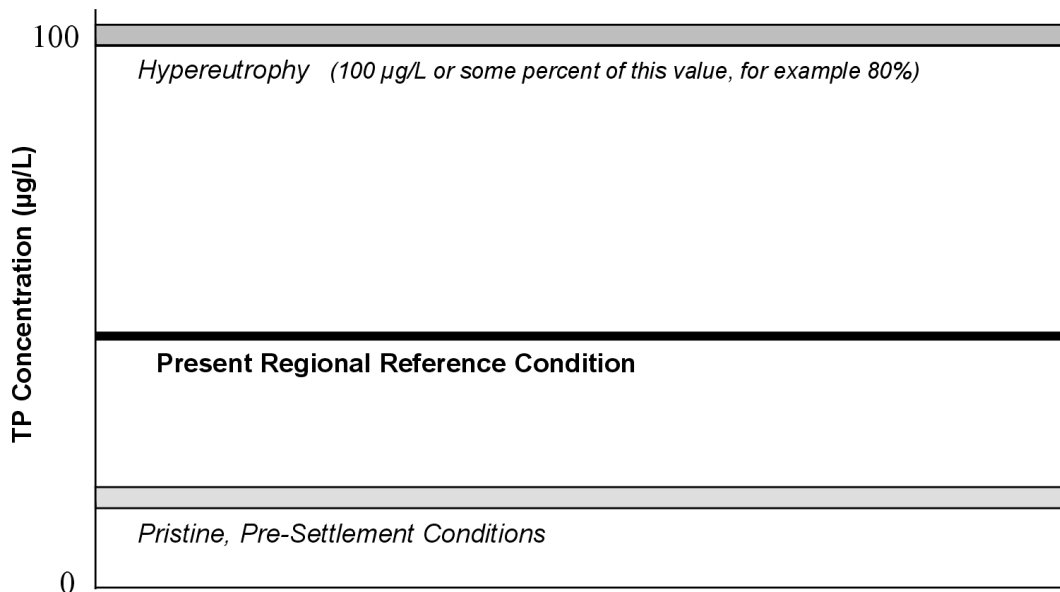

**Figure 1.1. Conceptual basis for the National Nutrient Criteria Program using TP as an example variable.**

The two extreme values of hypereutrophy and pristine or presettlement conditions can be estimated from monitoring, historical records, and paleolimnological determinations. The reference condition, located within this measured range, and the derived criteria are scientifically based. But they also include a conscious decision to use areas of least human impact as indicators of low cultural eutrophication. A measure of best practical judgment is also necessary where scientific methods and data are not adequate for the decisions necessary for water resource protection.

The use of minimally impacted reference sites has been adapted from biological criteria development and is endorsed by EPA's Science Advisory Board (1992). Conditions that represent minimal impacts provide a baseline that should protect the inherent beneficial uses of the Nation's waters. The use of scientific rationale together with practical resource management is called for in the selection of a percentile distribution of values as a reference condition. The term "minimally impacted" implies a high-end percentile of conditions in reference lakes and a low-end percentile of the conditions in all lakes (i.e., some enrichment is allowed, but not enough to cause adverse in-lake effects or adverse downstream effects). The upper end of the range of data from purposely identified reference sites represents the bare minimum threshold of a reference condition, whereas lower percentiles of the reference site data represent high-quality conditions that may not need to be achieved or cannot be achieved in the entire population of lakes in an ecoregion. The upper 25th percentile represents an appropriate margin of safety to add to the minimum threshold, excludes the effect of spurious outliers, and serves as a first-order recommendation of a sufficiently protective value. Data analyses performed to date indicate that the lower 25th percentile of data from a sample representative of the entire population of lakes in an ecoregion roughly approximates the upper 25th percentile of the reference data (see Chapter 6, section C, Minnesota case study). Where sufficient data are available, comparison and statistical analysis of causal and response variables can help determine effect thresholds and further refine reference conditions. Establishing the reference condition is but one element of the criteria development process. Reference condition values are appropriately modified based on examination of the historical record, modeling, expert judgment, and consideration of downstream effects.

### ***1. Strategy for Reducing Cultural Eutrophication***

Six key elements are associated with the strategy for reducing cultural eutrophication (U.S. EPA, 1998):

- EPA believes that nutrient criteria need to be established on a regional basis and need to be appropriate to each water body type. They should not be established as a single set of national numbers or values because there is simply too much natural variation from one part of the country to another. Similarly, the expression of nutrient enrichment and its measurement by necessity varies from one water body type to another. Streams do not respond to phosphorus and nitrogen the same way as lakes or coastal waters.
- Consequently, EPA has prepared guidance for these criteria on a water -body-type- and region-specific basis. With detailed manuals available for data gathering, criteria development, and management response, the goal is for States and Tribes to be able to conduct surveys and develop criteria to help them deal with the problem of nutrient overenrichment of their waters.
- To help achieve this goal, the Agency has initiated a system of EPA Regional technical and financial support operations each led by a Regional Nutrient Coordinator—a specialist responsible for providing the help and guidance necessary for States or Tribes in his or her region to accomplish the necessary environmental investigations and remediations. These



regional coordinators are guided and assisted in their duties by a team of inter-Agency and intra-Agency specialists from EPA Headquarters. This team is responsible for providing both technical and financial support to the Regional Technical Assistance Groups (RTAGs) created by these coordinators so the job can be completed and communication established and maintained between the policymaking function in Headquarters and the actual environmental management in the Regions.

- EPA will develop basic ecoregional nutrient criteria values for water body types. The regional teams and States/Tribes can use these values as guidance for developing criteria protective of designated uses; the Agency also may use these values if it elects to promulgate criteria for a State or Tribe. These criteria will have value in two contexts: (1) as the basis of water quality standards, NPDES permit limits, and as TMDL target values and (2) as decisionmaking benchmarks for management planning and assessment.
- EPA plans to provide sufficient information for States and Tribes to begin adopting nutrient standards by 2003.
- States/Tribes are expected to monitor and evaluate the effectiveness of nutrient management programs implemented on the basis of the nutrient criteria. EPA intends the criteria guidance to reflect the “natural,” minimally impaired trophic condition of a given regional class of water body. Once water quality standards are established for nutrients based on these criteria, the relative success or failure of any management effort, either protection or remediation, can be evaluated.

Thus, the six elements of the National Nutrient Criteria Program describe a process that encompasses taking measurements of the collective water resources of an area; establishing nutrient criteria that can be used for evaluating the discrete waters within that region or area; assessing individual water bodies against these criteria and associated standards; designing and conducting the appropriate management; and, finally, evaluating its relative success.

## ***2. Nutrient Criteria Development Process***

Provided below is a discussion of the activities that generally comprise the nutrient criteria development process. They are listed in the order generally followed and the subsequent chapters of this document follow this sequence. Figure 1.2 presents a schematic illustration of the criteria development process with parallel, appropriate chapter headings.

### **■ Preliminary Steps for Criteria Development (Chapter 3)**

#### *Establishment of Regional Technical Assistance Groups*

The Regional Nutrient Coordinator in each EPA Region will contact and obtain the involvement of key specialist (e.g., limnologists, water resource managers, oceanographers, stream and wetland ecologists, water chemists, and land use specialist) in that Region with respect to the water bodies of concern, and these experts should be recruited from other Federal agencies, State agencies, universities

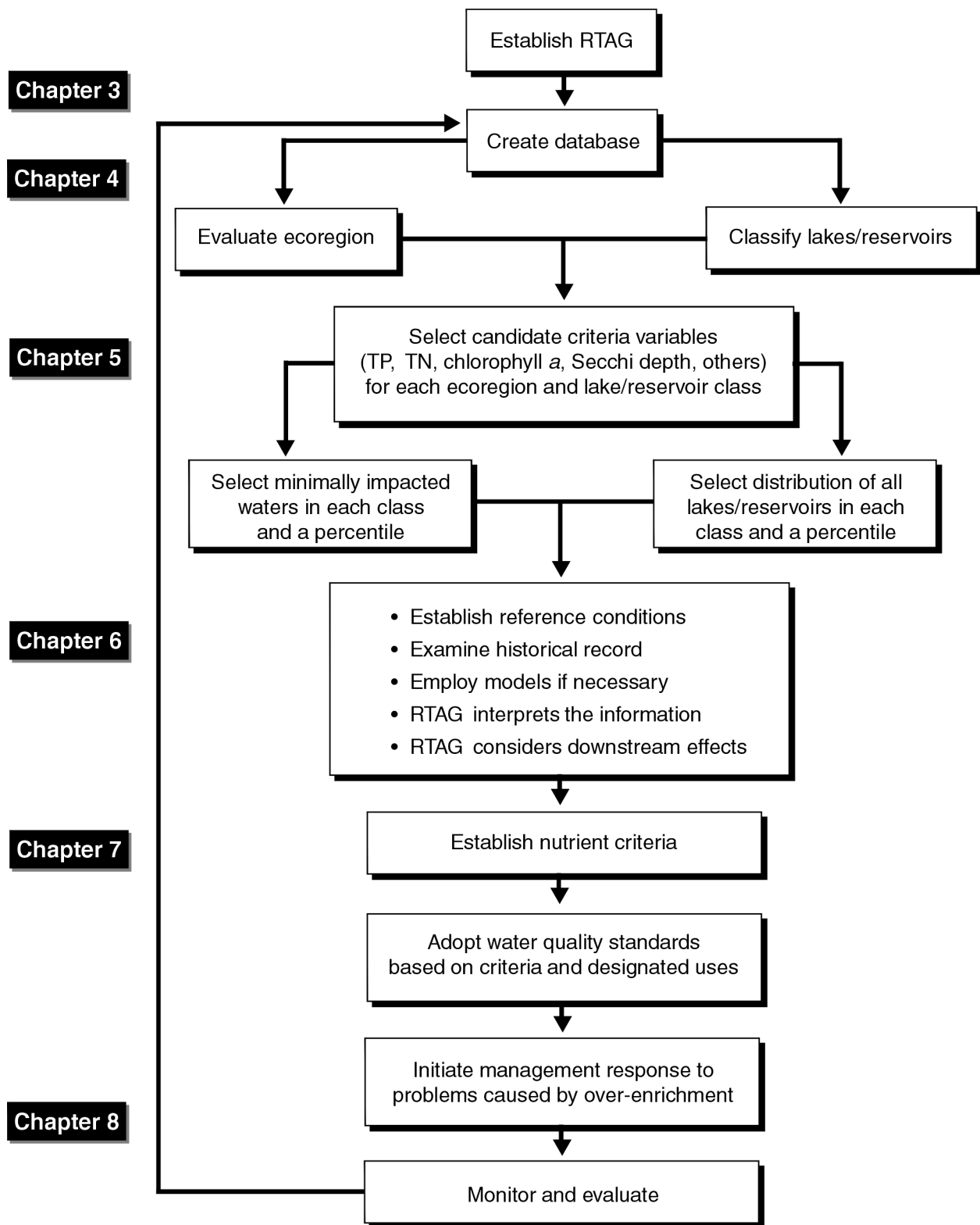

Figure 1.2. Flowchart of the nutrient criteria development process.

and colleges. Particular Federal agencies of interest are the U.S. Geological Survey (USGS), Natural Resources Conservation Service (NRCS), National Oceanic and Atmospheric Administration (NOAA), U.S. Forest Service (USFS), and the U.S. Fish and Wildlife Service (USFWS). In certain areas of the country, the U.S. Army Corps of Engineers (USACOE) or the Bureau of Land Management (BLM) or special government agencies such as the Tennessee Valley Authority (TVA) may be pertinent. Similarly, for information and education activities, especially with respect to agriculture, the USDA Cooperative Extension Service is a valuable resource. State agencies with responsibilities relevant to this effort are variously named, but are commonly referred to as: Department of Natural Resources, Department of Water Resources, Department of the Environment, Department of Environmental Management, Fisheries and Wildlife Management, State Department of Agriculture, State Department of Forestry, and other land use management agencies. Most State land grant universities have faculty talent important to nutrient management, and almost all colleges and universities have applied science faculty with research interests and talents appropriate to this initiative. In selecting participants for the group, diverse expertise is an obvious prerequisite, but willingness to cooperate in the group effort, integrity, and a lack of a strong alternative interest are also important factors to consider for selecting these essential people who must make collective and sometimes difficult determinations.

The experts chosen will constitute the RTAG, which will be responsible for major decisions in regional implementation of the program. And the group should be sufficiently large to have the necessary breadth of experience, but small enough to effectively debate and resolve serious scientific and management issues. A membership of about 30 approaches an unwieldy size, although that number may initially be necessary to maintain an effective working group of half that size.

The RTAG is intended to be a regional, Federal agency advisory body consisting of a viable subset of scientists and resource managers from each pertinent agency as described above together with their State counterparts. The RTAG has a Federal responsibility and as such should not delegate or share this obligation with the private sector. The perspectives of private citizens, academicians, and special interest groups are important, and these and other members of the public may attend RTAG meetings and offer opinions when invited, but the final deliberations and decisions are the responsibility of the Federal and State members of the RTAG. They must also be able to meet and debate the issues without undue outside influence.

However, as a matter of policy, EPA encourages the RTAGs to regularly provide access and reports to the public. The meetings should generally be open to the public and the schedule of those meetings published in the local newspapers. At a minimum, RTAGs are encouraged to hold regular “stakeholders” meetings so that environmental, industrial, and other interests may participate via a separate public forum associated with responding to the group’s efforts. It is important that citizens and public groups be involved, and any significant determinations of the Group should include a public session at which a current account of activities and determinations is presented and comments acknowledged and considered. In addition, where specific land uses or practices are addressed, those property owners, farmers, fishermen, or other involved parties should be consulted in the deliberation and decisionmaking process.

It is reasonable to expect monthly or at least quarterly meetings of the RTAG, with working assignments and assessments conducted between these meetings. To coordinate activities among the 10 RTAGS, and with the National Nutrients Team, regular conference calls have been established. At these sessions, new developments in the Program, technical innovations and experiences, budgets, and policy evolutions will be conveyed and discussed. In the same context, an annual meeting of all Regional Nutrient Coordinators, State representatives, and involved Federal agencies is also held each spring in or

near Washington, DC. At this meeting, major technical reports are presented by specialists and issues significant to the Program are discussed.

The composition and coordination discussed above are intended to establish the shortest possible line of communication between the State, Region, and National Program staff members so that a rapid but reasoned response is promoted to changing issues and techniques affecting nutrient management of our waters. It is also designed to be responsive to the water resource user community without becoming a part of user conflicts.

#### *Delineation of Nutrient Ecoregions Appropriate to the Development of Criteria*

The initial step in this process has been taken through the creation of a national nutrient ecoregion map consisting of 14 North American subdivisions of the coterminous United States (Figure 1.3). These are aggregations of Level III ecoregions revised by Omernik (1998). Alaska, Hawaii, and the U.S. Territories will be subdivided into nutrient ecoregions later, with the advice and assistance of those States and governments.

The initial responsibility of each RTAG will be to evaluate the present ecoregional map with respect to variability based on detailed observations and data available from the States and Tribes in that EPA Region. This preliminary assessment of the nutrient ecoregional boundaries will further depend on the additional nutrient water quality data obtained by those States. The databases, especially with respect to selected reference sites, will be used to refine the initial boundaries of the map in each EPA Region.

It is expected that the collective effect of these evaluations by all 10 EPA RTAGs will result in the further refinement and subdivision of many of the 14 ecoregions, especially the large, multi-State ones. The boundaries will shift or be subdivided in accordance with the inherent trophic conditions and nutrient indicators of similar water bodies in each locality.

#### *Physical Classification*

The next step in evaluating the data is to devise a classification scheme for rationally subdividing the population of lakes in the State. Because identification of overenrichment is the objective of nutrient criteria development, trophic classification per se should be avoided, as should any classification based on levels of human development.

Physical characteristics independent of most cultural enrichment sources are far more appropriate. Such classification may be done initially on a size basis (e.g., acres of surface area or square miles of watersheds). A volumetric variable that may be used for further subclassification based on median or maximum depth. Similarly, inherent water quality characteristics such as marl or bog lakes may also apply. In fact, such lakes, especially if few in number, are usually separated out of the general population and identified as a separate and unique class. Hydroelectric reservoirs and effluent dominated systems are also examples.

Once lakes have been classified, it is important to determine how much information is available describing the enrichment status of these lakes. State agency records are the basis for an initial data

**Figure 1.3. Draft aggregations of level III ecoregions for the National Nutrient Strategy.**

search. In many States, water quality information resides in more than one agency. For example, Maryland has a Department of Natural Resources and a Department of the Environment, both of which retain water quality records. To compound the search further, States may also have pertinent data sets in their Departments of Fisheries and Public Health. It is wise to initiate the search for information with calls and questionnaires to colleagues in the State or Tribal agencies likely to be involved so an appropriate list of contacts and data sets can be compiled. In doing so, regional Federal agencies should not be overlooked either. These include the USFWS, Park Service, and U.S. and State Geological Surveys.

#### ■ Establishing an Appropriate Database (Chapter 4)

##### *Review of Historical Information*

Historical information is important to establish a perspective on the condition of a given waterbody. Has its condition changed radically in recent years? Is the system stable over time? Has there been a trend up or down in trophic condition? Only an assessment of the historical record can provide these answers. Without this information, the manager risks setting reference conditions and subsequent criteria on the basis of present data alone, which may in fact be a degraded state. Valid historical information places the current information in its proper perspective.

##### *Data Screening*

The first step in the process of either assessing historical observations and data sets or more current data is to review this material to determine the suitability of that information to support nutrient criteria development. Anecdotal information and observations are valuable, but the sources must be carefully considered. Fishermen's accounts, local sport fishing news stories, and the observational logs of scientific field crews are all legitimate sources of information, but they are subject to different levels of scrutiny before a trend is determined. The same applies to different databases. Nutrient information gathered for the purpose of identifying failing waste water treatment plants cannot be assessed in the same light as similar data collected to determine overall lake quality or trophic state. The analytical procedures used, type of sampling design and equipment, and sample preservation are other variables that must also be considered in any data review and compilation. Once this screening is done, the compiled data may be sorted according to named lakes or reservoirs.

##### *Nutrient Data Collection and Assessment*

EPA has initiated the data collection and assessment process by screening the existing STORET database for information on lakes, reservoirs, streams, and coastal waters with respect to four initial parameters of concern: total nitrogen (TN), total phosphorus (TP), chlorophyll *a*, and Secchi depth. These four parameters were originally selected for robustness and conservativeness of estimation; however the preliminary screening of the STORET data revealed that these measurements are also relatively abundant in the database. Although this is an entirely appropriate starting point for nutrient criteria development, States and Tribes are not required to confine their investigations and data selection for enrichment assessment and criteria development to only these variables.

States and Tribes are encouraged to select measures above and beyond these initial characteristics that contribute to the most appropriate and reliable assessment of the enrichment of the waters of their region. In particular, it is advisable to use both *causal indicators* (the nutrients introduced to the system especially species of nitrogen and phosphorus, and perhaps silica and carbon as indicated) and *response*

*indicators* (those measures of biotic productivity and activity reflecting the enrichment of the system) including chlorophyll *a*; Secchi depth; turbidity; algal taxa; plankton taxa; dissolved oxygen; macrophyte taxa, extent, and biomass; and fish taxa and numbers.

The combination of nutrient and biological system response information will yield the most definitive and comprehensive criteria. To use only causal or only response variables in the criteria leaves the State or Tribe in jeopardy of not protecting the waters from overenrichment. For example, an offensive water body covered with an algal scum may be low in the causal variables of reactive nitrogen and phosphorus because they are tied up in biomass (in fact, TN and TP were selected by EPA to avoid this problem). Therefore, the lake in question may meet those criteria, but not its designated or existing use. The converse may also occur, in which a highly enriched system with a rapid flushing rate appears to be acceptable when only the biota and dissolved oxygen are measured, but the load of nutrients being delivered downstream is degrading the receiving waters. Using a balanced combination of both causal and response variables in the criteria together with careful attention to seasonal variability should mitigate against these false positive and false negative results.

#### ■ Candidate Variables for Criteria Setting (Chapter 5)

EPA is beginning the National Nutrient Criteria Program with a survey of national computerized data sets such as STORET and NAWQA for TP, TN, chlorophyll *a*, and Secchi depth. These are believed to be the most common variables recorded with respect to enrichment investigations. The information will be screened for suitability and then plotted on regional maps of the United States for use by the Regional Nutrient Coordinators and RTAGs described above, and by the States. This being the case, it is reasonable for individual States and Tribes to begin with the same four indicators, although other causal and response variables are also discussed later in this manual (see Chapter 5).

#### ■ Establishing Reference Conditions (Chapter 6)

Candidate reference lakes can be determined from compiled data and with the help of Regional experts familiar with the lake resources of the area. There are two recommended ways to go about this. One is to select those lakes believed to be minimally impacted by human activity (e.g., with little or no riparian or watershed development). These lakes should be reviewed and visited to confirm their “natural” status. When satisfied with this list, a median value (adjusted for seasonal and spatial variation) for TP, TN, chlorophyll *a*, Secchi depth, and other appropriate enrichment indicators can be prepared for each lake based on existing and/or new data collections. The upper 25th percentile of the frequency distribution of these reference lakes can then be selected as the reference condition for each value (because these lakes represent the best obtainable and most “natural” condition, some allowance for variation should be made) (Figure 1.4(a)).

Another option is to plot the frequency distribution of all of the lake data presently available by each variable and selecting percentiles for TP, TN, chlorophyll *a*, Secchi depth, and other similarly appropriate variables. The lower 25th percentile, reflecting high nutrient quality can be selected as the reference condition for each value (because in this instance the pool of information likely includes lakes of considerably less than “natural” trophic condition) (see Figure 1.4(b)).

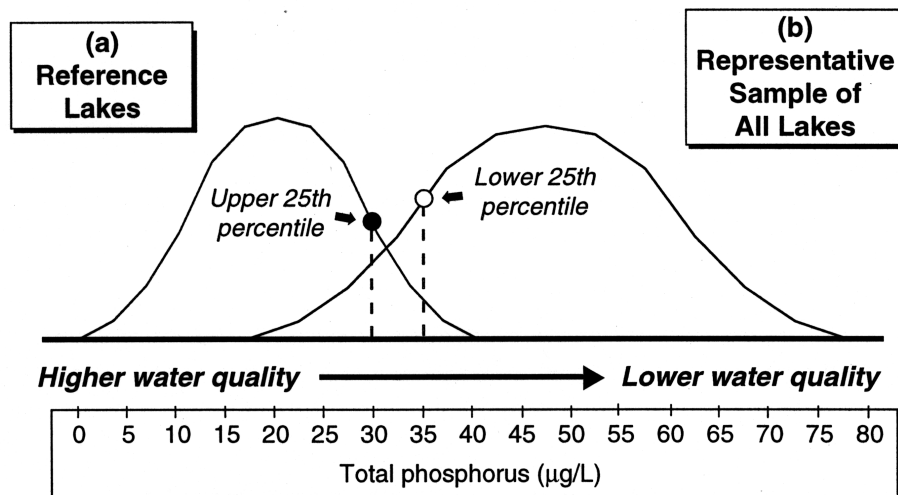

**Figure 1.4. Two approaches for establishing a reference condition value using total phosphorus as the example variable.**

The choice of the upper 25th and the lower 25th percentiles for the selected reference lakes and the random sample reference or census of all lakes in a class, respectively, is a rational but qualitative decision. It represents the effort to avoid imposing an undue penalty on high-quality mesotrophic lakes in regions where the lakes are predominantly oligotrophic. By selecting an upper percentile of the reference lakes, there is a greater likelihood that more of the broader population of lakes will comply.

Conversely, in regions of intense cultural enrichment, a lower percentile of the distribution of the remaining lakes used as reference must be selected to avoid establishing criteria based on degraded conditions. The quarterly increments were chosen as a reasonable division of the data sets recognizable by the public, and the upper 25th percentile and lower 25th percentile as reasonable and traditional fractions of the range and frequency of distribution. This approach promotes water quality enhancement and has broad application over the country.

Although these quantitative values are believed appropriate to the objective of the program, we recognize that some variation about such percentiles may be necessary. Certainly, in severely degraded areas even a 25th percentile may be insufficient, and some lower fraction of the remaining reference values may be required. On the other hand, where all lakes or reservoirs are in remarkably good condition relative to cultural enrichment, the acceptable fraction of the reference condition may be justifiably increased. The key point here is the presentation of a defensible scientific rationale for the determination. Otherwise, EPA presumes the above guidance will be appropriate.

It is intended that these two frequency distributions, with different quartiles, will produce a similarly appropriate reference condition—all other factors being equal. In either case, a number is generated that can be used as an initial reference preliminary to criteria development, and as a source of comparison for individual lakes in the class.



This is the beginning of the process that eventually leads to adoption of nutrient criteria as part of the State or Tribal water quality standards. Other factors that must be addressed along the way are gaps in the database that must be filled by additional data collections, possible biases in the data or data interpretation (especially if the information was originally collected for another purpose such as fishery management or waste water investigations), sampling errors by field teams, and equipment changes or measurement errors introduced by changes in analytical techniques.

## ■ Nutrient Criteria Development (Chapter 7)

### *Nutrient Criteria Components*

The move from data review and data gathering to criteria development involves a sequence of five interrelated elements:

- Examination of the historical record or paleolimnological evidence
- Compilation of reference condition data  
In situations where a class of lakes in question are all significantly impaired and none can be perceived as approximately “natural,” then the best quality remaining constitutes the present day example of a reference condition. In this instance the reverse of the earlier example of preselected minimally impaired reference lakes is true. Because most of the chosen lakes are assumed to be at least somewhat degraded, a lower percentile should be selected as a basis for the reference condition (e.g., the 25th percentile). To do otherwise is to ultimately lower the criteria to the level of present degradation and no restoration of the overenrichment condition will be achieved.

Remember that the present day reference condition is only part of the criteria development process; historical conditions, data extrapolations, and the best objective judgment of the RTAG, including concern for downstream impacts are the other components that will collectively establish the criteria.

- In some instances empirical modeling or surrogate data sets may be used where insufficient information exists. This may be the case especially with reservoirs or significantly developed watersheds.
- The objective and comprehensive interpretation of all of this information by a panel of specialists selected for this purpose (i.e., the RTAG). These experts should have established regional reputations and expertise in a variety of complimentary fields such as limnology, ecology, nutrient chemistry, and lake management.
- Finally, the criterion selected should first meet the optimal nutrient condition for that class of waterbody in the absence of cultural impacts and protect the designated use of that waterbody. Second, it must be reviewed to ensure that the level proposed does not entail adverse nutrient loadings to downstream waterbodies. In designating uses for a waterbody and developing criteria to protect those uses, the State or Tribe must take into consideration the water quality standards of downstream waters. This concern for downstream effect can be extended all the way to coastal waters, but in practice the immediate downstream receiving waters will be the area of greatest attention for the resource manager. This impact supersedes the level of optimal

enrichment for the target lake waters. If a downstream impact is expected, the criteria for that lake or class of lakes should be revised downward accordingly.

Once the initial criteria (either Regional or State/Tribal) have been selected, they can be verified and calibrated by testing the sampling and analytical methods and criteria values against waterbodies of known conditions. This ensures that the system operates as expected. This can be accomplished either by field trials or by use of an existing database the quality of which has been assured. This process may lead to refinements of either the techniques or the criteria.

It should be noted that criteria may be developed for more than one parameter. For example, all reference lakes of a given class may be determined to manifest characteristics of a particular level for TP concentration, TN concentration, chlorophyll *a*, and Secchi depth. These four measures will comprise four criteria levels appropriate to optimal nutrient quality. EPA expects a given test lake to meet or surpass these levels for at least TN and TP and one of the two response variables, and that a scientifically valid explanation will be derived for the remaining exception before it can be determined to meet the criteria. The policy for such application will be developed by the State or Tribe in consultation with EPA. The point here is that these four (or more) parameters used in this illustration are expected to be interrelated, and a consistent response for most if not all of them gives a level of confidence to the resource manager that he has evaluated the lake properly.

When the lake in question reveals high TN and TP concentrations, but not the expected high chlorophyll *a* or low Secchi depth measurements, further investigation is indicated before deciding on whether criteria have been met. Flushing rates or inorganic turbidity or water color may be additional factors influencing the condition of the lake.

#### *Assessing Attainment with Criteria*

A rule of compliance is then established for the criteria that have been selected for each indicator variable. The four initial variables include two causal variables (TN and TP) and two response variables (chlorophyll *a* and Secchi depth or a similar indicator of turbidity). Failure to meet either of the causal criteria should be sufficient to prompt action. However, if the causal criteria are met, but some combination of response criteria are not met, then there should be some form of decisionmaking protocol to resolve the question of whether the lake in question meets the nutrient criteria or not. There are two approaches to this:

- Establish a decisionmaking rule equating all of the criteria
- Establish an index that accomplishes the same result by inserting the data into an equation that relates the multiple variables in a nondimensional comprehensive score

With regard to more stringent State or Tribal criteria or standards, Agency policy on antidegradation generally requires that no lake or reservoir be allowed to degrade below its existing condition regardless of designated use or State or Regional criterion. (See Chapter 7, Section F, “Maintaining Existing Water Quality.”) This protects against the degradation of unique lakes of higher relative nutrient quality than might be stipulated in State or regional nutrient criteria.

## ■ Management Response (Chapter 8)

There are a variety of management responses possible to the overenrichment problem identified by the use of nutrient criteria. Chapter 8 describes a 10-step process that permits the resource manager to evaluate and select the best of these approaches to accomplish improvements in water resource condition. The emphasis is on developing a scientifically responsible, practical, and cost-effective management plan.

The chapter also describes three basic categories that encompass all management activities: education, funding, and regulation. It closes with the admonition to always carefully evaluate the relative success of the management project, report results, and continue monitoring the status of the water resource.

Finally, Chapter 9 and the appendices offer illustrations of the uses of models in the nutrient management process, a narrative description of the nutrient ecoregion map as presently developed, and examples of lake and reservoir nutrient management experiences. Future editions of this manual will incorporate actual Regional criteria values and State/Tribal accounts of their use of the manual for nutrient criteria development.

## CHAPTER 2

# The Basis for Lake and Reservoir Nutrient Criteria

- A. Historical Perspective
- B. The Nutrient Paradigm
- C. Connecting Watershed Loading to the Lake:  
A Mass Balance Model Approach
- D. Trophic State Classification Systems
- E. Uses of Trophic State Indices

### A. Historical Perspective

Large-scale comparative studies of lakes have enabled scientists to identify key variables that influence lake structure and processes (Peters, 1986). This empirical approach has its roots in regional studies (e.g., Naumann (1929) and Thieneman (1921)) and in early among-lake comparisons of lake function such as the role of morphometry on lake productivity (Rawson, 1955) and nutrient input regulation of lake fertility (Edmondson, 1961).

The eutrophication process was quantified by Vollenweider (1968, 1975, 1976), which brought the large-scale comparative approach to the forefront of limnology. Vollenweider developed a mass balance model using literature data from a diverse population of temperate lakes to demonstrate a surprisingly strong relationship between nutrient inputs to lakes and concentration of nutrients within the lake. This relationship was sufficiently powerful to stand out against other sources of among-lake variation and signaled that nutrient loading, as modified by hydrology, morphology, and in-lake sedimentation, was the dominant factor explaining lake eutrophication.

The element phosphorus was the focus of study because overwhelming evidence suggested that phosphorus limited algal growth in many aquatic systems (Schindler, 1977). Phosphorus values were highly correlated with algal biomass in lakes (Sakamoto, 1966); in turn, water clarity was shown to vary with algal levels (Edmondson, 1972). With these linkages quantified, the science of lake management arose around the premise that reductions in nutrient loads would reverse eutrophication, as measured by reduced nutrient concentrations, algal levels, and greater water clarity.

Empirical models provided limnologists with a quantitative basis for estimating the level of response to be expected from a given change in nutrient load from point and nonpoint sources. Models were the tools for forecasting the capacity of a lake to withstand change in its trophic state with various degrees of human development in its catchment (Dillon and Rigler, 1975). Recently, land use, as a surrogate for external nutrient loading, was used to effectively predict algal chlorophyll in lakes (Meeuwig and Peters, 1996); the strength of this approach stems from the strong correlation between nutrient losses and land use practices in catchments (Smart et al., 1985). This linkage of land use to chlorophyll, a widely accepted measure of lake trophic state, is additional evidence for the importance of external control on lake processes.

The large-scale comparative approach placed individual lakes within a continuum, from least to most fertile. With this understanding, lakes lost some of their individuality because scientists now viewed them within the context of this continuum. The functional relations between external nutrient loading, algal biomass, and water clarity were summarized in a small number of general models. These models were typically based on regression analyses of data from individual lakes, averaged over a sampling

season. The models quantified large-scale lake functions and provided the conceptual basis for lake management and restoration.

Because these early data were drawn from a diverse group of lakes, both in terms of lake type and geographic location, these models often are referred to as “global models.” An underlying assumption was that processes responsible for the large cross-sectional patterns in these global relations also operate within single systems over time (Prairie and Marshall, 1995). About the time of Vollenweider’s work, Edmondson (1972) applied virtually the same concepts to data covering the enrichment and recovery of Lake Washington. Edmondson’s work was tangible confirmation that a single lake responded to nutrient loading, as the pattern drawn from the data of many lakes would suggest. The remarkable feature during the 1970’s was that a quantitative paradigm for lake function had been proposed based largely on data drawn from the literature. It was a synthesis of ideas from earlier descriptive and empirical studies. A feature of predictions from empirical models was that there was a great uncertainty in them; many models exhibited an order of magnitude variation. This variation was a point of concern and the focus of subsequent study.

During the two decades since the empirical period of the mid-1970’s, lake management has been influenced by several major thrusts that have modified, but not invalidated, the work of that period. With expanded data sets over the past 20 years, the original global generalizations have been modified showing that in highly enriched lakes algal biomass does not increase in a uniformly linear relationship to phosphorus in all lakes (McCauley et al., 1989; Prairie et al., 1989; Watson et al., 1992) because other environmental factors also play a role. The Organization for Economic Cooperation and Development (OECD, 1982) project was an early effort to systematically gather data and quantify the relationship between nutrient load in waters and their trophic reaction. This project, composed of four regional studies (Alpine, Nordic, Reservoir and Shallow Lakes, and North American), attempted to corroborate Vollenweider’s generalizations. Its approach shifted the focus of among-lake comparisons from a global scale to studies within regions and studies of specific lake types.

Since then, several regional studies have used the comparative approach to generate empirical models specifically for local conditions. These regional studies have demonstrated the importance of other factors regulating algal biomass in lakes. Four other factors include nitrogen (Canfield, 1983; Pridmore, 1985), light limitation due to suspended solids (Hoyer and Jones, 1983; Jones and Knowlton, 1993), lake morphometry (Riley and Prepas, 1985), and grazing by herbivores (Quiros, 1990).

## **B. The Nutrient Paradigm**

The concept of nutrient criteria is based on the idea that nutrients produce changes in lakes and reservoirs that are considered to be detrimental to the function or use of the water body. This idea of nutrient control of water body function is not new; it can be traced back to when Einar Naumann, the Swedish limnologist, elucidated the major part of the nutrient paradigm in 1929. His ideas of the relationship between nutrients and lakes can be summarized in the following four statements:

- The primary factors that determine algal biomass (the amount of plant organic material) are the plant nutrients phosphorus and nitrogen.
- The geology (and land use) within the lake’s watershed determines the amount of nutrients that enter the lake and, therefore, plant biomass.

- Changes in the plant biomass affect the entire lake's biology.
- There is a natural ontogeny to lakes; the amount of plant biomass and, therefore, the entire biology of the lake increases as the lake ages.

Although there have been many significant additions and improvements in our understanding of lakes since Naumann, his original concept of nutrients remains the basis of the nutrient paradigm. Below, each statement is examined as it refers to the need for and the development of nutrient criteria for lakes.

### ***1. Phosphorus and Nitrogen as Limiting Factors for Algal Biomass***

The primary factors that determine algal biomass (production) are the plant nutrients phosphorus and nitrogen. When Naumann (1929) suggested this concept, he was probably drawing on a much older concept, Justus von Leibig's Law of the Minimum. The law, as it is formulated today, states that the factor that is in shortest supply relative to the needs of the plants limits the growth of those plants. The concept is central to the nutrient paradigm in lakes because it insists that very few factors (usually only one factor, often a plant nutrient such as nitrogen or phosphorus) will actually limit plant growth.

If only one factor, such as phosphorus, was always limiting, the task of developing nutrient criteria would be a simple matter of determining limits on that single factor. Unfortunately, the factor that limits plant biomass may (1) change seasonally or over longer periods of time, (2) vary depending on the land use, or (3) vary regionally. It would make little sense to construct a single nutrient criterion when that nutrient may not necessarily limit a target lake or lakes. It is for that reason that the emphasis of this document is the development of nutrient criteria based on both the nutrient inputs and the biological response.

The causal variables such as phosphorus and nitrogen are essential criteria because they will be the limits necessary to establish management objectives and are usually directly related to discharge runoff abatement efforts. Although phosphorus is the limiting factor for most lakes and reservoirs, in some regions the nutrient paradigm centers on nitrogen rather than phosphorus, especially where sewage treatment plant effluent is involved (Canfield, 1983; Pridmore, 1985; Jones et al., 1989). These regions are often in the subtropics or at high latitude or altitude (Wurtsbaugh et al., 1985; Morris and Lewis, 1988) but are also found in parts of Britain. In these lakes, nitrogen rather than phosphorus explains the among-lake variance in algal chlorophyll, and chlorophyll-total nitrogen regressions match the "fit and form" of chlorophyll-total phosphorus regressions developed for phosphorus-limited temperate lakes. The reason for nitrogen limitation is not yet understood because of a long-held tenet in limnology that states that nitrogen fixation will compensate for shortfalls (Schindler, 1977) and that nitrogen limitation is not a persistent condition. This belief does not seem as universal as once thought (Knowlton and Jones, 1996). In some regions, nitrogen limitation may be a function of abundant phosphorus in the geological formation of the region (Canfield, 1983).

Nitrogen limitation also may be tied to efficient nitrogen cycling in subtropical forests or may be a function of nitrogen uptake by rice and other crops in the subtropics. In high-elevation lakes, phosphorus may be contributed by soil weathering, whereas nitrogen is rare in these low organic soils. A recent literature review showed that nitrogen limitation was about as common as phosphorus limitation (Elser et al., 1990). Detailed water chemistry data from the midwestern lakes suggest that nitrogen values in the epilimnion fall during summer but that phosphorus values remain more constant. These data suggest phosphorus may be cycled more efficiently than nitrogen and that without external inputs, late summer nitrogen limitation can be expected. These results do not imply that continued focus on phosphorus for

eutrophication control is unwarranted; however, a better understanding of the frequency and extent of nitrogen limitation is needed to discern lake function. Nitrogen criteria as well as phosphorus criteria are appropriate.

Response variables such as chlorophyll *a* and algal or macrophyte species or biomass indicate the relative success of the nutrient management effort. By carefully incorporating both the causal and response elements, a State or Tribe should be able to fine-tune its criteria to meet the necessary enrichment levels for a given class of lakes. These variables are described in more detail in Chapter 5.

## ***2. Role of the Watershed***

The geology (and land use) within a lake's watershed determines the amount of nutrients that enter the lake and, therefore, plant biomass. This statement is probably the primary reason for the development of nutrient criteria: human activity in the watershed affects a lake's function. It is the reason behind the National Nutrient Assessment Workshop's conclusion that changes in land use can serve as an early warning system for changes in lakes (U.S. EPA, 1996).

In simplest terms, a lake's nutrient concentration is affected primarily by the rate of weathering and erosion from the soils in the watershed. If the underlying geological structure is granitic, then the rates of weathering will be low and both the productivity of the terrestrial vegetation and the concentration of nutrients in the runoff from the watershed will be low. On the other hand, if the underlying bedrock is sedimentary, the weathering rates will be higher and the fertility of the soil and the nutrient content of the runoff water will be higher as well. Consequently, Naumann (1929) observed that lakes in regions of sedimentary rock had higher algal densities (were greener) than lakes in granite-based watersheds. (For the purpose of this manual, atmospheric deposition of nitrogen and phosphorus, while possibly important, is accepted as a regional constant subject to further attention as our management technology improves.)

Human activity has at least two effects on the natural load of nutrient input to lakes: (1) it disturbs the overlying vegetation, exposing the soil to increased weathering and erosion, and (2) it adds easily erodible nutrient-containing material, such as fertilizers and animal waste, into the watershed. As the biological surface of an undisturbed watershed is disrupted, and as people move into the watershed, it can be expected that there will be increased soil and nutrient runoff.

Of course the degree of disturbance relative to the size of the lake will affect the impact of the disturbance; building a summer cottage would not have the same impact on a lake as would clear-cutting a forest or developing a condominium complex. Sometimes the term "assimilative capacity" is used to imply that the lake has a certain capacity to absorb the impact of disturbance. This concept, although comforting, probably has little basis in fact. Impact, until demonstrated otherwise, is probably better thought of as a continuous response to nutrient increases. The degree of change will depend on other factors, such as the size of the lake, and the change may not be immediately or even ever detectable to humans or their monitoring instruments. However, whether detected or not, changes do occur. It is for this reason that watershed disturbance is a sensitive early warning of lake change. Clearly, biological impact within the lake will be directly related to the increased amount of nutrient loading, and that impact will occur, whether or not it is detected.

Naumann (1929), nonetheless, used the relationship between nutrients and plants to establish a trophic state classification. He probably began his classification scheme with the perfectly reasonable goal of classifying lakes into those with low (oligotrophic) and high (eutrophic) plant biomass.

Oligotrophic lakes were clear with little algae, whereas eutrophic lakes were green. He then added to his classification system the causal factors that produced this degree of greenness, for example, the amounts of nitrogen or phosphorus. He called these the “factors of production.” Oligotrophic lakes were those that had low production (biomass) because they were low in nutrient concentrations. Eutrophic lakes were green because there were abundant nutrients to support the growth of algae.

The combination of the factors that affected production (causal factors) with plant production itself (response variable) allowed for a suite of trophic classes that dissected lakes into groups of varying production based on the factor or factors that were thought to limit that productivity. The classic oligotrophy-eutrophy axis was based on limitation by nutrients. The mesotrophic category was added to describe situations intermediate between oligotrophy and eutrophy. The term “hypereutrophic,” or hypertrophic, was added by Wetzel (1966) to describe situations of extreme eutrophy where light, not nutrients, is the dominant environmental factor controlling growth. This continuum of trophic states is illustrated in Figure 2.1.

### 3. Trophic Causal Chain

Naumann (1929) was very insightful in recognizing that the components of the lake are an interconnected system; as one component—the plants—responds to nutrient inputs, other biological, chemical, and even physical components would be affected as well. Increases in nutrient loading do not necessarily directly affect any component other than the plants, but by various pathways, other components of the lake ecosystem, such as zooplankton, fish, and hypolimnetic oxygen concentration, are affected as well. This trophic state cascade is depicted in Figure 2.2.

Because of these linkages between components, numerous variables may respond to varying degrees to increases in nutrients. Not only will algae or macrophytes increase, but zooplankton and fish biomass may increase as well, plant and animal species may change (with some going extinct), and hypolimnetic oxygen may be depleted. People react to the various changes or symptoms of lake condition reflected in the chemistry and biology that cascade from the change in loading, not directly to the change in loading or nutrient concentration itself.

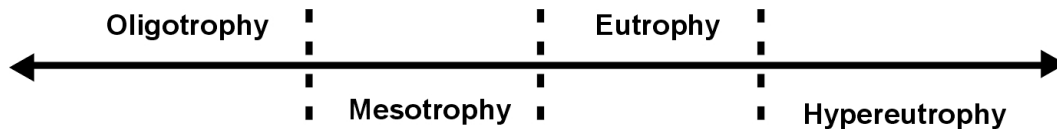
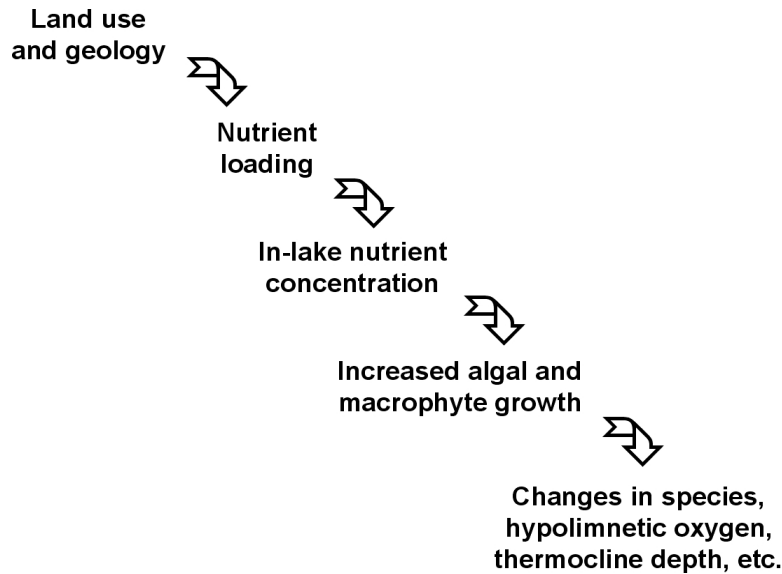

Figure 2.1. A trophic continuum.





**Figure 2.2. The trophic causal chain.**

This cascade of biological and chemical changes produces a variety of choices for the response variables needed to supplement the causal variables in the formulation of nutrient criteria. Choice of the response variable can be made based on sensitivity to change, cost of measurement and analysis, or importance to designated use.

#### **4. Lake Aging**

The idea that lakes undergo directional change in plant production as they age was probably related to the observation that shallower lakes appeared to have more plant biomass in them than deeper lakes. This observation later translated into the idea that increases in plant biomass were inevitable as a lake ages and fills in. This concept has led to terms such as “natural eutrophication” to describe inevitable increases in plant biomass as a lake becomes older and shallower. If natural eutrophication is thought to proceed at a rate related to inputs from the watershed, then we might expect to see accelerated rates of eutrophication if cultural influences occur in the watershed (cultural eutrophication).

If trophic state is a description of the biological condition of the lake, eutrophication describes a lake that is becoming more eutrophic (Figure 2.3). Specifically, it describes a change in the direction of eutrophy. A lake does not have to become eutrophic to have undergone eutrophication; it only has to move in the direction of eutrophy. Oligotrophication describes the process of a lake moving in the alternative direction, towards oligotrophy.

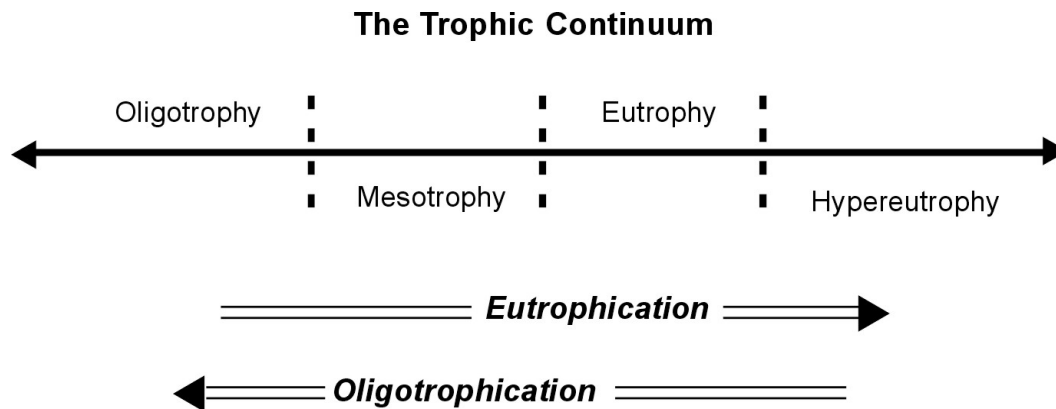

**Figure 2.3. Eutrophication and oligotrophication in relation to the trophic continuum.**

The term “nutrient enrichment” is in many, if not most, instances an alternative term for eutrophication. However, the emphasis in that term is on the increase in nutrients rather than on the lake’s response to that enrichment. If causal factors such as nutrient enrichment are closely linked via our terminology with the lake response, problems can arise if, for example, a lake’s biology changes without any change in nutrient loading or, conversely, if nutrient loading occurred without a coincident change in biology. These are not just hypothetical situations. The addition or removal of a benthivorous fish, such as bullhead or carp, can change the internal regeneration of nutrients and change the biological condition of the lake without any enrichment, or at least external enrichment, of the lake. The increase in grazing on algae because of the addition of a piscivore or the removal of the zooplanktivores also can alter the amount of plant biomass without the need of an alteration of nutrient loading. These manipulations, often called biomanipulations (Shapiro et al., 1975), are a type of lake manipulation that can alter the state of the lake without a change in nutrient load.

Natural eutrophication should not be confused with naturally eutrophic. The latter term describes lakes in watersheds where the natural load of nutrients is high despite the absence of human activity. Natural eutrophication describes a belief that lakes, presumably all lakes, have more plant material within them (become more eutrophic) as a natural part of becoming older.

The concept of natural eutrophication is probably correct to the extent that processes within the lake such as nutrient regeneration may enhance the effect of inputs from the watershed. The importance of these internal processes are still not well understood, especially along a gradient of lake aging. If becoming shallower were the only consideration, then the internal concentration of nutrient would increase only to a level as high as that in the incoming water. A lake in a watershed in which the concentrations of nutrients were very low in the incoming water would not become that much more eutrophic even if it did become shallower. However, a shallower lake also may have increased macrophyte growth and increased regeneration of nutrients from the sediments. In this case, the biological response would become increasingly independent of the external supply of nutrients.

A difficulty with dwelling on the possibility of natural eutrophication is that it emphasizes an inevitability of the eutrophication process; it also takes the focus off the immediate effects of the

watershed on the lake. Natural eutrophication is a process that is measured in terms of thousands of years, whereas the problems we encounter most often with lakes are the effects of processes that take only a few years to develop. Watershed disturbance can rapidly move a lake to a new level of nutrient concentration and biological response. More important, in most or many lakes, that response is, to some extent, reversible; we have not just moved rapidly down an irreversible path. Cultural eutrophication is, in fact, a reversible process, and nutrient criteria are an important element in this reversal.

### C. Connecting Watershed Loading to the Lake: A Mass Balance Model Approach

Like many earlier nutrient loading models, Vollenweider used a mass balance model for the basis of the prediction (see Chapter 9 Section B). Below is a basic review of Vollenweider's model and how it is used to link loading to concentration in a lake or reservoir.

The term "mass balance model" comes from the assumption that a substance such as phosphorus cannot just appear or disappear from a reservoir; it must come from somewhere and it must go somewhere. The phosphorus going into the reservoir must either go out again through some outflow, be sedimented to the bottom, incorporated into macrophyte biomass, or remain in the water in either dissolved or particulate forms. It is this phosphorus that remains in the water that is of interest because it is the amount that is available for algal growth.

Mass balance modeling is done in a manner similar to keeping a checking account. The total amount of phosphorus entering the reservoir (loading) each year is measured. Loading describes the total amount of material being moved in a stream in a given amount of time. The loading from any source ( $i$ ) is calculated as:

$$\text{Loading } (J_i) = \text{Water Discharge } (Q_i) \times \text{Concentration } (C_i)$$

or

$$J_i = Q_i C_i$$

The external loading, symbolized by Vollenweider by the letter J, can be calculated as the sum of the loading from all the external sources ( $i$ ) to the lake:

$$J = \sum_{i=1}^n Q_i C_i$$

Loading often is used to measure export of a nutrient or sediment from a watershed. For example, it is important to gauge the effects of farming practices on erosion, so we might calculate the tons of sediment removed from a watershed over a year. On the other hand, if the stream enters a lake or reservoir, we might want to know how much material is entering that body of water. In this case, nutrient loading might affect water quality, and sediment loading might affect the fill-in rate.

Predicting the internal concentration of a substance in a lake is also done using a mass balance equation. The appropriate mass balance for this prediction is based on the idea that the rate of change of the total amount of a material (M) in a lake ( $dM/dt$ ) is dependent on the total amount of material that enters a lake (J) and the total amount that leaves in the same time period:

$$dM/dt = (\sum Q_i C_i) - Q_o C_o$$

or

$$dM/dt = J - Q_o C_o$$

If the reservoir is not rapidly changing from one year to the next, the amount coming in one year should be equal to the amount going out:

$$\text{Inflow} = \text{Outflow} \quad (\text{i.e., } dM/dt = 0)$$

or

$$J = Q_o C_o$$

If we assume, as did Vollenweider, that the lake is completely mixed, then the lake concentration is equal to the outflow concentration:

$$C_{\text{lake}} = C_o$$

Therefore, the amount entering the lake will be equal to the amount leaving:

$$J = Q_o C_{\text{lake}}$$

Rearranging this equation, we obtain an equation predicting the concentration in the lake based on the external loading of the substance and the outflowing discharge of water:

$$C_{\text{lake}} = J/Q_o$$

Notice that the term  $(J/Q_o)$  has the units of concentration. Consider that it is the incoming loading divided by the outgoing water discharge.

This model is designed to predict the concentration of any conservative material. A conservative material, such as chloride or sodium, does not sediment within the lake basin, and the amount leaving the basin over the outflow should be equal to the amount entering. Conservative materials are not very interesting in themselves, but they are used as indicators of the accuracy of budgets of materials that do sediment within the lake. If the input of a conservative element is not equal to the output, then some other source of water and/or material has been neglected.

A nonconservative material, such as phosphorus, is one that is lost from the water column (e.g., sedimentation) within a lake basin. Because some material is lost from the water column, the input loading is not equal to the output loading. To model a nonconservative material, a sedimentation term must be added to the equation:

$$\text{Input} = \text{Output} + \text{Sedimentation}$$

Sedimentation was considered by Vollenweider to be proportional to the mass of the substance in the lake ( $M$ ). The total amount of material in the lake ( $M$ ) is calculated as:

$$M = C_{\text{lake}} V$$

where  $V$  = volume of the lake ( $\text{m}^3$ )

Vollenweider considered the amount of material lost to the sediments. This is designated by  $sM$ , where  $s$  is a first order fractional loss of the mass settled per unit time ( $1/t$ ) and  $M$  is the mass of substance in lake ( $C_{\text{lake}} V$ ). The sedimentation coefficient,  $s$ , is really a net sedimentation term, because the material may not only settle out of the water column but also may be resuspended into the column from the sediments.

The mass balance equation, with the added sedimentation term, becomes

$$dM/dt = J - Q_o C_o - sM$$

Vollenweider then assumed that over a calendar year the system would be near or at steady state, and the mass balance equation becomes:

$$J = Q_o C_o + sM$$

Note that all the terms still have the dimensions of amount per time.

An equation for predicting the lake concentration from loading can be produced by substituting  $C_{\text{lake}}$  for  $C_o$  (again assuming that the lake concentration is equal to the outflow concentration) and substituting  $C_{\text{lake}} V$  for  $M$ :

$$J = Q_o C_{\text{lake}} + s C_{\text{lake}} V$$

Rearranging, we obtain the predictive equation:

$$C_{\text{lake}} = \frac{J}{Q_o + sV}$$

The equation can be further rearranged into the form:

$$C_{\text{lake}} = \frac{J}{Q_o} \left[ \frac{1}{1 + sV / Q_o} \right]$$

With this equation, several things became clearer about loading:

- Vollenweider considers only the “total” form of the substance. He does not discriminate between dissolved and particulate forms.

- The term  $(J/Q_0)$  has the dimensions of concentration ( $\text{mg}/\text{m}^3$ ) and represents the average incoming concentration of the substance (Vollenweider, 1976) assuming evaporation is minimal. This term is sometimes replaced by a symbol for incoming concentration,  $C_i$ .
- The term  $(1/(1 + s(V/Q_0)))$  is really a description of the fraction of the incoming concentration that is *not* retained within the basin. In some models, retention is represented by the symbol  $R$  and the term  $(1/(1 + s(V/Q_0)))$ , by  $(1-R)$ .
- The term  $(V/Q_0)$  has the units of time and is the hydrologic residence time,  $T$  or  $t$ , which represents the average time that water remains within the lake.

Using these simpler symbols, the equation can be reduced to a simple statement of the relationship between loading and lake concentration:

$$C_{lake} = C_i \left[ \frac{1}{1 + sT} \right]$$

where  $C_i$  = average inflow concentration.

Although relatively simple, the equation illustrates the major aspects of prediction with mass balance models and trophic state:

- The concentration of a substance such as phosphorus in the reservoir ( $C_{lake}$ ) is directly determined by the concentration of that substance in the incoming streams ( $C_i$ ). The higher the concentration in the streams entering a reservoir, the higher the nutrient concentration will be in the reservoir itself.
- Internal factors such as water residence time ( $T$ ) and the net sedimentation coefficient ( $s$ ) determine the amount of material that is sedimented, and therefore lost, from the water column. The longer the water residence time, the greater the amount of material that will be sedimented within the reservoir, and the lower the reservoir concentration will be.

Additional terms have been added to the equation to account for release of a nutrient from the sediments into the open water or for the biological availability of the incoming phosphorus. These additional terms can make the predictions more specific to the particular reservoir being modeled. See Chapter 9 for a discussion of these models.

#### **D. Trophic State Classification Systems**

The concept of trophic state, with its relationship of the watershed to the chemistry and biology of the water body, has become one of the primary methods of classifying lakes. Despite controversies of definition, it has endured and probably will endure because of several important reasons:

- *History and tradition.* The language and implications of trophic state are deeply ingrained in limnology. In a sense the concept of trophic state is the nutrient paradigm.

- *Communication.* When a trophic state term, such as eutrophic or eutrophication, is used, there is a general agreement as to what a lake is like in terms of nutrients and biology. This implication of interrelationships tends to communicate far more information than can be implied with the statement of the value of a single variable.
- *Education.* The trophic state concept, even in qualitative terms, is a convenient vehicle to educate the public on the simplicity, and indeed the complexity, of the relationship between land use and the biological consequences.

Trophic state classification may have begun as a continuum concept, but it rapidly evolved into a classification of “types.” Most, but not all, existing trophic classification systems, or indices, reflect this typological emphasis. The representation of this type of classification scheme is simply of list of characteristics for a specific trophic type (Table 2.1). Lakes are assigned to a trophic class based on their agreement with the characteristics on the list. This type of classification runs into difficulty when specific variables may classify the lake in different categories. This happens when the correlation between variables is not strong.

The essence of a typological trophic classification is the belief that there is a real type of lake called eutrophic in the sense that there is a real type of human called young, middle aged, or elderly. Lakes can, therefore, be classified and placed into one of these types. Eutrophication is the progressive directional change of a lake out of one type and into another. Once in a type, the lake takes on certain characteristics by which it can be recognized and, therefore, classified. Such classifications are easily recognized from lists of characteristics typical for each trophic state heading (Table 2.1).

The OECD index (Vollenweider and Kerekes, 1980) used a statistical approach to quantify the ranges of several variables within each trophic designation (Table 2.2). This index was derived by asking a group of scientists their opinion as to what was the average value for each trophic class for each variable. The summarized data were used to produce bell-shaped curves for each variable for each class (Figure 2.4). The overlap that resulted emphasized that lakes of the same concentrations may be in more than one trophic class.

The second approach to trophic classification assumes that trophic types are not real but abstractions and, to some extent, arbitrary divisions of a continuum. This approach is similar to Naumann’s original classification. In this case, the discussions have been generally along the lines of what is the appropriate trophic state variable that should be divided into trophic state classes. The discussion of appropriate variables for classification is continued in Chapter 5.

Some continuum-based classification indices emphasize that trophic state reflects a number of variables, recalling the multiple variable approach of typological schemes. For example, Huber et al. (1982) stated that “trophic state is the integrated expression of the nutritional status of a water body. As such, it is widely accepted that no single trophic indicator or parameter is adequate to completely describe and/or quantify the concept.” Multiple variable indices differ from the typological indices largely in that they quantify the multiple variables found in the trophic state list of characteristics. These approaches emphasize the collection of quantitative data and are a major advance over qualitative listings.

**Table 2.1. Illustration of a Typological Trophic Classification System Based on Lake Characteristics (adapted from Rast and Lee, 1987)**

Variable	General Characteristics	
	Oligotrophic	Eutrophic
Total aquatic plant production	Low	High
Number of algal species	Many	Few
Characteristic algal groups	Greens, diatoms	Blue-greens
Rooted aquatic plants	Sparse	Abundant
Oxygen in hypolimnion	Present	Absent
Characteristic fish	Deep-dwelling, cold water fish such as trout, salmon, and cisco	Surface-dwelling, warm water fish such as pike, perch, and bass; also bottom-dwellers such as catfish and carp
Water quality for domestic and industrial use	Good	Poor

**Table 2.2. OECD Ranges Based on Scientists' Opinions (after Vollenweider and Carekes, 1980)**

Variable	Oligotrophic	Mesotrophic	Eutrophic
Total phosphorus mean range (n)	8 3-18 (21)	27 11-96 (19)	84 16-390 (71)
Total nitrogen mean range (n)	660 310-1600 (11)	750 360-1400 (8)	1,900 390-6100 (37)
Chlorophyll <i>a</i> mean range (n)	1.7 0.3-4.5 (22)	4.7 3-11 (16)	14 2.7-78 (70)
Peak chlorophyll <i>a</i> mean range (n)	4.2 1,3-11 (6)	16 5-50 (12)	43 10-280 (46)
Secchi depth (m) mean range (n)	9.9 5.4-28 (13)	4.2 1.5-8.1 (20)	2.4 0.8-7.0 (70)

Note: Units are  $\mu\text{g/l}$  (or  $\text{mg/m}^3$ ), except Secchi depth; means are geometric annual means (log 10), except peak chlorophyll *a*.



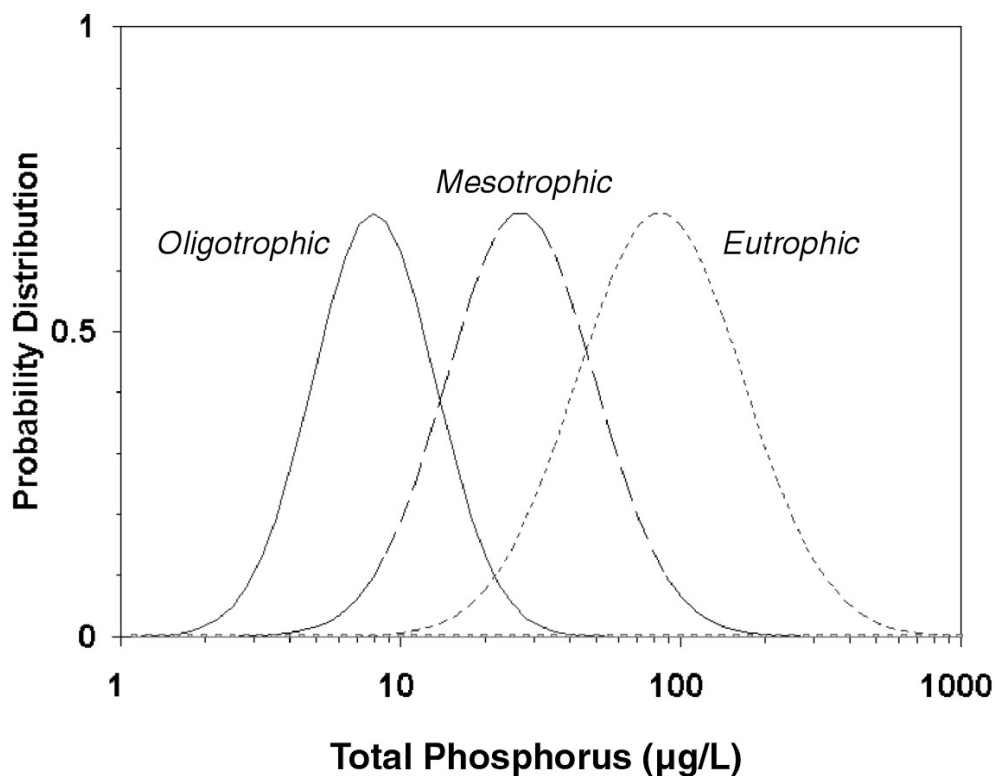

Figure 2.4. Probability distribution curves for total phosphorus by trophic status class.

Probably the most sophisticated of the multivariate indices is that of Brezonik and Shannon (1971), which uses principal components analysis to derive a trophic state index (TSI) based on seven variables: (1) TP, (2) primary production, (3) inverse of Secchi depth, (4) total organic nitrogen, (5) chlorophyll *a*, (6) specific conductance, and (7) the inverse Pearsall cation ratio ( $[\text{Ca}]+[\text{Mg}]/[\text{Na}]+[\text{K}]$ ). Other less sophisticated indices generally combine unweighted variables by one means or another. The EPA Index (U.S. EPA, 1974) ranked lakes based on “the percentage of the 200+ lakes exceeding Lake X in that parameter”; the index was “simply the sum of the percentile ranks for each of the parameters used.” The variables used were TP, dissolved phosphorus, inorganic nitrogen, Secchi depth (500-Value [inches]), chlorophyll *a*, and minimum dissolved oxygen ( $15\text{-DO}_{\text{min}}$ ).

These multivariate quantitative indices move trophic classification from a typological concept to one assuming a continuum of values, but they suffer from several drawbacks. The indices require that all the variables be measured before an index value is derived, thus greatly increasing the cost and analytical time required. A missing value eliminates a TSI determination. Changes in a single variable often will be overlooked in the index if other indices do not change. Conversely, if index variables are correlated, then a change in one may trigger a change in a number of variables causing an exaggeration of the amount of change. Finally, a change in the index does not tell the reader what has changed; information

is lost.

Carlson (1977) suggested returning trophic state to its first principles: a quantifiable plant biomass-based concept that could fit easily into existing and future nutrient and lake models. He did not redefine trophic state but used Naumann's (1929) original idea of a classification according to plant biomass. Instead of the distinct typological classes, Carlson assumed algal biomass to be from a continuous range of values. He suggested that the commonly used trophic classes were arbitrary divisions of the biomass continuum. To emphasize the continuum nature of a biomass-based trophic state, he used a numeric rather than a nomenclatural scale, dividing the range of algal biomass based on a doubling of Secchi depth, a variable that is affected by algal density.

The original Secchi depth equation in Carlson (1977), reproduced below, illustrates how the index was constructed:

$$TSI(SD) = 10 \left[ 6 - \frac{\ln SD}{\ln 2} \right]$$

The basic Secchi disk index was constructed from a doubling and halving of Secchi disk transparency. The base index value is a Secchi depth of 1 m, the logarithm of which is 0.

$$\ln 1 = 0$$

$$6 - 0 = 6$$

$$10 \times 6 = 60$$

Therefore, the TSI of a 1 m Secchi depth is 60. If the Secchi depth were 2 m,

$$\ln 2 / \ln 2 = 1$$

$$6 - 1 = 5$$

$$10 \times 5 = 50$$

The index utilizes relationships between trophic variables to produce equations that allow the index to be calculated from variables other than Secchi depth. The indices for the chlorophyll and TP are derived in a similar manner, but instead of a Secchi depth value in the numerator, the empirical relationship between chlorophyll or TP and Secchi depth is given instead. For example, the TSI equation for chlorophyll is:

$$TSI(CHL) = 10 \left[ 6 - \frac{2.04 - 0.68 \ln CHL}{\ln 2} \right]$$

The above forms of the equations illustrate how the indices were derived, but they can be simplified for everyday use:

$$\text{TSI (SD)} = 60 - 14.41 \ln \text{SD}$$

$$\text{TSI (CHL)} = 9.81 \ln \text{CHL} + 30.6$$

$$\text{TSI (TP)} = 14.42 \ln \text{TP} + 4.15$$

The value of multiple equations is that the same TSI value should be obtained no matter what variable is used to calculate it (i.e., a common scale). This means that if data are missing for chlorophyll, for example, a similar value could be obtained from transparency.

Although these three variables should covary, they should not be averaged because neither transparency nor TP are independent estimators of trophic state. Using transparency or phosphorus as an estimator of chlorophyll is very different from assuming equal and independent status of the variables. Secchi depth and TP should be used as a surrogate, not a covariate, of chlorophyll.

In essence, this TSI scale is an indexed scale of algal biomass. Because it is directly related to lake phosphorus concentration, it fits easily into phosphorus loading models such as that of Vollenweider (1976). If a loading model can predict phosphorus concentration in the water, then the trophic state can be predicted easily as well. Work by Kratzer and Brezonik (1981) allows the index to be predicted from nitrogen concentrations as well.

$$\text{TSI(TN)} = 54.45 + 14.43 \ln(\text{TN})$$

[Nitrogen values must be in units of mg/L]

Their index could be used especially if there is any indication that nitrogen, rather than phosphorus, is limiting.

## **E. Uses of Trophic State Indices**

Indices have several purposes. In some instances, indices take uncorrelated variables and aggregate them into a single word or value so that a general condition may be easily communicated. For example, a pollution index might include concentrations of heavy metals, pesticides, and phosphorus, which may or may not be correlated but could contribute to what the public considers to be pollution. The multivariate trophic state indices are of this type. These indices assume that trophic state consists of a number of possible attributes of lakes, ranging from nutrient concentration to hypolimnetic oxygen depletion. An index is necessary to somehow combine these various ingredients into the trophic stew and relate lakes to one another in a national continuum.

Alternatively, indices such as that of Carlson (1977) use the term “index” to mean that the variable measured is not trophic state, but an indicator of trophic state. For Carlson, trophic state is plant biomass. Chlorophyll, transparency, or even TP are variables that can estimate biomass but are really not living plant (autotroph) carbon. Even the measurement of organic carbon is not free from interferences from detritus or nonplant carbon. Trophic state is used as a surrogate for a real entity, plant biomass, that cannot be measured directly.

A third use of the term “index” that combines aspects of the first and second definition is that of simplification of a concept of measurement. For example, few readers know that the Richter scale, used to describe the magnitude of an earthquake, is the maximum deviation of a needle on a seismograph 62 miles from the epicenter. Actually, most people do not need to know the mechanics of calculating the Richter scale to have a sense of the severity of an earthquake. In the same sense, trophic state indices are shorthand methods to convey information. Total phosphorus or chlorophyll has little value in communication unless there is some standard to which the reader or listener can compare the value. In this case, saying eutrophic or TSI of 60 rather than “chlorophyll concentration is 20 µg/L” may convey information more easily because there are fewer terms to explain to an audience and fewer terms for the audience to put into the context of their own experiences.

In each of these instances, the index helps the reader equate several parameters in one indicator of enrichment condition so that an interpretation of condition is conveyed and conclusions can be made. Whether the measures of water quality compiled in a data set are used individually or collectively in an index, they are the essential, objective information the resource manager needs to determine the status of a lake or reservoir. With the representative information and a guide as benchmark criterion defining the relatively unimpaired and attainable water quality condition for comparison, the manager can classify, select, and plan for the restoration and protection of the lakes and reservoirs in his or her region.

## CHAPTER 3

- A. Defining the Resource of Concern
- B. Classification

# Preliminary Steps for Criteria Development

## A. Defining the Resource of Concern

Defining the resource of concern begins the overall process of establishing nutrient criteria. Resources of concern here are lakes and reservoirs, and managers must decide which water bodies are to be included in the population to which criteria will be relevant and applicable. Many States define jurisdictional lakes (“waters of the State”) as those above a size threshold. For example, the inclusion of farm ponds and other similar small ponds can potentially result in an inordinately large population of lakes that would be required to be considered during the criteria establishing process. These practical considerations often make it desirable to eliminate small water bodies from the resource population.

States may have already established a regulatory size threshold that specifies what should be considered a lake from the State management perspective. For example, the Florida Department of Environmental Protection routinely samples only lakes larger than 10 acres, because there are more than 7,000 lakes of 10 acres or more in Florida (Huber et al., 1982) and lakes under 10 acres are thought to number 10,000 or more. Florida surface water quality criteria apply to all lakes not wholly owned by a single person other than the State (Florida Amended Code, 62-340). States are encouraged to determine if the established threshold is appropriate for the nutrient criteria setting procedure described in this document and to adjust it as necessary. If States have not set size limitations that define a lake, State water resource agencies should evaluate the lake resources in the State to determine appropriate size limitations. The goal of such an exercise is to eliminate small water bodies that, because of their size (and resulting hydrology) or uses (e.g., small agricultural impoundments), do not accurately represent typical lake conditions or do not exhibit expected responses to stressors.

For the purpose of this document, lakes are defined as natural and artificial impoundments with a surface area greater than 10 acres and a mean water residence time of 14 or more days. Man-made lakes (i.e., artificial lakes) with the same characteristics may be viewed as part of the same system. Reservoirs are man-made lakes for which the primary purpose of the impoundment is other than recreation (e.g., boating, swimming) or fishing, and the water retention time and water body depth and volume vary widely. Hydroelectric power generation, drinking water supply, and flood control are examples of typical uses of reservoirs.

Impoundments on rivers, especially ones on larger rivers, also require specific definition. Impoundments behind low-head dams for navigation, as on the Ohio and Mississippi Rivers, are hardly lakelike in their characteristics; in fact, they are called navigational pools. At what point does a pool on a river become a lake? Limnologists generally consider lakelike characteristics to increase with water mean residence time. Many studies suggest that phytoplankton do not accumulate at retention times less than 7 days (e.g., Kimmel et al., 1990).

These definitions are provided for the purpose of illustration and consistency. States with legal definitions of their lakes or reservoirs should obviously adhere to their own terms and interpret this guidance accordingly.

## **B. Classification**

### ***1. Geographic Divisions***

The establishment of a single, national nutrient criteria for lakes is not a realistic goal because of the significant variability of water bodies that exist across the country in a variety of climates, geographic locations, and ecosystems. On a national basis, individual lakes and reservoirs are affected by varying degrees of development, and user perceptions of water quality can differ even over small distances. As a result, the nutrient criteria development process discussed in this document is based on an approach that acknowledges geographic differences in lakes across the country and within States and that uses a classification system to clarify those differences. The initial classification scheme used in this manual is the ecoregion approach (Omernick, 1987, 1988, 1995). However, many viable regionalization techniques exist for delineating geographic regions.

The process of identifying geographic divisions (i.e., regionalization) is part of a hierarchical classification procedure with the purpose of grouping similar lakes together (i.e., to prevent comparison of unlike lakes). Classifying lakes reduces the variability of lake-related measures (e.g., physical, biological, or water quality variables) within classes and maximizes the variability among classes. Classification invariably involves professional judgment to arrive at a workable system that separates clearly different ecosystems, yet does not consider each lake a special case. The intent of classification is to identify groups of lakes that under ideal conditions would have comparable characteristics (e.g., biological, ecological, physical). To the extent possible, classification should be restricted to those characteristics of lakes that are intrinsic, or natural, and are not the result of human activities. These characteristics include size, maximum or mean depth, detention time, and shape.

The general approach to the regionalization process is to establish divisions at the broadest level and then to continue to stratify to a reasonable point. In this section, a regionalization system for the national scale is presented to provide a framework for developing nutrient criteria. EPA encourages States to identify State-specific subregions, if appropriate, and to use the national regionalization scheme discussed below as the basis for further subdivisions.

#### **■ National Nutrient Ecoregions**

Ecoregions are a mapped classification system of ecological regions, that is, regions with assumed relative homogeneity of ecological characteristics (Omernick, 1987). EPA has developed maps of ecoregions of the United States at various levels of resolution and aggregation (Omernick, 1987). The most commonly used is the Level III ecoregions, consisting of 79 ecoregions in the conterminous United States. Ecoregions were based on interpretations of the spatial coincidence in all geographic phenomena that cause or reflect differences in ecosystem patterns. These phenomena include geology, physiography, vegetation, climate, soils, land use, wildlife, and hydrology. The relative importance of each characteristic varies from one ecoregion to another regardless of the hierarchical level.

For the National Nutrient Criteria Program, a map of aggregations of the Level III ecoregions was developed to define broad areas, within which there are general similarities in the quality and types of ecosystems as well as in natural and anthropogenic characteristics that affect nutrients (see Figure 1.1).

The regions are intended to provide a spatial framework for general guidance and reporting for the National Nutrient Criteria Program.

These nutrient regions and their component Level III ecoregions are described more fully in Appendix A. The nutrient regions delineated in Figure 1.3 are not intended to be homogeneous. They are aggregations of ecoregions where expectations within a nutrient region are more similar than expectations among nutrient regions. Some regions may be characterized by relative homogeneity; other regions may be characterized by extreme heterogeneity. An example of a heterogeneous region is Region XII, the Southern Coastal Plain, which has lakes ranging from ultra-oligotrophic lakes in sandy ridges and hills to highly eutrophic solution lakes in areas with phosphatic soils (Griffith et al., 1997). By comparison, Region VI, the Corn Belt and Northern Great Plains, is more homogeneous and is expected to be dominated by mesotrophic to eutrophic lakes, owing to the fertile plains soils and extensive agriculture. Region VIII, the Nutrient Poor Largely Glaciated Upper Midwest and Northeast, is dominated by oligotrophic lakes, but it also has small subregions with higher nutrient concentrations and mesotrophic lakes (Omernik et al., 1988; Rohm et al., 1995).

The nutrient regions can form the basis for initial development of nutrient criteria. Expectations can be developed for nutrient concentrations and loadings in each of the regions and criteria derived from those expectations.

#### ■ Further Subregionalization

The heterogeneity within many of the nutrient regions will require further subregionalization or subclassification to implement nutrient criteria. Using the ecoregion concept as a basis, EPA has developed lake regions based on phosphorus and other considerations for three areas: the Upper Midwest, comprising parts of nutrient regions VI, VII, and VIII in Minnesota, Wisconsin, and Michigan (Omernik et al., 1988); the Northeast, comprising nutrient regions VII, VIII, and XIV ranging from northern Pennsylvania and New Jersey through New York and the New England States (Rohm et al., 1995); and Florida, comprising a small part of nutrient region IX, most of Region XII, and all of Region XIII (Griffith et al., 1997). The regionalizations for the Upper Midwest and Northeast are based on total phosphorus concentration because of the dominance of phosphorus as the principal limiting nutrient in cool temperate lakes of the world (e.g., Schindler, 1978). The regionalization for Florida also takes into account total nitrogen concentration, algal chlorophyll, pH, color, Secchi depth, lake origin, and lake hydrology. In warm temperate and subtropical lakes, nitrogen concentration is often the principal limiting nutrient (e.g., Shannon and Brezonik, 1972; Carlson, 1992).

These subregionalizations were developed from data on nutrient concentrations of sampled lakes in the regions, soils, and land use (Omernik et al., 1988; Rohm et al., 1995; Griffith et al., 1997). The distributions of nutrient concentrations of each subregion were characterized (usually with a histogram) if data were available. In subregions where no data were available, the nutrient distributions were estimated based on similarity of soils and land use to regions where data were sufficient to characterize. It is expected that as more data are developed through the National Nutrient Criteria Program, more nutrient ecoregions will be similarly subdivided.

## 2. *Nongeographic Classifications*

Many lake classifications have been proposed in addition to trophic state and geography (Hutchinson, 1957). Lake classification can be further complicated by natural or human-induced conditions that can intrinsically affect the state of a lake and, therefore, how it can be classified. For

example, acidic lakes (whether naturally acidic or from acid deposition) are commonly found in the Adirondacks of New York, Pennsylvania, and West Virginia and in sand ridges of Florida. High mineral turbidity is found in reservoirs where streams have a high load of suspended fine sediment, typically in arid and semiarid regions.

Although lake types can be explained to greater or lesser extent on geographic considerations, it may be more convenient to classify lakes by nongeographic variables, which may yield more explanatory power than geographic locations. Discussed below are certain factors that potentially can affect the classification process but that generally fit the geographic-oriented focus of the above geographic approaches (e.g., ecoregional, water quality characteristic).

### ■ Lake Origin

Hutchinson (1957) lists 76 different types of lakes based solely on their origins. Although we often think of a lake simply as a hole in the ground with water in it, the number of different lake types should make us pause to consider how many ways the origin shapes the area, the volume, and the shape of the lake basin. Lakes of volcanic origin are probably very deep, with virtually no littoral zone and small watersheds. Crater Lake (lake type 10), for example, is extremely deep and very clear and has only the crater walls for a watershed. However, it is susceptible to nutrients introduced by septic leakage because of the very small water load.

Lakes of tectonic origin such as those found in faults (lake type 9; e.g., Lake Baikal) might behave similarly. Other lakes may be extremely shallow such as oxbow lakes (lake type 55) or maritime coastal lakes (lake type 64). In these instances, there may be extensive shallow areas and considerable interaction of the sediments with the overlying water. The shape of the basin and watershed help determine the controlling variables of surface area, depth, volume, and retention time. Rather than use discrete classes (e.g., large lakes, small lakes), it may be more effective to treat the shape-related variables as a continuous characteristic. This is discussed in more detail in Section 3.

### ■ Reservoirs

Reservoirs and impoundments, created by the damming of a stream, have characteristics of both rivers and lakes (Thornton, 1990). Reservoirs are divided into three zones—riverine, transitional, and lacustrine—which correspond to (1) flowing, riverlike conditions, (2) transition to lake conditions, and (3) nonflowing lakelike conditions near the dam, respectively. With expected life spans ranging from several decades to a century or more, reservoirs are more ephemeral than most natural lakes and have several physical characteristics unique to reservoirs and natural reservoirs formed by natural dams (e.g., beaver dams, terminal moraines, landslides).

Reservoirs vary widely in physical characteristics of shape, size, and hydrology. They can range from small, shallow impoundments (farm ponds) to deep storage reservoirs to “run of the river” flowthrough navigational pools and hydroelectric reservoirs on large rivers. They are built and managed for widely different purposes, including flood control, navigation, municipal or agricultural water storage, hydroelectric generation, and gamefish production. Many dams are constructed to allow discharge from the epilimnion, metalimnion, and/or hypolimnion, depending on management goals of the water bodies. This must be known before understanding the limnology of the reservoir. The management practices in turn affect physical, chemical, and biological characteristics of the reservoir.



Although no natural reservoir reference conditions exist, the operational determination of nutrient reference conditions for reservoirs is the same as for natural lakes. Reservoirs can be classified according to hydrology, morphometry, management objectives, and other factors. Age of the reservoir may be important in determining expectations. Several considerations affect the classification of reservoirs as opposed to natural lakes:

- *Distribution.* Reservoirs and impoundments are most numerous in regions with few or no natural lakes. The nonglaciated parts of North America have the largest number of reservoirs (except Florida, which is a Karst landscape).
- *Form.* The form or shape of a basin and watershed may be the most important distinction between natural and artificial lakes. Shape substantially influences hydrology and water quality of impoundments. Large reservoirs are drowned river valleys and tend to be long and deep with numerous embayments of tributary streams. The watersheds of reservoirs are relatively much larger than those of natural lakes and contribute relatively greater sediment loads.
- *Longitudinal gradient.* Reservoirs have characteristics typical of both lakes and streams. They are streamlike at the head where major tributaries enter and are more lakelike near the dam (Thornton, 1990).
- *Turbidity and loading.* Many reservoirs are more turbid than natural lakes, and they receive more nutrients and organic matter from their tributary streams than do natural lakes. This is partly related to the greater relative size of reservoir watersheds.
- *Management.* Reservoirs were built and are managed for specific purposes: hydropower, water supply, and flood control. Fisheries and other uses are usually secondary. Management might include extreme water level fluctuations and discharge depth controls, effects not present in most natural lakes.

Most of the differences between reservoirs and natural lakes are resolved in the classification of the lake resource. The needs for which they were designed dictate many of the attributes of artificial water bodies. Operational strategies can influence reservoir characteristics and resultant water quality (Kennedy and Walker, 1990; Kennedy et al., 1985). The release of water from deep in the water column (hypolimnetic release) increases heat gain and the dissipation of materials accumulated in bottom waters (Martin and Arneson, 1978; Wright, 1967). Surface releases dissipate heat and retain materials. These and other operational differences can provide a basis for grouping reservoirs within and among regions.

Relationships between why a dam is built, how and where it is built, how it is subsequently operated, and the characteristics of the resulting reservoir are reasonably well defined (Kennedy, 1999a). With regard to the establishment of nutrient criteria, can we utilize these relationships to define appropriate groups within which to identify reference conditions? Three categories of reservoir characteristics seem germane for this purpose: location within a drainage basin; structural and operational characteristics of the dam; and hydraulic residence time.

#### *Location in Drainage Basin*

Decisions about where dams are located broadly define physical attributes of the resulting reservoir, which, in turn, strongly influence its limnological character (Kennedy, 1999a). For example, tributary storage reservoirs are located on lower order rivers in the upland areas of drainage basins and, thus, often

reside in steeply sloping and dendritic basins with long, complex shorelines. Such reservoirs are frequently relatively deep and strongly stratified. Inflows are often lower for suspended sediment concentrations and may exhibit great seasonal or short-term variability. Changes in storage can result in marked changes in pool elevation, and water residence times are often long.

By contrast, run-of-the-river and mainstem storage reservoirs, frequently operated to meet navigation and hydropower objectives, are located on higher order river reaches. Run-of-the-river reservoirs often are limited in lateral extent to the areas immediately adjacent to the original river channel and seldom experience frequent or extensive changes in pool depth. Because they are commonly located at the downstream extent of large drainage basins, they receive high suspended sediment loads, are turbid, and flush rapidly. Dams for mainstem storage reservoirs, on the other hand, generally inundate broad river flood plains, offering extensive storage volumes. Despite relatively high inflow rates, water residence times can be long because of the large potential storage volume. Moderate changes in pool depth occur, and in-reservoir inorganic turbidity levels, while initially relatively high due to riverine influences, often are reduced because of long water residence times.

### *Dam Structure and Operation*

The purpose or purposes for which dams are built determine, in general, their structural design and their mode of operation. The location of outlet structures relative to the depth of the water column, as well as the thermal structure of the water column, determine the depth strata from which water is released. As discussed previously, withdrawal depth can have significant implications for reservoir thermal cycles and the expression of trophic responses to changing nutrient levels. Thus, interactions between reservoir depth, depth from which water is released, the volume of water released, and thermal structure of the water column must be considered when assessing relative similarities between reservoirs and lakes or among reservoirs.

As engineered systems designed to accomplish specific and often narrowly defined water control objectives, dams and the reservoirs they impound exhibit prescribed characteristics dictated by functional requirements. The scheduling of changes in reservoir volume (and, therefore, depth), for example, is determined by basin capacity, hydrology, and water uses. From an operational standpoint, this often involves the development and application of “rule curves,” or predetermined changes in reservoir surface elevation. For tributary storage reservoirs, particularly those operated for flood control, rule curves frequently require the lowering of surface elevations as a means to allow storage of subsequent flood waters, which may be retained for extended periods of time before their release downstream. The result is marked seasonal fluctuations in water column depth, reservoir volume, and water retention time.

Operational requirements for run-of-the-river reservoirs offer a contrasting example. Because the primary purpose of such reservoirs is navigation, reservoir surface elevations must be controlled within narrow limits. Thus, despite larger inflow volumes, rule curves for run-of-the-river reservoirs dictate minimal fluctuations in water column depth. In the absence of changes in water storage volume, water residence times are determined by hydrologic conditions and are uncoupled from dam operation.

From the above discussion and examples, it is obvious that dam structure and operation need to be considered when evaluating factors that influence the limnological attributes of reservoirs and the expression of trophic responses. In addition to their importance to the development of nutrient criteria, these relationships also describe potential management opportunities unique to reservoirs.

### *Hydraulic Retention Time*

Hydraulic retention time, defined as lake or reservoir volume divided by outflow rate and expressed as days or years, strongly influences limnological processes in lakes and reservoirs (e.g., Straškraba et al., 1993). These influences include changes in material retention rates (Straškraba et al., 1995; Kennedy, 1998), modifications to thermal structure, and impacts on the size and composition of planktonic communities (Straškraba and Straškrabova, 1975; Soballe and Threlkeld, 1985; Soballe and Bachmann, 1984).

Residence times vary widely between natural lakes and reservoirs and among reservoirs. Thornton et al. (1980) evaluated data for selected U.S. Army Corps of Engineers reservoirs and lakes contained in the National Eutrophication Survey database, and the authors reported significantly higher geometric mean values for lakes (270 days) than for reservoirs (135 days). A similar assessment of data included in the National Inventory of Dams (U.S. Army Corps of Engineers, 1998) indicates a broad range in water residence time for reservoirs impounded by U.S. dams (Kennedy, 1999b). Values for the nearly 65,000 reservoirs ranged from less than 1 day to more than 750 days; a similar range was observed for those operated by the Corps of Engineers. Many of those with short residence times are operated as run-of-the-river reservoirs for the purpose of navigation.

Ryding and Rast (1989) suggest that impoundment-related changes in water quality will occur when doubling times for algae are less than water residence times. Since Reynolds (1997) suggests that algal doubling rates are in the range of  $\frac{1}{2}$  to  $1\frac{1}{2}$  per day, it is clear that nutrient-related influences on trophic state are possible at relatively short water residence times. For reservoirs with longer residence times, anticipated differences in trophic responses between natural lakes and reservoirs will be minimized. In such cases, it may be possible to include both natural lakes and reservoirs with similar water residence times, assuming broad similarities in other attributes, in the same group when establishing reference conditions or developing nutrient criteria. In regions with a limited number of reservoirs, this will allow increased sample size for statistical treatments of the data.

On the basis of the above considerations, a reasonable and defensible approach to the identification of appropriate groups of reservoirs would employ multiple descriptors based on operational and physical attributes. Suggested measurement variables for each attribute are presented in Table 3.1. Taken together, this suite of physical and operational characteristics attempts to define factors influencing the expression of trophic responses to changing nutrient levels relative to reservoirs.

Therefore, reservoirs having short detention times should be considered separately from natural and man-made lakes because of their different origins, morphometry, and hydrodynamics. Reservoir studies have shown that the nutrient loading paradigm fits with some modifications (Canfield and Bachmann, 1981). The rapid flushing rates and longitudinal gradients that typify most mainstem reservoirs require modifications of the models to account for down-reservoir changes in water from sedimentation and dilution with passage through the system. Also, nutrient loading models that work well to explain in-lake concentrations in natural lakes overestimate values measured in reservoirs (Jones and Bachmann, 1978); for a given external load, reservoirs appeared to have lower in-lake phosphorus values than natural lakes. Differences between reservoirs and natural lakes were thought to be tied to the fact that reservoirs are constructed in erosional topography and receive much larger inputs of suspended solids than most natural lakes. With greater sediment input, it follows that reservoirs would have greater sedimentation rates and that more phosphorus would be lost from the water column as compared with natural lakes.

**Table 3.1. Categories and attributes for a Composite Classification Approach for CE Reservoirs and Suggested Measurement Variables (Kennedy, 1999b)**

Category	Attribute	Measured Variable
Location and size	Watershed dimension Reservoir dimension	Drainage area Location of dam in hydrologic continuum Surface area Volume Length Mean and maximum depth Shoreline development ratio
Hydrology	Hydraulic loading Storage dynamics	Inflow and outflow rates Annual/seasonal hydraulic retention time Pool elevation/volume Change in pool elevation
Structure and operation	Dam design Dam operation	Dam height Outlet depth (relative to water column depth) Quantity and seasonality of release volumes Depth of release
Other response effects	Light regime Mixing regime	Nonalgal turbidity Photic depth to mixed depth ratio Thermal stability Mixed layer depth

Another factor contributing to apparent differences in water column nutrient values is that reservoirs typically have large watersheds (Canfield and Bachmann, 1981). As a result, inflow enters from a parent river that, during stratified periods, forms a density flow below the warm surface water but above the colder bottom waters (tropholytic zone) that does not mix or contribute nutrients to the photic zone (Ford, 1990). Timing of nutrient-laden inflows relative to seasonal stratification can be as important as their volume in controlling nutrient values within the water column. Water bodies with density currents do not always show a response to external inputs. In these water bodies, loading models need to take into account the effects of inflow timing and flow stratification. The relative timing of flow and stratification will vary from year to year and could make nutrient content of the surface layer unpredictable except as a long-term average.

■ **Water Chemistry (nonnutrient)**

Intrinsic water chemistry (not including nutrients) can be used to classify lakes. The most likely variables include acid-base chemistry (any of alkalinity, pH, conductivity) and dissolved organic matter (water color). Color and pH are cheaply and easily measured in the field and are therefore highly cost-effective.

Lake water chemistry is largely determined by the hydrologic pathways of water entering the lake and the material the water contacts along its path. Lakes with large inputs of water from shallow ground water, including wetlands, tend to be stained yellow or brown with dissolved humic compounds. Water entering a lake as deeper ground water tends to be clear but will contain the cations of the soils and

aquifer. Highly colored lakes have been termed dystrophic because they often are observed to have low productivity in spite of moderate to high nutrient concentrations (Wetzel, 1975). Colored water not only reduces light penetration, but the dissolved organic matter also can chelate nutrients, making them unavailable for algal uptake. Therefore, water color is an important classification variable (or covariate; see below) for lake nutrient criteria.

Alkalinity also influences lake productivity, in part because alkaline soils are richer in several nutrients (especially phosphorus and potassium) than are acid soils, and because the nutrients are more readily available to plants. The world's most productive agricultural regions are in alkaline soils. Alkalinity, or its related variables pH and conductivity, are important classification variables for nutrient criteria. As an example, Florida lakes were characterized as acidic or alkaline and as colored or clear, resulting in four lake types (Shannon and Brezonik, 1972). Although pH and as color are continuous variables, it was more convenient to cluster the Florida lakes into four groups because response to nutrient enrichment and macroinvertebrate communities also clustered according to the four groups (Gerritsen et al., 1999).

### ■ Nonalgal Turbidity (suspended sediments)

High concentrations of nonalgal suspended materials are prevalent in lakes in many regions of the world and can inhibit growth of phytoplankton, causing light limitation. Nonalgal turbidity from suspended clay or organic matter is also strongly regional, depending on soil characteristics, vegetation, and hydrology. It is a prominent characteristic of many impoundments in Midwestern and arid Western States. Nonalgal turbidity can produce low algal chlorophyll-to-nutrient ratios and cause a lack of relationship between chlorophyll and phosphorus in some regions (Jones and Novak, 1981; Hoyer and Jones, 1983; Carlson, 1991; Jones and Knowlton, 1993). Light limitation of algal biomass in the mixed zone of lakes occurs when irradiance absorbed by the phytoplankton community is less than is required for net growth of biomass over time. Light limitation extended over periods of a week or longer is common in deep or turbid lakes during winter because of low incident light, but it is less common in summer when incoming irradiance is maximal and when mixing depth is reduced by thermal stratification.

The Carlson trophic state index (TSI) (1977) can be used to identify certain conditions in the lake or reservoir in which algal biomass is not related to phosphorus or nitrogen. When more than one of the three variables are measured, it is probable that different index values will be obtained. Because the relationships between the variables were originally derived from regression relationships and the correlations were not perfect, some variability between the index values is to be expected. However, in some situations the variation is not random, and factors interfering with the empirical relationship can be identified. These deviations of the total phosphorus or the Secchi depth index from the chlorophyll index can be used to identify errors in collection or analysis of real deviations from the "standard" expected values (Carlson, 1980b). Some possible interpretations of deviations of the index values are given in Table 3.2 (Carlson, 1983, 1992).

In turbid lakes, it is common to see a close relationship between the total phosphorus TSI and the Secchi depth TSI, while the chlorophyll index falls 10 or 20 units below the others. Clay particles contain phosphorus, and therefore, lakes with heavy clay turbidity will have the phosphorus correlated with the clay turbidity while the algae may neither utilize all the phosphorus nor contribute significantly to the light attenuation. This relationship of the variables does not necessarily mean that the algae is limited by light, only that the measured phosphorus is not all being utilized by the algae.

### 3. Covariates

Several of the above factors have strong influences on lake trophic state and may be expected to vary widely within nutrient regions. Whether a given factor needs to be considered separately in lake classification within regions depends on its variability in the region and its regional relevance in affecting trophic state. Additional classification factors may be treated as additional classes (e.g., as classes of large and small lakes) or as continuous covariates (e.g., a regression model to predict natural trophic state of lakes according to lake size). State and regional experts can use their knowledge of lake characteristics to determine if any of the modifying factors should be considered as part of a State-level classification scheme.

Lake morphometry and lake hydrology affect trophic state through the influence of water movement, retention time, and stratification. In-lake phosphorus dynamics in mixed and stratified lakes can complicate the relationship between external loading and measurements of lake trophic state, making model-based predictions uncertain in some cases. In mixed lakes, phosphorus has been shown to increase during the spring to summer period (Riley and Prepas, 1985), presumably because of recycling due to mixing of the water column and internal loading from the sediments (Osgood, 1988; Welch and Cooke, 1995). In contrast, it is typical for phosphorus to decrease somewhat in stratified lakes because of sedimentation processes, with the metalimnion acting as a barrier to upward transport into the photic zone.

Shallow lakes can efficiently cycle phosphorus and, under favorable light conditions, convert phosphorus into phytoplankton biomass. As a consequence of these internal loading mechanisms, shallow lakes do not always readily respond to reductions in external nutrient loading. Among large stratified lakes, evidence exists that the efficiency of nutrient recycling increases with lake size; mixed layers in large lakes are more turbulent and thicker than in small lakes, and these processes increase the probability of nutrient regeneration within the mixed layer rather than loss to the sediments. The response to greater nutrient regeneration is greater phytoplankton photosynthesis. These findings suggest that external nutrient loads should be converted into biological production more efficiently in stratified lakes than in small lakes.

Water residence time can have a significant effect on the amount of algae in the water. The water must remain in the basin for a period longer than the doubling time of the algae or the algae will wash

**Table 3.2. Conditions Associated with Various Trophic State Index Variable Relationships**

Relationship Between TSI Variables	Conditions
$TSI(CHL) = TSI(CHL) = TSI(SD)$	Algae dominate light attenuation
$TSI(CHL) > TSI(SD)$	Large particulates, such as Aphanizomenon flakes, dominate
$TSI(TP) = TSI(SD) > TSI(CHL)$	Nonalgal particulates or color dominate light attenuation
$TSI(SD) = TSI(CHL) > TSI(TP)$	Phosphorus limits algal biomass (TN/TP ratio greater than 33:1)
$TSI(TP) > TSI(CHL) = TSI(SD)$	Zooplankton grazing, nitrogen, or some factor other than phosphorus limits algal biomass

out of the basin. This means that for faster growing algae such as *Chlorella*, the water residence time would have to be at least 2 days. For slower growing species, the residence times would have to be much longer. In reservoirs with short residence times, the algae would not necessarily reach densities in which nutrients were limiting to their growth. However, residence time may vary seasonally, and there may be times when the algae do become nutrient limited. Another consideration would be that in short residence time situations, attached plants (both macrophytes and attached algae) may proliferate, and criteria would have to be set in reference to attached rather than planktonic forms.

Any continuous variable, such as pH, color, lake depth, or lake area, can be treated as a covariate in a classification. Often, it may be more convenient to treat them as discrete classes (large and small; acid and alkaline). Whether to treat an important classification variable as discrete classes or as a continuous covariate may depend on the size of the database, the distribution of lakes across the gradient, and whether the trophic response to the gradient is linear. For example, a uniform or unimodal distribution across a gradient would suggest treating the variable as a covariate (e.g., lake surface area), while a bimodal distribution would suggest dividing into classes (e.g., pH classes of acidic and nonacidic lakes). If a relationship is found between measures of lake size or hydrology and trophic state, then additional classes reflecting these factors, or treating them as a covariate, must be considered. Because relationships with morphometric variables are often linear, the covariate approach usually is preferred for those variables (area, depth, retention time). Conversely, water chemistry variables (pH, color, hardness) may cluster naturally due to geology, soils, and vegetation, so the class approach may be preferred for those variables.

### **Case Study: Ecoregional Classification of Minnesota Lakes**

Minnesota has over 12,000 lakes spread across diverse geographic areas. Previous studies had shown distinct regional patterns in lake productivity associated with regional differences in geology, vegetation, hydrology and land use (Heiskary and Wilson, 1989). Minnesota contains seven ecoregions (Omernik, 1987), and four of the ecoregions contain 98 percent of the lakes. These four ecoregions are the Northern Lakes and Forest (NLF), North Central Hardwood Forest (NCHF), Northern Glaciated Plains (NGP), and Western Corn Belt Plains (WCBP) (Figure, p. B-4). Minnesota uses these ecoregions as the framework for analyzing data, developing monitoring strategies, assessing use patterns, and developing phosphorus goals and criteria for lakes (Heiskary, 1989).

The Minnesota Pollution Control Agency (MPCA) and several other groups collected data on chlorophyll *a* concentrations and several water quality parameters (total phosphorus, total nitrogen, and Secchi transparency) in 90 reference lakes between 1985 and 1987. Secchi transparency data were collected mostly by volunteer participants in the Citizen Lake Monitoring Program. Reference lakes were chosen to represent minimally impacted sites within each ecoregion. Criteria used in selecting reference lakes included maximum depth, surface area, fishery classification, and recommendations from the Minnesota Department of Natural Resources (Heiskary and Wilson, 1989). Lake morphometry had previously been examined. In addition to the reference lake database, MPCA examined a statewide database containing data collected by these same groups on approximately 1,400 lakes from 1977 to 1987.

Differences in morphology, chlorophyll *a* concentrations, total phosphorus, total nitrogen, and Secchi transparency were found among lakes in the four ecoregions in both studies. Lakes in the two forested ecoregions (NLF and NCHF) are deeper (median maximum depth of 11 meters) with slightly smaller surface areas (40 to 280 ha) than those in the plains ecoregions (NGP and WCBP). Lakes in the two plains ecoregions were typically shallow (median maximum depth of 3 meters) with larger surface areas (60 to 300 ha).

Box-and-whisker plots for chlorophyll *a* and water quality measurements in the reference lake study paralleled the morphological differences seen among the ecoregions (Heiskary and Wilson, 1989). The two plains ecoregions had significantly higher chlorophyll *a* levels than either of the two forested ecoregions. Results of the statewide database analysis showed these same trends. The results of these two database analyses support the use of ecoregions in developing frameworks for data analysis, monitoring strategies, assessing use patterns, and developing phosphorus goals and criteria for lakes.



# CHAPTER 4

## Establishing an Appropriate Database

- A. Introduction
- B. Evaluating Existing Data
- C. New Data Collection
- D. Database Management

### A. Introduction

The development of nationwide regional nutrient criteria requires the availability of an extensive amount of data from across the country for evaluation. Data may come from existing sources or can be collected from new sampling programs. Nutrient-related data for lakes and reservoirs, collected by various agencies for many different purposes, exist in various databases and have the potential to provide the basis for the development of nutrient criteria on a regional level. This chapter presents an overview of existing nutrient criteria databases and presents a general discussion on the evaluation of such data in terms of their use in the nutrient criteria development process. The chapter also provides a description of the process undertaken by EPA to use existing data from STORET and perhaps other existing data sets (e.g., U.S. Geological Survey [USGS] NAWQA) to generate preliminary nutrient criteria on an ecoregional level. In addition to discussing the use of existing data, the chapter discusses new data collection, including sampling design and the types of monitoring to be considered as part of data collection activities. The chapter ends with a general discussion of data management issues that are integral in the overall discussion of data storage and accessibility.

### B. Evaluating Existing Data

In many States, historical data on lakes are extensive and may be sufficient to identify lake classes and reference lakes and to establish interim criteria. With societal interest in cultural eutrophication during the 1970's—programs such as EPA's Clean Lakes Program (CLP) and citizen's organizations such as LakeWatch—lakes have been extensively monitored and studied. Many historical data are available and may suffice for developing lake nutrient criteria. Although existing data may be sufficient, program managers should recognize that gathering, reducing, analyzing, and interpreting existing data sets can be costly and time consuming.

Development of nutrient criteria using the reference site approach requires a database that can be used to characterize (1) reference lakes and (2) the biological response of lakes to nutrient enrichment. At a minimum, observations should include total nitrogen (TN) (or Kjeldahl nitrogen plus  $\text{NO}_2\text{-NO}_3\text{-N}$ ), total phosphorus (TP) (or total dissolved phosphorus plus particulate phosphorus), chlorophyll *a*, and Secchi depth. For each lake in the database, there should be information or inference on the status of anthropogenic nutrient loading to the lake. At a minimum, this information would be informed best professional judgment on whether anthropogenic nutrient loading was negligible or substantial for a given lake. The judgment could be based on personal observation, discharge information, land use information, or historical information. Such information may not reside together with the water quality observation and may need to be found and obtained separately.

As mentioned above, the water quality data should be sufficient to characterize a lake. All lakes in the database should have been sampled the same way and should be characterized the same. Ideally, lakes will have been sampled once during an index period that characterizes nutrient or trophic state (e.g.,

during spring overturn) and with sampling methods that are assumed to characterize the lake (e.g., pumped or composite sample of the entire water column). Some existing data sets may permit estimation of annual or growing season average nutrient concentrations.

Appropriate data analysis will be determined by the data set. The basic procedure is to consider each lake an independent sample unit and to estimate an annual characteristic value (annual average, median, minimum, maximum) of each water quality observation for each lake. These annual characteristic values are the information used to develop nutrient criteria and biological response of lakes to enrichment. This procedure assumes that lakes are independent and that annual averages among years are independent. The investigators and the Regional Technical Assistance Groups should decide whether the independence assumptions are reasonable and whether any modifications should be made.

### ***1. Potential Data Sources***

Databases could include water quality monitoring data from water quality agencies (often stored in STORET), national surveys such as the EPA Eastern Lakes Survey (Linthurst et al., 1986) or the Environmental Monitoring and Assessment Program (EMAP) (Paulsen et al., 1991), limnological studies, and volunteer monitoring information.

#### **■ STORET**

STORET is EPA's national data warehouse for water quality data. All State and Federal water quality monitoring agencies are required to submit their data to STORET. STORET is huge, covering all 50 States since the 1970's; it includes lakes, streams, rivers, and estuaries and physicochemical and biological data. STORET has no quality control for accepting or rejecting data, but it does require extensive metadata (data descriptors) that show how data were collected and what analytical methods were used. All sampling sites are referenced by latitude and longitude, by the EPA Reach File 3 (RF3), and by USGS hydrologic unit codes. Extracting data from STORET requires familiarity with the system as well as selection criteria (date ranges, location ranges, specified measured variables, collecting agency with known quality control) to keep from being overwhelmed with irrelevant data.

#### **■ National Eutrophication Survey (NES)**

EPA conducted NES in the early 1970's. Several hundred lakes were sampled and nutrient budgets were estimated. The lakes selected for the survey received discharges from municipal sewage treatment or the States requested they be included. NES contains a broad but incomplete sample of lakes, and therefore, the data from NES are not sufficient in themselves for developing reference conditions to support regional nutrient criteria. The NES data may be used for determining biological responses to enrichment and for developing site-specific criteria.

#### **■ National Surface Water Survey (NSWS)**

EPA conducted NSWS in the mid 1980's under the National Acid Precipitation Assessment Program. Lakes were surveyed only in those regions where they were initially thought to be at risk to acid precipitation: New England, the Adirondacks, the mid-Atlantic highlands, the mid-Atlantic coastal plain, the southeastern highlands (southern Appalachians and Ozark-Ouachitas), Florida, the upper Midwest, and the montane West. NSWS sampled 2,300 lakes ranging in size from 4 to 2,000 hectares; thus, the smallest and largest lakes were not represented. NSWS was a stratified random sample of lakes in the

selected region; therefore, inferences can be made to the populations defined by the regions. Sampling took place in the fall. Nutrients were measured, so NSWS data could be used to help develop criteria.

#### ■ **Environmental Monitoring and Assessment Program**

EPA's EMAP sampled lakes in New England and the Adirondacks in 1991, with a probability-based site selection procedure to obtain an unbiased sample (Paulsen et al., 1991). Further similar work is planned in the western States. The EMAP lake sample should include potential reference lakes as well as stressed lakes and could be used to identify reference lakes and characterize reference conditions.

#### ■ **Clean Lakes Program**

The EPA CLP for restoring public lakes included a monitoring and assessment component. Lakes in this program were selected because they were perceived to have water quality impairment. Like data in the NES database, these data must be carefully scrutinized before being included in a database setting regional reference conditions to support nutrient criteria.

#### ■ **Volunteer Monitoring Programs**

- Individual State Lake Association Programs that may contain considerable information, may be contacted through the National Directory of Environmental Monitoring Programs (contact: Alice Mayo, U.S. EPA headquarters, Washington, DC).
- National data on Secchi disc transparency have been collected since 1994 by the "Secchi Dip-In" (Carlson et al., 1997).

Elements of these databases could contribute to criteria development but, like the EMAP data, would need to be screened to identify reference and nonreference lakes.

#### ■ **State Monitoring Programs**

Most States monitor some subset of lakes and impoundments within their borders for eutrophication and nutrient variables. Several of the more extensive lake monitoring programs (e.g., Minnesota, Wisconsin, Maine, Florida) are profiled in this document as examples of using monitoring data to help develop nutrient criteria. The purpose of the survey should be assessed before using the data. See Representativeness, in Section 2 below.

#### ■ **U.S. Army Corps of Engineers**

The U.S. Army Corps of Engineers is responsible for more than 750 reservoirs. Extensive monitoring data have been collected for many of these reservoirs that could contribute to the development of nutrient criteria for reservoirs.

#### ■ **U.S. Department of the Interior, Bureau of Reclamation (BuRec)**

The Bureau of Reclamation manages many irrigation and water supply reservoirs in the West. Data from their operations may be available for some of these.

## ■ Electric Utilities

Many electric utilities own reservoirs for hydroelectric power generation, and the utilities are required to monitor the reservoirs' water quality. The largest of these, the Tennessee Valley Authority, has extensive chemical and biological monitoring data from most of its reservoirs from the early 1980's to the present.

## 2. *Quality of Historical Data*

The quality of older historical data sets is a recurrent problem because the data quality is often unknown. This is especially true of long-term repositories of data such as STORET and long-term State, academic, commission, or municipal databases, where objectives, methods, and investigators may have changed many times over the years. The most reliable data tend to be those collected by a single agency using the same protocol for a limited number of years. Supporting documentation should be examined to determine the consistency of sampling and analysis protocols.

When “mining” from large heterogeneous data repositories such as STORET, investigators must screen data for acceptance considering a number of variables, as discussed below.

## ■ Location

STORET data are georeferenced with latitude, longitude, and RF3 codes. These can be used to select specific locations or specific USGS hydrologic units. In addition, STORET often contains a site description. If selecting, for example, all lake sites within a geographic region, it is also important to know the rationale and methods of site selection by the original investigators. Such information may be included in STORET metadata, if known.

## ■ Variables and Analytical Methods

Thousands of variables are recorded in STORET records. Each separate analytical method yields a unique variable (called parameter in STORET); thus, five ways of measuring TP results in five unique variables. Because methods differ in accuracy, precision, and detection limits, it is generally unwise to mix methods in the same analysis. If there is one method that the investigator judges to be best, then only observations using that particular method can be selected. Selection of a particular “best” method may result in too few observations, in which case it may be more fruitful to select the most frequent method in the database. Some data may be missed because some methods may be synonymous, and there is an unknown component of error from incorrect data entry.

## ■ Laboratory Quality Control

Laboratory quality control data (blanks, spikes, replicates, known standards, etc.) are generally not reported in the larger data repositories. It is more cost-effective to accept or reject all data of the collecting agency or laboratory based on overall confidence of their quality control. Overzealousness in eliminating lower quality data can be counterproductive, because the increase in variance caused by analytical laboratory error may be negligible compared with natural variability or sampling error, especially for nutrients and related indicators.

### ■ Collecting Agencies

STORET data are identified by the agency that collected the data. Selecting only data from particular agencies with known, consistent collection and analytical methods and known quality will reduce variability due to unknown quality problems.

### ■ Time Period

Long-term records are critically important for establishing trends. In characterizing reference conditions for nutrient criteria, it is also important to determine if trends exist in the reference site database. For example, since passage of the Clean Water Act and elimination of most discharges to lakes, many lakes have improved markedly. Other lakes, subject to increased nonpoint-source runoff, may have declined in overall quality.

### ■ Index Period

If nutrient and water quality variables were measured more than once a year, an index period for estimating average concentrations must be set. The index period may be the entire year, spring or fall mixing (in regions where lakes stratify), or the summer growing season. The best index period is determined by investigators considering the characteristics of lakes of the region, the quality and quantity of data available, and estimates of temporal variability (if available).

### ■ Representativeness

Data may have been collected for specific purposes, such as developing nutrient budgets for eutrophic lakes. Such data are unlikely to be representative of the region or lake type of interest. The investigator must ask whether the lakes in the database are representative of the population of lakes to be characterized. If not, can a subset of representative lakes be selected from the database? If a sufficient sample of representative lakes (i.e., one large enough to characterize reference conditions) cannot be found, a new survey will be necessary (see section C below).

## 3. *Data Reduction*

To facilitate data manipulation and calculations, it is highly recommended that historical and present-day data be transferred to a relational database. Relational databases are powerful tools for data manipulation and initial data reduction (calculation of seasonal means, etc.). They allow selection of data by specific multiple criteria (e.g., all observations June–September in reference lakes of low alkalinity), calculation of means and totals by criteria, and definition and redefinition of linkages among data components.

Data reduction requires a clear idea of the analysis that will be attempted and a clear definition of the sample unit for the analysis. For example, a sample unit might be defined as “a lake basin during June–September.” For each variable measured, a mean value would then be estimated for each lake basin in each June–September index period on record. Analyses are then done with the observations (estimated means, medians, or modes) for each sample unit, not with the raw data. Steps in reducing the data include:

- Selecting the time period for analysis
- Selecting equivalent depths of sampling
- Selecting an index period to characterize lakes
- Selecting relevant chemical measures:
  - Quality of methods
  - Combining data from different methods
- Estimating values for analysis (mean, median, mode, minimum, maximum) based on the reduction selected

### C. New Data Collection

When present-day and historical data do not exist or are inadequate for meeting desired objectives, collecting new monitoring data may be the only remaining alternative. A well-designed monitoring program is essential for establishing nutrient criteria in lakes. Monitoring data are needed for a variety of purposes, from the initial classification of lakes to assessing the effectiveness of controls. This section presents a brief background on statistical issues to consider when designing a monitoring program and provides recommendations for three types of monitoring associated with nutrient criteria.

Several manuals and statistics books are available that provide information on sampling design. The following manuals deal specifically with the sampling of lakes and reservoirs:

- Carlson, R., and J. Simpson. 1996. *A coordinator's guide to volunteer lake monitoring methods*. North American Lake Management Society. February 1996.
- Gaugush, R.F. 1986. *Statistical methods for reservoir water quality investigations*. Instruction Report E-86-2, U.S. Army Engineer Waterways Experiment Station, Vicksburg, Mississippi.
- Gaugush, R.F. 1987. *Sampling design for reservoir water quality investigations*. Instruction Report E-87-1, U.S. Army Engineer Waterways Experiment Station, Vicksburg, Mississippi.
- Reckhow, K.H. 1979. *Quantitative techniques for the assessment of lake quality*. U.S. EPA Office of Water Planning and Standards. EPA-440/5-79-015.
- Reckhow, K.H., and S.C. Chapra. 1983. *Engineering approaches for lake management. Volume 1: Data Analysis and Empirical Modeling*. Ann Arbor: Butterworth Publishers (Ann Arbor Science).

#### 1. Types of Monitoring Associated With Nutrient Criteria

Monitoring is a critical component of nutrient criteria development and implementation. Monitoring is necessary after criteria are developed to determine trends and efficacy of water quality management in lakes and to improve the criteria with better information. If historical or existing data are not suitable for developing nutrient criteria, then a field survey is necessary to acquire the relevant data. More intensive diagnostic surveys and monitoring would be necessary if a lake did not meet its nutrient criteria, followed by long-term monitoring to determine if the management actions succeeded. Nutrient criteria thus are supported by three types of monitoring surveys: classification survey monitoring, diagnostic monitoring, and evaluation monitoring.

#### ■ Classification Surveys to Support Nutrient Criteria Development

The purpose of a classification survey is to gather data that can be used to classify lakes or reservoirs into groups (classes) or along gradients with unique expected trophic status and trophic responses to enrichment. Classification depends on acquiring a database of lakes covering a gradient from least

altered (reference lakes) to most altered in the region. The goal of the classification survey process is to identify classes of lakes independent of cultural eutrophication, that is, classes that would be recognizable if human cultural eutrophication were absent or minimal. Because the objective is to develop nutrient criteria, each lake class identified should have a unique suite of trophic conditions, as well as a unique response to cultural eutrophication, that sets each class apart from the other classes. Classes need not be discrete categories of lakes; classification also may identify natural environmental gradients rather than categories.

Existing regional lake databases potentially can be sufficient for classification in many regions of the country, as has been done in Minnesota (Heiskary et al., 1989) and Florida (Griffiths et al., 1997). However, if adequate data do not exist, new data should be collected.

#### *Parameters to Survey*

As many as possible of the water quality response parameters discussed in Chapter 5 (e.g., TP, TN, chlorophyll, Secchi depth, and dissolved oxygen) should be sampled during classification monitoring. In addition, classification also requires collecting information that helps explain observed patterns, including region (e.g., ecoregion or lake region); watershed size; lake water characteristics such as pH, conductivity, alkalinity, total suspended solids, and color; watershed land use; and human population density.

#### *Sampling Frequency*

Because the objective of classification monitoring is to characterize a large population of lakes, a single determination per lake may be the most cost-effective method (e.g., Linthurst et al., 1986). Multiple sample times (e.g., monthly) will yield a more precise estimate of annual average concentrations, but these must be weighed against the cost of sampling. For a given monitoring budget, it may be possible to sample 12 lakes 1 time for the same cost as sampling 1 lake 12 times. North temperate lakes or reservoirs are most effectively sampled during spring turnover for mass balance modeling. However, in general, ecoregional trophic state criteria will be indexed by EPA to the time period of optimal vegetative growth. This approach also is recommended for State and tribal sampling.

#### *Sampling Location*

Several alternatives are possible for sampling sites within lakes: single site (often the deepest point of the lake), multiple sites, spatially composite samples from multiple locations in a lake, or spatially composite samples from multiple sections of large lakes. Sampling location and frequency will affect not only the cost of the program but also the inferences that can be made from the sample. In general, composite samples are more cost-effective (information gained per dollar spent) than single sites or multiple locations.

To facilitate comparison, EPA recommends using the same spatial site location and discrete or compositing methods for both the classification survey and routine maintenance monitoring. If increased power is required for certain kinds of maintenance monitoring (see below), then the frequency of sampling should be increased, but the methodology should not be changed. Diagnostic investigation has entirely different objectives, so consistency with the classification sampling and maintenance monitoring is not necessary.

A single site may be chosen as the midpoint of the central basin of the lake, and this site may be sufficient to classify lakes within a region. The location of this single site should remain constant from one year to the next so that comparisons can be made during routine monitoring.

Composite samples are taken from several sites in a lake or lake zone and combined into a single sample for laboratory analysis. For example, water samples may be taken from four sites in a lake and poured into a single clean bucket. The composite sample is subsampled for chlorophyll *a* and nutrients. However, Secchi depth, temperature, and dissolved oxygen are measured at each of the four sites. Care must be taken that the methods and volume sampled are the same at each site. Composite samples characterize the lake better than a single sample, and they save laboratory costs. The principal disadvantage of composite samples is that they do not allow estimation of spatial variability within a lake.

Because large riverine reservoirs have known gradients of nutrients and productivity from the river inflow to the dam (Kennedy and Walker, 1990), a single site will not be appropriate. Large reservoirs would require a minimum of three sites, corresponding to the riverine, transitional, and lacustrine zones. Alternatively, and depending on reservoir design and size, sampling may be from the discharge or composited from the deepest portion of the reservoir. (See also Chapter 7, Section C, regarding a data reduction approach to ecoregional criterion.)

### ■ Diagnostic Monitoring

Diagnostic monitoring provides more detailed information on a specific lake or reservoir and allows the manager to identify key problems and develop an appropriate management plan. Diagnostic monitoring is carried out before and during lake restoration efforts, such as took place in the Clean Lakes Program. This process is more fully described in Chapter 8.

### ■ Evaluation Monitoring

The purpose of evaluation monitoring is to provide continuing information on the condition of a lake or reservoir. It can be used to determine if a lake is continuing to meet its nutrient criteria or to assess the effectiveness of any management controls that have been implemented. The level of effort required for evaluation monitoring is considerably less than for diagnostic monitoring. Examples of evaluation monitoring include operational lake monitoring by many State water quality agencies and volunteer monitoring efforts. Evaluation monitoring is discussed in more detail in Chapter 8.

Each of these monitoring objectives requires a statistically appropriate design to meet its objectives. The three types of monitoring are not entirely distinct, because data gathered for one purpose can be used for other purposes. Distinguishing between the different types of monitoring simply points out the need to identify ahead of time the purpose of the monitoring to maximize available resources.

## *2. Sampling Design*

### ■ Specifying the Population and Sample Unit

Sampling is statistically expressed as a sample from a population of objects. In some cases, the population is finite, countable, and easy to specify—for example, all lakes in state X, where each lake is a single member of the population. In other cases, the population is more difficult to specify and may be infinite—for example, lake waters of State X, where any location in any lake defines a potential member



of the population (Thompson, 1992). Sampling units may be natural units (entire lakes, cobbles in a littoral zone), or they may be arbitrary (plot, quadrat, sampling gear area, or volume) (Pielou, 1977). Finite populations may be sampled with corresponding natural sample units, but often the sample unit (e.g., a lake) is too large to measure in its entirety, and it must be characterized with one or more second-stage samples of the sampling gear (bottles, benthic grabs, quadrates, etc.)

Each sample unit is assumed to be independent of other sample units. The objective of sampling is to best characterize individual sample units to estimate some attributes (e.g., nutrient concentrations, dissolved oxygen) and their statistical parameters (e.g., mean, median, variance, percentiles) of a population of sample units. The objective of the analysis is to be able to say something about (estimate) the population. It is critical to distinguish between making an inference about a population of many lakes (“Reservoirs in the Blue Ridge are deep and oligotrophic”) versus an inference about a single lake (“Lake has fewer fish species than unimpaired reference lakes”). These two kinds of inferences require different sampling designs: The first requires independent observations of many lakes and does not require repeated observations within sample units (pseudoreplication) (Hurlbert, 1984); the second inference often requires repeated observations within a lake. Examples of sample units include:

- A point in a lake (may be characterized by single or multiple sample device deployments). The population then would be all points in the lake, an infinite population.
- A constant area (e.g., square meter, hectare). The population could be all square meters of lake surface area in a State or region.
- A lake or a definable subbasin of a lake as a single unit. Because lakes are most often discrete environments, this is likely to be the most common sample unit. The population would be all lakes in a State or region, a finite population.

### ■ Specifying the Reporting Unit

It is also necessary to specify the units for which results will be reported. Usually, this is the population (e.g., all lakes), but often subpopulations (e.g., lakes within a given nutrient ecoregion) and even individual locations (e.g., lakes of special interest) will be specified. To help develop the sampling plan, it is useful to create hypothetical statements of results in the way that they will be reported, for example:

- Status of a place: “Lake X is degraded.”
- Status of a region: “20% of the lake area in State X has elevated trophic state, above reference expectations”; “20% of lakes in State X have elevated trophic state.”
- Trends at a place: “Nutrient concentrations in lake X have decreased by 20% since 1980.”
- Trends of a region: “Average lake trophic state in State X has increased by 20% since 1980.”; “Average trophic state index values in 20% of lakes of State X have increased by 15% or more since 1980.”

- Relationships among variables: “50% increase of phosphorus loading above natural background is associated with decline in taxa richness of benthic macroinvertebrates, below reference expectations”; “Lakes receiving runoff from large impervious parking lots have 50% greater probability of elevated trophic state above reference conditions than lakes not receiving such runoff.”

### ■ Sources of Variability

Variability of measurements has many possible sources. The intent of many sampling designs is to minimize the variability caused by uncontrolled or random effects and, conversely, to be able to characterize the variability caused by experimental or class effects. For example, lakes may be stratified by soil phosphorus content of the surrounding watersheds (e.g., Kiilsgaard et al., 1993) so that lakes within a soil phosphorus class may be likely to have similar water column TP concentrations. The population of lakes is stratified so that observations (sample units) from the same stratum will be more similar to each other than to sample units in other strata.

Environmental measures vary across different scales of space and time, and sampling design must consider the scales of variation. In lakes, measurements of some variable such as TP or chlorophyll concentrations are taken at single points in space and time (center of the lake, 2 m depth, 10 a.m. on 2 July). If the same measurement is taken at a different place (littoral zone, 1 m), lake, or time (30 January), the measured value may be different. A third component of variability is the ability to accurately measure the quantity in which we are interested, which can be affected by sampling gear, instrumentation, errors in proper adherence to field and laboratory protocols, and choice of methods used in making determinations.

The basic rule of efficient sampling and measurement is to sample so as to (1) minimize measurement errors; (2) maximize the components of variability that have influence on the central questions and reporting units; and (3) control other sources of variability that are not of interest, that is, minimize their effects on the observations. In the example of chlorophyll concentrations, variability could be reduced by sampling each of several lakes in the deepest part, with a vertically integrated pump sample taken in early spring before stratification appears. Many lakes are sampled to examine and characterize the variability due to different lakes (the sampling unit). Each lake is sampled in the same way, in the same place, and in the same timeframe to minimize variability caused by location, depth, and season, which are not of interest in this particular study.

In the above example, chlorophyll concentrations vary with location within a lake and among lakes and with time of sampling (day, season, year). If the spatial and temporal components of variability within lakes are large (e.g., measurements of chlorophyll concentrations typically vary more between spring and fall samples within a lake than they do among lakes), then it may be best either to use an index period sample or to estimate a composite from several determinations. For this reason, lake chlorophyll concentrations often are estimated as a growing season average, estimated from several determinations (e.g., monthly) during the growing season.

In statistical terminology, there is a distinction between sampling error and measurement error that has little to do with actual errors in measurement. Sampling error is the error attributable to selecting a certain sample unit (e.g., a lake or a location within a lake) that may not be representative of the population of sample units. Statistical measurement error is the ability of the investigator to accurately characterize the sampling unit. Thus, measurement error includes components of natural spatial and temporal variability within the sample unit as well as actual errors of omission or commission by the

investigator. Measurement error is minimized with methodological standardization: selection of cost-effective low variability sampling methods, proper training of personnel, and quality assurance procedures to minimize methodological errors. In analytical laboratory procedures, measurement error is estimated by replicate determinations on some subset of samples (but not necessarily all). Similarly, in field investigations, some subset of sample units should be measured more than once to estimate measurement error.

Analysis of variance can be used to estimate measurement error. All multiple observations of a variable are used (from all lakes with multiple observations), and lakes are the primary effect variable. The root means square error (RMSE) of the analysis of variance is the estimated variance of repeated observations within lakes. Note that a hypothesis test (F-test) is not of interest in this application, only the RMSE of the analysis.

Natural variability that is not of interest for the questions being asked, but that may affect the ability to address them, should be estimated with the RMSE method above. If the variance estimated from RMSE is unacceptably large (i.e., as large or larger than variance expected among sample units), then it is often necessary to alter the sampling protocol, usually by increasing sampling effort in some way, to further reduce the measurement error. Measurement error can be reduced by multiple observations at each sample unit, for example, multiple ponar casts at each sampling event, multiple observations in time during a growing season or index period, depth-integrated samples, or spatially integrated samples.

A less costly alternative to multiple measures in space is spatially composite determinations. In nutrient or chlorophyll determinations, a water-column-pumped sample, where the pump hose is lowered through the water column, is an example of a spatially composite determination. Spatially integrating an observation and compositing the material into a single sample is almost always more cost-effective than retaining separate multiple observations. This is especially true for relatively costly laboratory analyses such as organic contaminants and benthic macroinvertebrates.

Statistical power is the ability of a given hypothesis test to detect an effect that actually exists, and it must be considered when designing a sampling program (e.g., Peterman, 1990; Fairweather, 1991). The power of a test ( $1 - \beta$ ) is defined as the probability of correctly rejecting the null hypothesis ( $H_0$ ) when  $H_0$  is false (i.e., the probability of correctly finding a difference [impairment] when one exists). For a fixed confidence level (e.g., 90%), power can be increased by increasing the sample size or the number of replicates. To evaluate power and determine sampling effort, an ecologically meaningful amount of change in a variable must be set.

Optimizing sampling design requires consideration of tradeoffs among the measures used, the effect size that is considered meaningful, desired power, desired confidence, and resources available for the sampling program. Every study requires some level of repeated measurement of sampling units to estimate precision and measurement error. Repeated measurement at 10% or more of sites is common among many monitoring programs.

### ■ Alternative Sampling Designs

Sampling design is the selection of a part of a population to observe the attributes of interest. To estimate the values of those attributes for the whole population, classical sampling design makes assumptions about the variables of interest. In particular, it assumes that the values are fixed (but unknown) for each member of the population until that member is observed (Thompson, 1992). This assumption is perfectly reasonable for some variables—for example, length, weight, and sex of members

of an animal population—but it seems less reasonable for more dynamic variables such as nutrient concentrations, loadings, or chlorophyll concentrations of lakes. Designs that assume that the observed variables are themselves random variables are model-based designs, in which previous knowledge or assumptions are used to select sample units.

### *Probability-Based Designs (random sampling)*

The most basic probability-based design is simple random sampling, in which all possible sample units in the population have the same probability of being selected, that is, all possible combinations of  $n$  sample units have equal probability of selection from among the  $N$  units in the population. If the population  $N$  is finite and not excessively large, a list can be made of the  $N$  units, and a sample of  $n$  units is randomly selected from the list. This is termed list frame sampling. If the population is very large or infinite (such as locations in a lake), one can select a set of  $n$  random  $(x,y)$  coordinates for the sample.

All sample combinations are equally likely in simple random sampling; thus, there is no assurance that the sample actually selected will be representative of the population. Other unbiased sampling designs that attempt to acquire a more representative sample include stratified, systematic, and multistage designs. In stratified sampling, the population is subdivided or partitioned into strata, and each stratum is sampled separately. Partitioning is typically done so as to make each stratum more homogeneous than the overall population; for example, lakes could be stratified on ecoregion. Systematic sampling is the systematic selection of every  $k$ th unit of the population from one or more randomly selected starting units, and it ensures that samples are not clumped in one region of the sample space. Multistage sampling requires selection of a sample of primary units, such as fields or hydrologic units, and then selection of secondary sample units, such as plots or lakes within each primary unit in the first-stage sample.

Estimation of statistical parameters requires weighting of the data with inclusion probabilities (the probability that a given unit of the population will be in the sample) specified in the sampling design. In simple random sampling, inclusion probabilities are by definition equal, and no corrections are necessary. Stratified sampling requires weighting by the inclusion probabilities of each stratum. Unbiased estimators have been developed for specific sampling designs and can be found in sampling textbooks, such as Thompson (1992).

### *Model-Based Designs*

Use of probability-based sampling designs may miss relationships among variables (models), especially if there is a regression-type relationship between an explanatory and a response variable. As an example, elucidation of lake response to phosphorus loading with the Vollenweider model (Vollenweider, 1968) required a range of trophic states from ultraoligotrophic to hypereutrophic. A simple random sample of lakes is not likely to capture the entire range (i.e., there would be a large cluster of mesotrophic lakes with few at high or low ends of the trophic scale), and the random sample may therefore be biased with respect to the model.

In model-based designs, sites are selected based on previous knowledge of auxiliary variables, such as estimated phosphorus loading, lake depth, and elevation. Often, these designs preclude an unbiased estimate of the population response variable (e.g., trophic state), unless the model can be demonstrated to be robust and predictive, in which case the population value is predicted from the model and from previous knowledge of the auxiliary (predictive) variables. Selection of unimpacted reference sites is an example of samples for a model (index development; response of index variables to measures of

anthropogenic influence) that cannot later be used for unbiased estimation of the biological status of lakes. Ideally, it may be possible to specify a design that allows unbiased estimation of both population and model. Statisticians should be consulted in developing the sample design for a nutrient criteria and monitoring program.

#### **D. Database Management**

Critical to the success of any monitoring and criteria development program is comprehensive data management. Because agencies that engage in water quality management are required to be accountable, because monitoring and assessment tools continue to be developed, and because desktop computers are now capable of many of the same tasks as larger computers, data management must be addressed at the outset of a program or project. Storing data in filing cabinets or on spreadsheet files is no longer adequate.

The most powerful database architecture for storing large, complex data sets with multiple relationships among the data elements are relational databases. The hierarchical nature of a watershed and a survey and assessment program are reflected in a relational database: a watershed may contain many sampling sites; each site may be sampled multiple times during an investigation; and each sample may be tested for multiple constituents.

Nonrelational databases consist of one or more flat files. Examples include text files and spreadsheet files. Flat file databases have a number of disadvantages, including redundant data, maintenance difficulties, and slow access to data. A number of relational database management systems (i.e., software) exist today, including Oracle, Sybase, DB2, Informix, SQL server, and ACCESS.

In the simplest form, a relational database begins as a collection of tables. Each table is related to at least one other table through one or more key fields that act as links (i.e., relationships) between tables. Because tables are related, information can be retrieved from more than one table at a time. Tables generally contain data about a particular subject. For instance, data about a station that is sampled would be in one table, whereas data about a sampling event would be in a separate but related table. Good database design includes reducing or eliminating duplicate information in tables and being able to make changes to the database tables as data needs change. Data should be easy to manage, aggregate, retrieve, and analyze. EPA has sponsored the development of two relational databases that are available for data management for nutrient criteria, modernized STORET and Ecological Data Application System (EDAS).

##### ***1. Modernized STORET***

EPA's Office of Water has redesigned and modernized STORET. The historical data contained in STORET, BIOS, and ODES are available in modernized STORET. This database was designed to meet emerging data and information needs associated with watershed level environmental protection. The features of the new system were carefully engineered to meet the information requirements of Federal, State, and local clients engaged in ambient water quality and biological monitoring activities of all kinds. Modernized STORET meets the following five requirements set by EPA:

- It must be easy to enter and retrieve data, and the system must be web enabled.
- The system must have menu access and browse capability.

- The system must support the storage of quality assurance and quality control information on a project and result basis.
- The system must be flexible and able to change with the changing needs of its users.
- The system must provide a wide range of standard output forms, including Geographic Information System environments.

STORET centrally stores all data submitted by all agencies, and it allows each State or agency to enter, store, and use its own data. It is a flexible and generalized data warehouse, both within-agency and nationwide, and as such does not have program-specific analysis capabilities built in.

## **2. EDAS**

EDAS is EPA's biological metric calculation software. It is entirely compatible with STORET, and final data should reside in STORET. EDAS contains built-in data reduction and recalculation queries that are used in biological assessment. It is designed to enable the user to easily manage, aggregate, integrate, and analyze data to make informed decisions regarding the condition of a water resource. Biological assessment and monitoring programs require aggregation of raw biological data (lists and enumeration of taxa in a sample) into informative indicators. EDAS is designed to facilitate data analysis, particularly the calculation of biological metrics and indexes. Predesigned queries that calculate a wide selection of biological metrics are included with EDAS.

## CHAPTER 5

- A. Introduction
- B. Nutrient Variables
- C. Biological Variables

# Candidate Variables for Criteria Setting

### A. Introduction

This chapter provides an overview of several trophic state variables that could be used to establish regional and water-body-specific nutrient criteria for lakes and reservoirs. Trophic state variables are those variables that can be used to predict the trophic state of a water body. Trophic state variables include measures of nutrient concentration (e.g., TP, soluble reactive phosphorus, TN, total Kjeldahl nitrogen), plant (macrophyte or algal) biomass (e.g., organic carbon, chlorophyll *a*, Secchi depth), and watershed attributes (e.g., land use). All could be used for establishing criteria to address eutrophication concerns, but only a few are viable candidates for early warning variables. Based on the Proceedings of the National Nutrient Assessment Workshop (U.S. EPA, 1996), the most likely trophic state candidates are TP, TN, chlorophyll, Secchi transparency, and dissolved oxygen. In addition, one watershed metric—land use and the associated phosphorus loading—was recommended as an early warning variable. These variables (metrics or indicators) are briefly reviewed below. EPA presently requires only TP, TN, chlorophyll *a*, and Secchi depth be used, but this set of criteria variables may be augmented by other measurements if the State or Tribe prefers.

Emphasis should be on the open water portion of the ecosystem, and as can be seen in Table 5.1, most of the commonly used biological variables are measures of the amount of organic material in the open water. As discussed later, only a few attempts have been made to incorporate the littoral zone into the assessment of trophic state.

### B. Nutrient Variables

#### 1. Phosphorus

Phosphorus and nitrogen are essential nutrients necessary for the growth of plants in lakes. Of these two nutrients, phosphorus is most often considered to be the nutrient that regulates the production of algae in lakes and is most amenable to control. As such, it is often the variable of concern in regards to lake and reservoir eutrophication. Together with algal chlorophyll *a* and Secchi disk transparency, phosphorus is routinely used to estimate trophic status of lakes and reservoirs (see Chapter 2). Vollenweider (1968) and Sawyer (1947) categorized trophic status according to phosphorus concentration. Lakes with phosphorus concentrations below 10 µg/L were classified as oligotrophic; phosphorus concentrations between 10 and 20 µg/L were indicative of mesotrophic lakes; and eutrophic lakes had phosphorus concentrations exceeding 20 µg/L.

Several forms of phosphorus can be measured. Total phosphorus (TP) is a measure of all forms of phosphorus, dissolved or particulate, that are found in a sample. TP has been used throughout North America as a basis for setting trophic state criteria and in developing related models (NALMS, 1992).

**Table 5.1. Variables Used to Estimate Trophic State in Lakes**

<b>Eutrophication-Related Variables</b>	<b>Apparent Measure</b>	<b>Interference</b>
Total phosphorus	Nutrient concentration, Biomass	Nonbiological, nonalgal forms
Total nitrogen	Nutrient concentration, Biomass	Nonbiological, nonalgal forms
Total organic carbon	Biomass	Nonalgal suspended particulates, dissolved organics
Chlorophyll pigments	Algal biomass, Photosynthetic capacity	Highly variable relationship between chlorophyll and algal carbon or biovolume
Suspended solids	Suspended biomass	Nonalgal particulates
Transparency	Suspended algal biomass	Nonalgal particulates, dissolved color
Turbidity	Suspended algal biomass	Nonalgal particulates
Direct algal counts/ Biovolume	Algal biomass	None, but difficult to do
Biochemical oxygen demand (BOD)	Algal biomass	Nonalgal particulate and dissolved carbon

TP concentrations in runoff or areal exports can be readily related to watershed land use as well (e.g., Reckhow and Simpson, 1980; Walker, 1985a), which makes it an excellent variable for addressing point and nonpoint source loads from the watershed.

Soluble reactive phosphorus (SRP) is a measure of the filterable (filter passings, soluble, inorganic) fraction of phosphorus that is generally thought to be the form directly taken up by plant cells. For this reason, SRP is usually in very low concentrations in lake water, unless phosphorus is not limiting to algal growth. Therefore, it serves more of an indicator of phosphorus limitation than of the trophic status of a lake. For a more complete discussion of the phosphorus forms and their biological significance, see Carlson and Simpson (1996).

TP concentrations vary regionally, as demonstrated by the phosphorus mapping of Omernik (Omernik et al., 1988) and the nutrient ecoregion map in this manual (Chapter 1, Figure 1.3). For example, Minnesota TP concentrations vary substantially between the four ecoregions that contain 98 percent of the State's lakes (Heiskary and Wilson, 1989). Data from Minnesota's ecoregion reference lakes (representative, minimally impacted lakes) demonstrate the variability between and within ecoregions (Table 5.2). The within-region variability can be accounted for in part by the depth of the lakes and mixing status. Table 5.2 reveals the distinct within-region differences in TP as related to lake mixing status. These differences are most pronounced in the north central hardwoods forest lakes where median summer-mean TP concentrations in class I dimictic lakes (mixed only in spring and fall) was 39 µg/L as compared with 89 µg/L for lakes that are continuously mixed (class 3 dimictic or polymictic) lakes. It is likely that internal recycling of phosphorus becomes a significant portion of the phosphorus budget in the shallow eutrophic to hypereutrophic lakes in this ecoregion. Differences are quite



**Table 5.2. Median Total Phosphorus ( $\mu\text{g/L}$ ) Concentrations as Affected by Mixing Status and Ecoregion in Minnesota**

Ecoregion	Mixing Status		
	Class I Dimictic (mixes only in spring and fall)	Intermittently Mixed	Continuously Mixed
Northern lakes and forests	20	26	29
North central hardwood forest	39	62	89
Western corn belt plains	69	135	141
Number of lakes evaluated	257	87	199

Source: Heiskary and Wilson, 1988.

pronounced in the western corn belt plains ecoregion as well, but the population of class I dimictic lakes (based on available data) is quite small.

### ■ Analysis

Phosphorus is relatively easy to measure using a colorimetric procedure (APHA, 1998). To use the procedure, all forms of phosphorus must be converted into orthophosphorus. SRP is a form that is defined as filterable and reactive with the molybdate reagent and generally reflects the amount of orthophosphorus plus some polyphosphates in the sample. Acid-washed sample containers and analytical glassware are essential to avoid incidental phosphorus contamination of the analysis.

The distinction between “particulate” and “dissolved” is primarily a function of the filter used. Traditionally, a  $0.45\mu$  pore size membrane or GF/F glass fiber filter is used (APHA, 1998). Glass fiber filters are used in some noncritical studies, and micropore filters are used in critical studies. The particulate form of TP is converted to the ortho form with an acid hydrolysis step. The strength and nature of the acid can affect the amount of phosphorus converted. Usually, acid potassium persulfate is used for the digestion (APHA, 1998; Ameen et al., 1993; Ebina et al., 1983; Smart et al., 1981; Menzel and Carwin, 1965).

## 2. Nitrogen

Nitrogen is also an essential nutrient for algal growth. In contrast to phosphorus, control of nitrogen sources is more difficult because nitrogen can be assimilated directly from the atmosphere by several types of organisms, including some species of the *Cyanophyta*, the blue-green algae. In addition, nitrogen is not as often limiting to plant growth, thus the focus on phosphorus in the majority of eutrophication-related efforts worldwide.

There are several forms of nitrogen to consider, and its cycling is complex compared with phosphorus. The most common forms of concern in eutrophication evaluation are nitrite, nitrate, ammonia, and organic nitrogen, as measured as total Kjeldahl nitrogen (TKN). Total nitrogen (TN) is considered to be the sum of ammonia, nitrate, nitrite, and TKN. Typically nitrate, nitrite, and ammonia are at very low levels in lakes or reservoirs unless there are some relatively recent loadings of manure or fertilizer present in runoff from the watershed or if nitrogen is not limiting to algal growth. These forms are rapidly used by algae and aquatic plants or converted to other forms of nitrogen. The most useful measurement from a modeling standpoint is either TN or TKN. As with TP, TN concentrations vary regionally. Based on data from Minnesota, TN concentrations in the shallow agricultural lakes are about twofold higher than concentrations in the deeper lakes in the forested region.

TN:TP ratios have been used as a basis for estimating which nutrient limits algal growth (e.g., Smith, 1982). Low TN:TP ratios (less than about 7:1) are indicative of nitrogen limitation, whereas ratios greater than 10:1 are increasingly indicative of phosphorus limitation. Based on data from Minnesota, low ratios occur in some shallow hypereutrophic lakes in the northern glaciated plains. However, these low ratios are typically the result of very high TP loads from point or nonpoint sources in the watershed rather than a shortage of nitrogen. Low TN:TP ratios also are found in lakes receiving significant amounts of sewage effluent.

#### ■ Analysis

Like phosphorus, nitrogen is divided into dissolved and particulate forms based on whether or not a particle passes through a filter. It would be advisable to use the same size filter for both phosphorus and nitrogen. TN is similar in concept to TP, being the estimate of all nitrogen forms. Traditionally, TN is calculated as the sum of the analyses of all nitrogen forms ( $\text{NO}_3^- + \text{NO}_2^- + \text{TKN}$ ). Newer tests allow the conversion of all forms to  $\text{NO}_3^-$  and are therefore direct equivalents to the TP test except alkaline persulfate digestion is used (APHA, 1998; Solorzane and Sharp, 1980; D'Elia et al., 1977).

### C. Biological Variables

#### 1. Organic Carbon

The term “biomass,” used so frequently in the ecological literature, refers to the weight of living material in a unit of measure (in a bacterium, in a cubic meter of water, or in an ecosystem). The bulk of that weight is in the form of organic carbon. Organic carbon production or productivity (the rate at which carbon is fixed in the aquatic ecosystem) has been the basis for numerous trophic state classification systems and for the definition of trophic state itself (Rodhe, 1969). The rates of production and decomposition of carbon compounds and the resulting biomass are at the heart of the eutrophication problem.

Despite the central character of carbon in eutrophication and ecosystem structure and function, carbon has not been explicitly measured or modeled in most standard eutrophication or nutrient/food chain frameworks. This omission may have been, in large part, the result of the difficulty in measuring and interpreting organic carbon. Carbon analysis requires expensive, dedicated equipment, and each type of instrument produces slightly but significantly different estimates of carbon. Although the criticism of technique-specific results can probably be invoked for all of the variables discussed in this chapter, the expense of the equipment plus the variety of techniques available may have restricted the popularity of the routine analysis of carbon.

A second reason for the limited use of carbon in eutrophication-related studies is that chlorophyll pigments or direct measures of algae and macrophytes not only estimate plant biomass, but also directly indicate the photosynthetic capacity to produce carbon. Chlorophyll also remains the only economic means to directly measure algal biomass free from significant interferences. However, the chlorophyll-to-carbon ratio in phytoplankton varies by about a factor of 5 depending on ambient light and nutrient levels (Laws and Chalup, 1990). Consequently, measuring particulate organic carbon together with chlorophyll could better assess the amount of autochthonous carbon, particularly during bloom conditions.

There are several reasons for measuring organic carbon. Organic carbon now can be measured more easily and precisely than in the past. The use of carbon associated with algal metabolism and decomposition greatly facilitates the modeling of dissolved oxygen. Because many shallower stratified systems experience hypolimnetic anoxia, models incorporating the carbon factor must be capable of accurately simulating this phenomenon. The direct modeling of organic carbon becomes especially important for systems where both allochthonous and autochthonous carbon sources are important. The use of eutrophication models as the basis for examining the transport and fate of toxic substances in lakes and impoundments requires that the amount and forms of organic carbon be specified. Such confounding problems include toxic organics, metals, and disinfection byproducts. Finally, the state of the lake's bottom sediments is inextricably tied to the amount of carbon it receives from the overlying waters. This has ramifications for sediment oxygen and toxic substance sequestering.

## **2. Chlorophyll *a***

Chlorophyll is the major photosynthetic pigment in plants, both algae and macrophytes. As such, it is the important variable when any estimate of the photosynthetic capacity of an ecosystem is desired. Chlorophyll is probably most often used as an estimator of algal biomass. The relationship between chlorophyll and TP is well established for lakes and reservoirs across much of the world. Despite the curious fact that the chlorophyll molecule itself contains no phosphorus while TP includes phosphorus dissolved in the water as well as in algal cells, relationships between TP and chlorophyll have dominated the empirical linkages between nutrients and the biological response of the algae in lakes. See Nurnberg (1996) for a recent review of these relationships.

Chlorophyll is also a preferred variable because there are lakes where TP is not the sole or primary limiter of algal production or biomass, for example, lakes with high inorganic turbidity or high flushing rates. For instance, a chlorophyll *a* goal of less than 30 µg/L was used for Lake Pepin, a run-of-the-river reservoir on the Mississippi River between Minnesota and Wisconsin (Heiskary and Walker, 1995). In this reservoir, inorganic turbidity and high flushing rates were the primary factors controlling algal production during above-average flows (about 20,000 cfs or greater), and chlorophyll *a* routinely remained below 30 µg/L at these flows. In contrast, as flows declined below about 20,000 cfs and residence time increased above 10 to 14 days, chlorophyll *a* increased as the influence of residence time and inorganic turbidity declined, and the potential trophic status, as reflected by TP, was realized.

Because of the relationship between chlorophyll and phosphorus and its linkage to algae biomass, chlorophyll is often a major component of trophic state indices (Carlson, 1977) and water quality criteria. Oregon has set an endpoint of 10 µg/L for natural lakes that thermally stratify and 15 µg/L for natural lakes that do not thermally stratify (NALMS, 1992). Similarly, North Carolina uses a standard of 40 µg/L for warm waters and 15 µg/L for cold waters (NALMS, 1992). On the regional level, Raschke (1994) proposed a mean growing season limit of 15 µg/L for water supply impoundments in the

southeastern United States and a value of 25 µg/L for water bodies primarily used for other purposes (e.g., viewing pleasure, safe swimming, fishing, boating).

In addition to the use of chlorophyll in classification, the chlorophyll interval frequency (bloom frequency) can be predicted based on regression equations developed by Walker (1985b) relating blooms to phosphorus. These chlorophyll *a* intervals can be related to varying user perceptions of lake condition. The projected frequency of these extreme events, as a result of increased phosphorus loading can be readily understood by citizens and decisionmakers (Heiskary and Walker, 1988).

## ■ Analysis

The term “chlorophyll” really represents a family of molecules, chlorophyll *a*, *b*, *c*, and *d*. Chlorophyll *a*, because of its primary role in photosynthesis, is often the molecule of preference. Chlorophyll can be measured by several different methods. Most include steps of concentration of the algae, extraction of the chlorophyll with a solvent, and measurement of the chlorophyll molecule. Unfortunately, each of these techniques and choices of solvents, extraction times, and methods for measuring the chlorophyll can produce widely different estimates of chlorophyll.

Chlorophyll *a* is the primary photosynthetic pigment and can be measured quite accurately with high-performance liquid chromatography (HPLC) analysis. The use of colorimetric techniques to measure chlorophyll *a* free from all forms of interference from either decomposition products (phaeophytin, phaeophorbides, or chlorophyllides) or other chlorophylls (chlorophylls *b* and *c*) is almost impossible. However, if the purpose of measuring chlorophyll is to estimate biomass rather than to know the absolute amount of photosynthetic pigment, the absolute accuracy obtained by HPLC is not necessary and the spectrophotometric techniques suffice. Most published relationships between TP and chlorophyll were made using these cruder spectrophotometric methods.

Because chlorophyll *a* cannot be measured without interference, Carlson and Simpson (1996) recommend using total chlorophyll pigments (the estimated chlorophyll at a single wavelength) rather than subjecting the sample to further manipulations to obtain an estimate of chlorophyll *a*. However, the acidification step recommended in the Standard Methods (APHA, 1998) does remove some phaeophyton interferences, and the resultant chlorophyll concentration measured may be closer to the actual concentration than an unacidified measure. Fluorometry also can be used, especially if algal densities are very low and a very sensitive method of detection is needed.

Chlorophyll pigments degrade easily. Whole nonfiltered samples can apparently be kept for several days if left in the dark and in the refrigerator. Filtered samples should be kept dark and frozen. Filtered samples immersed in the solvent are apparently stable as long as they are kept dark. More information on chlorophyll preservation can be obtained from Carlson and Simpson (1996) and the American Public Health Association (1998).

The important consideration for any of these techniques is that standardization of methodology is critical. Alteration of the extraction solvent, extraction time, type of filter used to concentrate the sample, or concentration of acid used to convert chlorophyll into phaeophytin all can alter the concentration estimates. Therefore, once a technique is chosen, for the sake of data consistency, the technique should be altered only with the knowledge that some of the previously collected data may not be compatible. This is one reason for using total chlorophyll; it requires the least analytical manipulation and therefore is the most conservative estimator of chlorophyll. Caution also should be used when obtaining data from several sources that use different techniques that may produce discrepancies. This is

particularly important when compiling several data sets to establish reference conditions for criteria development.

### **3. Secchi Disk Transparency**

Secchi disk transparency, or Secchi depth, can cheaply provide a great deal of information on lake water quality and, together with TP and chlorophyll *a*, has become routinely used as a measure of lake trophic status (e.g., Carlson, 1977). Secchi depth is routinely incorporated into citizen volunteer monitoring programs, and in many States, it often provides the best basis for identifying trends in trophic status over time (Heiskary et al., 1994). Smeltzer et al. (1989) found Secchi transparency to be the best variable for identifying statistically significant trends in trophic status because of the large number of observations that can be gathered in a given season and the ability to gather numerous years of data at little or no cost as compared with TP and chlorophyll *a*, which are typically monitored at a much reduced frequency and at a higher cost. As with other variables, Secchi depth may vary considerably in a given lake between and within seasons; therefore, it is desirable to have an “indicator season.” In many States, the most reliable timeframe for measuring Secchi transparency and estimating lake trophic status is summer, typically mid-June to mid-September. Thus, this is the focus for much of the citizen and professional data gathering that takes place. Summer-mean measures of TP, chlorophyll *a*, and Secchi depth then are used to estimate lake trophic status. It should be noted that Secchi depth measurements are inadequate for nutrient level estimations in lakes with colored water or inorganic suspended solids. In such instances, the TN and TP measurements are more telling indicators of enrichment.

User perception measurements may be taken in conjunction with Secchi readings. These user perceptions, especially when recorded by citizen volunteer monitors, can provide a good basis for associating designated uses and subjective perceptions of water quality with actual measurements of water quality. Citizen volunteer programs in Minnesota, Vermont, and New York routinely collect this information. Smeltzer and Heiskary (1990) found that user perceptions may vary between States and may vary further between regions within a given State. This type of information can provide a perspective useful for criteria and goal setting purposes (see Vermont and Minnesota case studies in Appendix B).

#### **■ Analysis**

The standard Secchi disk used in limnological investigations is a 20 cm diameter disk that either is all white or has alternating black and white quadrants. Techniques vary as to how the depth should be measured, and statistically significant differences between the techniques have been reported. Probably the best method is to lower the disk on the sunlight side of the boat to eliminate shading the disk or to have the disk disappear in a background darkened by the shadow of the boat. Glare on the water is eliminated by using a viewscope to view the disk. The disk is lowered until it cannot be seen, the depth is noted, and then the disk is raised until it can be seen again. The average between the depth of disappearance and the depth of appearance is called the Secchi depth.

Considerable variations of this technique exist. Probably more programs lower the disk on the shady side of the boat and do not use a viewscope. The use of a viewscope or the side of lowering will give different results. The choice of an all-white or a black-and-white disk also will give different readings, especially in clearer waters. The point to be emphasized is that the particular method chosen may not be as important as consistency in the method of Secchi depth determination. Data consistency almost dictates that the technique cannot be changed without transforming part of the data record or losing

historical information. When consistently applied in conjunction with TP and TN calibrations, Secchi depth change is a helpful tool for blue-green algal bloom prediction in north temperate lakes.

#### **4. Dissolved Oxygen**

Dissolved oxygen (DO) and temperature profiles are routinely taken in eutrophication-related studies. These measurements are essential for characterizing the mixing status and for determining the presence or absence of oxygen above the sediments, the rate of hypolimnetic oxygen depletion, the number of days of anoxia, and whether the lake has suitable habitat for sensitive fish species. Anoxic conditions in lakes also may favor the growth of blue-green algae such as *Microcystis* (Reynolds and Walsby, 1975). The lack of oxygen in the bottom waters causes sediments to release such dissolved constituents as inorganic phosphorus, ammonia, and hydrogen sulfide. The initial disappearance of oxygen in the hypolimnion can occur before any noticeable change in the productivity of algae in the epilimnion because of the amplification of organic epilimnetic inputs by the sediments (Gliwicz and Kowalczewski, 1981). This makes the oxygen content of the hypolimnion and the rate of disappearance to be a potential early warning system of changes in trophic state.

Oxygen concentrations and rates of depletion have been used to characterize lakes and can in some instances be related back to nutrient status. In contrast to the previous variables where epilimnetic or composite measurements were key, the focus for DO in lakes is primarily on hypolimnetic concentrations. DO concentrations in the hypolimnion can be related to epilimnetic TP and annual primary production and inversely to mean summer Secchi depth (Cornett and Rigler, 1979). Checking for the presence or absence of hypolimnetic oxygen was an early method of discriminating between oligotrophic and eutrophic lakes (Thienemann, 1921) that is still used to some extent today. Hypolimnetic oxygen depletion rates have been used as a variable of trophic state by several investigators (Mortimer, 1941; Rast et al., 1983). This would not apply to allochthonous organic loading, which may deplete DO independent of nutrient concentrations.

Because the presence or absence of hypolimnetic oxygen and oxygen depletion rates are confounded by the size of the hypolimnion, the rate usually is indexed to the area of the hypolimnetic surface and termed the areal hypolimnetic oxygen deficit (AHOD) (see Hutchinson, 1957; Wetzel, 1975). Compensating for the size of the hypolimnion will not necessarily give a value correlated with the amount of productivity or nutrient status of the epilimnion because the rate of oxygen consumption is dependent on temperature as well. Latitudinal differences in AHOD will exist independent of the trophic status (biomass concentration) of the lake. The hypolimnetic oxygen depletion rate is also affected by dissolved color; Hutchinson (1957) recommends that AHOD not be used on lakes with color greater than 10 Pt units.

Walker (1979) used trophic status, AHOD, mean hypolimnion depth, and oxygen concentration at spring turnover to predict the effective number of days of oxygen supply present in the hypolimnion after spring turnover. Nurnberg (1996) quantified hypolimnetic anoxia based on DO profiles and lake morphometry and related this anoxic factor to other trophic status variables. Thus, DO is an important variable to consider when assessing the impact of eutrophication, even though it does not define trophic state.

#### **■ Analysis**

Measurements are typically taken at appropriate intervals from the surface to the bottom of the lake on each sample date. Oxygen is typically taken using a remote sensing probe, although oxygen also can

be measured by analyzing individual samples using the Azide Modification of the Winkler technique (APHA, 1995). The minimum frequency for characterizing mixing and oxygen status of the lake is dependent on the rate at which oxygen can be depleted in the water body, which itself is dependent on the size and temperature of the hypolimnion and the potential amount of organic matter that may be settling into this region. In some cases, the minimum frequency may be a month; in others, it may only be a few hours. Some shallow lakes experience daily oxygen depletion near the bottom.

## 5. *Macrophytes*

The term “macrophyte” refers to any plant life larger than the microscopic algae in aquatic systems. It may be a plant rooted in the sediment, such as pond weeds or cattails, or that is free-floating, such as duckweed or coontail. It also includes large algae such as *Chara*. Macrophytes are important in any consideration of trophic state because they are also plants and, therefore, are potential utilizers of incoming plant nutrients. Although a great deal of research has been done on macrophytes, the ability to predict the extent of macrophytes based on nutrient load or even nutrient concentration still has not been attained.

Although macrophytes require nutrients for growth, the immediate origin of those nutrients is still a matter of some controversy. Originally it was thought that macrophytes may compete with algae for nutrients in the water; this may be the case for floating species, such as duckweed or coontail. Evidence suggests that rooted aquatic plants draw most, if not all, of their nutrients from the sediments, not from the water. In this manner, they can obtain nutrients from the sedimented historical phosphorus. This use of historical nutrients obscures or even eliminates correlations and predictions of macrophyte biomass based on contemporary nutrient loading. It also discourages the management of macrophyte-based eutrophication by nutrient loading control because the macrophytes may persist and most likely even spread after nutrient reduction.

Despite the lack of correlation between macrophyte biomass and nutrient loading, they still may be related. Nutrients attached to particles will settle out, bringing new substrate and nutrients to the macrophytes. Dead algae will also settle, again increasing substrate and nutrients. The presence of macrophytes near water inputs may actually serve to intercept sediment particles, thus building up these regions faster than if the particles were allowed to sediment throughout the lake. Increased nutrient loading can be expected to enhance the sedimentation rate and thus increase the areal coverage of macrophytes (Carpenter and Lodge, 1986). The macrophytes may actually serve as a positive feedback mechanism that enhances the filling in of lakes, their own structures serving to fill in the littoral area and increasing the colonizable area even more.

Considerable evidence suggests that some sort of antagonism exists between macrophytes and floating algae in lakes and ponds. Macrophyte density may be suppressed when algal densities are high, presumably because the algae and/or epiphytes on plant surfaces shade out macrophytes. Conversely, if macrophytes are dense, there are accounts of the algae not growing, even in the open areas outside the macrophyte beds. It has been hypothesized that a chemical is excreted by the macrophyte that suppresses algal growth. According to the most sweeping theory relating eutrophication to the relationship between algae and macrophytes, as a lake eutrophies it may become dominated by either algae or macrophytes, but not both (Scheffer, 1989; Scheffer et al., 1993). Catastrophic events, such as herbiciding or weed harvesting, can shift a macrophyte-based system entirely into an algal-based system. Alternatively, killing the algae by algicides or by nutrient reduction will shift the system into a macrophyte-dominated system with little algae present. Both of these systems are stable and will persist unless again shifted by external events. If this model is correct, assessment and prediction of the response to nutrient loading

increases or reductions will be difficult unless the mechanism underlying these alternate states is known. However, the ability to manipulate the system as Scheffer (1989) has suggested allows the selection of the most desirable type of condition, algae or macrophytes, for a given use and enrichment level.

Most trophic state variables and, indeed, all simple nutrient loading models ignore the growth and extent of macrophytes, probably reflecting the early limnological emphasis on open-water algae. This neglect of the macrophytes hinders the determination of the impact of nutrients on the entire biological system. If nutrient loading models or trophic state variables do not account for macrophyte biomass, they may underestimate the potential impact of nutrients in macrophyte-dominated lakes.

### ■ Analysis

The solution for macrophyte biomass determination could be very simple. Canfield et al. (1983) proposed the assessment of trophic state based on the TP concentration of the lake, including the amount of phosphorus in macrophytes in the lake. The total macrophyte biomass in the lake (kg) is estimated by the equation:

$$\text{TSMB} = \text{SA} \times \text{C} \times \text{B}$$

where TSMB = total submersed macrophyte biomass, SA = lake surface area, C = percent cover of submersed aquatic macrophytes, and B = average biomass collected with a sampler.

Canfield et al. (1983) estimated the TP in plant biomass based on the phosphorus in each species and the relative abundance of each species. The TP content of the lake was obtained by adding the amount of phosphorus in the macrophytes to the amount estimated to be in the water column. There seems to be no reason why the same approach could not be used to measure total plant biomass or chlorophyll. Trophic state could then properly include both macrophytes and algae and would have internally consistent units. This would be an instantaneous measure, as sediment phosphorus availability to the biota is assumed to be measured in the macrophytes and algae.

## 6. *Biological Community Structure*

Some early trophic classifications were based on the biota of lakes. Thienemann (1921) simultaneously developed a classification scheme based on the species of benthic chironomids in lakes and on the hypolimnetic oxygen concentration that affected their species composition. It must have seemed reasonable at the time that the classifications of Thienemann (1921) and Naumann (1929) could be joined, because Naumann's eutrophic lakes also lacked oxygen in the hypolimnion and had distinct benthic fauna (Thienemann, 1921).

Because of Thienemann, the benthos of lakes has received a great deal of attention in trophic classification. The array of Chironomids, clams, and oligochaete worms have been shown to change with trophic state. In most cases, these changes are related to the loss of oxygen in the hypolimnion. Algal species change as a lake becomes more eutrophic, with a dominance of diatoms shifting to cyanobacteria (blue-green algae). Certain species of diatoms are characterized as being found largely in oligotrophic lakes while others are found in eutrophic situations. Because the frustules of diatoms are preserved in the sediment, this change in species allows a paleolimnological investigation of past trophic states. Zooplankton species change as well, but their change is confounded by alterations in the intensity of



predation upon them as the density of zooplanktivorous fish increases, perhaps the result of alterations in the density of the macrophytes that give the fish shelter from their predators.

In general, fish yield increases as the productivity of the lake increases. However, there may be changes in the dominant fish species as a lake eutrophies (Oglesby et al., 1987) (Figure 5.1). In northern lakes, salmonids may dominate in clear lakes having oxygenated hypolimnia. When primary productivity increases to the point that the hypolimnion becomes anoxic, salmonids may disappear to be replaced by percids; percids then are replaced by centrarchids; and finally, at the highest nutrient concentrations, rough fish such as carp or bullheads prevail.

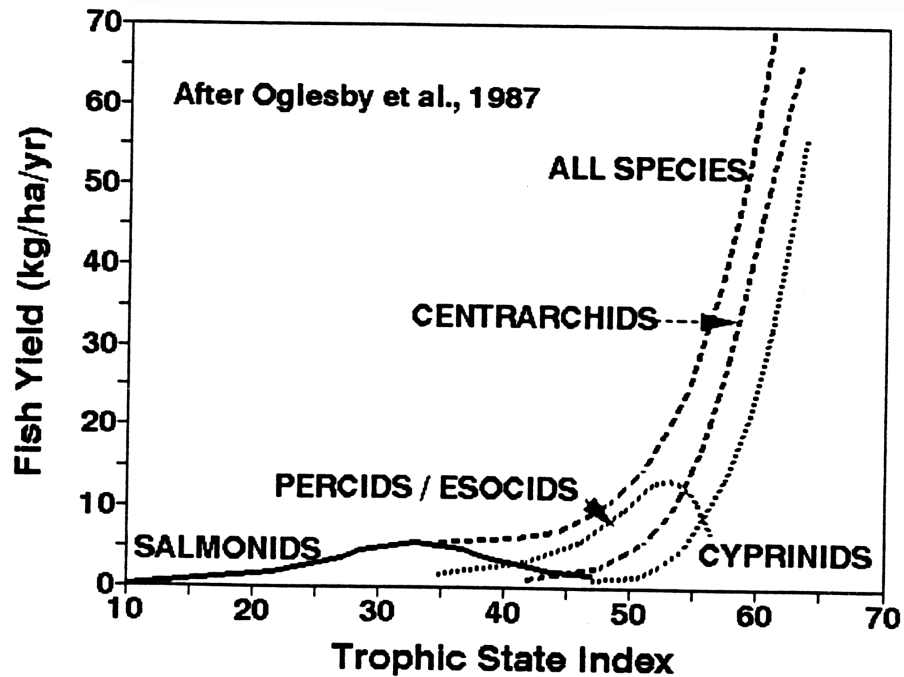

Figure 5.1. Changes in fish species yield with trophic state.

## ■ Analysis

Unfortunately, changes in biological structure do not fit neatly into a nutrient-based classification because structural changes can occur along any environmental axis such as pH or temperature. The bioassessment of aquatic habitats has its strength in the concept that the organisms can be sensitive variables of the condition of the aquatic environment. However, unless a great deal is known about the requirements of the organisms themselves, the assessment does not necessarily indicate the nature of the disturbance. Such general variables would be of little use as variables of nutrient change if they were susceptible to change by a large number of other factors as well.

The fact that the assessment of the species or species complexes in a lake may not be the sole indicator of nutrient-related changes does not mean that assessing and tracking the biological structure would not be useful. It could be that subtle changes brought about by nutrient enrichment may affect one or more groups, and these changes may be more apparent in the structure than in the biomass.

## D. Land Use

Changes in land use in a lake's watershed is a viable early warning indicator of potential lake eutrophication. Landscape data can be used to characterize the watersheds of a population of lakes and to estimate potential nutrient loadings under a variety of management scenarios. For example, the State of Maine seeks to protect lake water quality by limiting the acceptable increase in phosphorus in their lakes that may result from changes in land use in the watershed. Very strict requirements for handling storm water are a primary aspect of their approach (see Maine case study in Appendix B). The changes in land use of most concern are typically the shift from forested or open uses to agricultural or urban land uses. Phosphorus exports and concentrations associated with various land uses are fairly well documented in the literature (e.g., Reckhow and Simpson, 1980) as well as the effects of the increased loading on lakes. Thus, increases in phosphorus loading as related to changes in land use can be estimated, and the impact of the changes can be described by means of empirical models. Whenever possible, it is advisable to use phosphorus concentration and export data summarized based on watersheds in a State or region because phosphorus export may vary between regions as well as between land use types. Some general notes and examples follow.

The generalized land use categories often considered for modeling or prediction purposes are forest, water and marsh, cultivated, pasture/open, and developed (urban and residential). While phosphorus exports and concentrations from a given land use may vary substantially in the literature, some general patterns emerge. The average phosphorus concentrations found by Omernik (Rohm et al., 1995) give some indication of the radical changes in concentration alone when land is disturbed. If the changes in water loading caused by increased impervious surfaces and decreased plant transpiration are included, the potential impact of human activity in the watershed can be easily seen.

Phosphorus exports from forested lands are typically low, on the order of 0.1 to 0.15 kg phosphorus/ha/yr (Reckhow and Simpson, 1980; Verry and Timmons, 1982). Based on data from the predominantly forested Northern Lakes and Forest ecoregion of Minnesota (Table 5.2), stream TP concentrations typically range from 20 to 50  $\mu\text{g/L}$  (McCollor and Heiskary, 1993) (Table 5.3). This range of exports and concentrations is often applicable for marsh land use as well, although phosphorus export will vary seasonally in marshes.

Pastured and open land use is a somewhat nebulous category that might include idle grasslands (e.g., Conservation Reserve Program, [CRP]), park lands, or heavily pastured lands. Feedlots should not be

included in this category but rather should be considered separately with estimates made on a per animal unit basis. Pastured and open park land exports often range from about 0.2 to 0.4 kg phosphorus/ha/yr. For example, two monitored subwatersheds in southwest Minnesota, with 60 percent or more of the watershed in CRP, had phosphorus exports of 0.25 to 0.40 kg phosphorus/ha/yr (Schueler, 1995).

Phosphorus export from cultivated lands is frequently high and variable. Reckhow and Simpson (1980) note that phosphorus export might vary between mixed agriculture (0.4 to 2.3 kg phosphorus/ha/yr) and row crops (0.2 to 0.9 kg phosphorus/ha/yr). Phosphorus exports from two southwest Minnesota watersheds characterized by 81 percent and 49 percent cultivated land use were 0.4 and 0.6 kg phosphorus/ha/yr, respectively. Phosphorus concentrations from streams in the highly agricultural western corn belt plains ecoregion of Minnesota typically range from 160 to 330 µg/L (Table 5.3). Prairie and Kalff (1986) suggest however that phosphorus export from agricultural land varies as a function of watershed size, and they present equations for calculation of phosphorus export by land use type and watershed size. In general, as watershed size increases, phosphorus export tends to decrease in agricultural lands, with row crops and pasture exhibiting the greatest decrease. In practice, this often leads to phosphorus export coefficients on the order of 0.2 to 0.6 kg phosphorus/ha/yr for cultivated lands. This was not the case in forested watersheds, where little change, as a function of watershed size, was noted.

Urban land uses tend to export phosphorus at rates often equivalent to or higher than some cultivated land uses. The extent of impervious surfaces is a primary reason for higher export rates. These impervious surfaces are very efficient conduits for exporting water and contaminants off the landscape.

**Table 5.3. Interquartile Range of Phosphorus Concentrations (µg/L) for Minimally Impacted Streams in Minnesota by Ecoregion, 1970-1992**

Ecoregion	Percentile		
	25%	50%	75%
Northern lakes and forests	20	40	50
Northern Minnesota wetlands	40	60	90
North central hardwood forest	60	90	150
Northern glaciated plains	90	160	250
Red River valley	110	190	300
Western corn belt plains	160	240	330

Source: McCollor and Heiskary, 1993.

Thus, high phosphorus exports from urban land uses might be more a function of efficiency of delivery rather than land use per se. Reckhow and Simpson (1980) suggest a range of 0.5 to 1.25 kg phosphorus/ha/yr for urban land uses. Walker (1985a) estimated urban phosphorus export of 0.5 kg phosphorus/ha/yr for low-density residential use in Minnesota and 1.2 kg phosphorus/ha/yr for mixed urban and commercial use. The higher range of phosphorus exports might be appropriate where storm sewers drain impervious areas without the benefit of intervening sedimentation basins. Bannerman et al. (1993) in a comprehensive study of storm water in Madison, Wisconsin, found TP concentrations, as monitored at specific sites in the city, to range from a low of 150 µg/L from roofs to 2,670 µg/L from lawns. However, in terms of critical-source areas and contaminant-load percentages, streets and driveways, where runoff volumes were high, accounted for 78 percent of the overall TP loading from the residential land use area, while lawns, where runoff volumes were low, accounted for 14 percent in their study.

■ **Analysis**

The availability of land use data may vary between locales. However, with the increasing use of Geographic Information System (GIS) databases, this aspect of lake and watershed assessment should become easier in the future. In general, the first step is to delineate the total watershed of the lake. It may be worthwhile to also delineate the immediate watershed (that portion which drains directly to the lake without going through another lake or major wetland) because land use changes in that portion of the watershed may ultimately have the greatest impact on the lake of concern. Once the watershed is delineated, land use information might be acquired from GIS data, aerial photos, and/or other records that might be available through soil and water conservation districts, local planning and zoning offices, or other sources. Land use categories should be mapped, and summaries in terms of the total area (e.g., hectares) and percent composition of the watershed by land use type should be noted. This information combined with current monitoring data should provide a basis to begin evaluating the effect of future changes in land use on the water quality of a lake. It also may be instructive to have land use data from a representative subset of lake watersheds in a given State or ecoregion for comparison purposes. For example, the land use composition of reference lake watersheds has been evaluated by ecoregion for Minnesota (Table 5.4). This provides a basis for comparing the land use assemblage for the lake under study compared with the typical composition for lakes in the same region. This comparison may, in part, explain deviations in water quality from regional norms or typical values.

**Table 5.4. Typical Watershed Land Use Composition for Minnesota Ecoregion Reference Lakes (based on interquartile range)**

<b>Land Use (%)</b>	<b>Northern Lakes Forests</b>	<b>North Central Hardwood Forests</b>	<b>Western Corn Belt Plains</b>	<b>Northern Glaciated Plains</b>
Forest	54-81	6-25	0-15	0-1
Water and marsh	14-31	14-30	3-26	8-26
Cultivated	<1	22-50	42-75	60-82
Pastured	0-6	11-25	0-7	5-15
Cultivated and pastured	0-7	36-68	48-76	68-90
Developed	0-7	2-9	0-16	0-2

# CHAPTER 6

## Identifying and Characterizing Reference Conditions

- A. Significance of Reference Conditions
- B. Approaches to Establishing Reference Conditions
- C. Initial Data Retrieval and Processing to Support Nutrient Criteria Development

### A. Significance of Reference Conditions

Establishing lake reference conditions for each of the physical lake classes within each ecoregion or subdivision of that region is a critical part of the nutrient criteria development process. Reference conditions for each of these classes are the quantitative descriptions of lake conditions used as a standard for comparison purposes. Ideally, reference conditions associated with nutrient-related variables such as phosphorus, nitrogen, and chlorophyll *a* are concentrations representative of lake conditions in the absence of anthropogenic disturbances and pollution. However, because it can be argued that most, if not all, lakes have been impacted by human activity to some degree, reference conditions realistically represent the least impacted conditions or what is considered to be the most attainable conditions. While the reference conditions themselves are not specifically established as criteria, they help to set the upper bounds of what can be considered the most natural and attainable lake conditions for a specific region. Knowing this “reference best case situation” together with the other four elements of a nutrient criterion allows resource managers to set the criteria at appropriate levels; of course, other relevant factors such as attainment-of-use designation, regional perceptions of water quality, and physical/geological influences need to be considered as well.

### B. Approaches to Establishing Reference Conditions

In accordance with the five elements of nutrient criteria development, there are three general approaches for establishing reference conditions:

- *Direct observation (data collection) of sites and estimation or inference of reference conditions.* This may take two forms: (1) observation of sites that meet reference site requirements and (2) observation (data) of an entire population of lakes. It is assumed that some percentile of either distribution represents a reference condition.
- *Paleolimnological reconstruction of past conditions.* This means inference of reference conditions from observations of nonreference sites. It requires statistical models based on large data sets and a sample of dated sediment cores for the lake classes in question.
- *Model-based prediction or extrapolation of reference conditions from related data sets or related knowledge.* The predictions may come from statistical models (usually regression models), mass balance models, or combinations of the two.

These three approaches are not exclusive, and they require professional judgment and expertise to implement. Regional experts are often the most qualified to make determinations about which lakes in a region most likely represent “ideal” or most desirable conditions. Local expert knowledge of regional

characteristics, human-induced changes over time to regional lake and watershed conditions, patterns of development associated with a lake and its watershed, and current conditions as they relate to perceived impaired or unimpaired status can many times be the most efficient and cost-effective way of identifying candidate reference lakes. This method should be used only when it is clear that adequate professional expertise exists for a region. Experts who may be qualified to participate in the selection process could come from an array of disciplines such as limnology, biology, resource management, engineering, and other related fields.

### ***1. Direct Observation of Reference Lakes***

#### **■ Reference Lake Approach**

Reference lakes must be representative of a region and their conditions (including level of enrichment that may inherently range from oligotrophic to eutrophic or hypereutrophic) should represent the best range of minimally impacted conditions that can be expected of similar lakes within the region. Although lakes that are undisturbed by human activities are ideal as reference sites, land use practices and atmospheric pollution have so altered the landscape and quality of water resources nationally that truly undisturbed lakes are rarely available.

A set of requirements may be established to help define a minimally impacted lake and, therefore, make the selection of reference sites a rule-based procedure. For example, reference lakes could be chosen only from park or preserve areas (i.e., areas that have not been subjected to any type of significant development within a reasonable period of time). If relatively unimpacted conditions do not occur in the region, the selection process may be modified to be more realistic and to reflect the least altered lakes. Such selection can pertain to the condition of the watershed, as well as the lake itself. The following are examples of conditions that can be defined to select reference lakes:

- *Land use.* Natural vegetation has a positive effect on water quality and hydrological response of streams. Reference lakes could be chosen from watersheds that have an established minimum percentage of existing natural vegetation cover, such as 50 percent or more. Alternatively, reference criteria could be defined as less than a certain percentage of urban or residential land use in the watershed.
- *Riparian zones.* Zones of natural vegetation alongside the lakeshore and streams stabilize shorelines from erosion and contribute to the aquatic food source through allochthonous input. They also reduce nonpoint pollution by absorbing and neutralizing nutrients and contaminants. Reference lakes could be chosen from watersheds that contain at least a set minimum area of existing natural riparian zone, regardless of land use outside the riparian buffers. For example, reference lakes could be required to have 65 percent or more of the lakeshore and its immediate tributaries in natural bankside vegetation to a distance of at least 10 m from the shoreline.
- *Best management practices.* Urban, industrial, suburban, and agricultural nonpoint source pollution can be reduced with successful best management practices (BMPs). Watersheds from which reference lakes are chosen could be required to have certain BMPs in place, provided that the efficacy of the BMPs has been demonstrated.

- *Discharges.* Point source discharges from industry and from municipal waste water treatment plants (e.g., National Pollutant Discharge Elimination System, storm water) and known areas of nonpoint source discharges (e.g., from agricultural areas) have the potential to negatively affect water quality of streams, rivers, and lakes. Reference lakes could be chosen from watersheds that have no discharges or that have a defined maximum level of discharges into surface waters.
- *Management.* Management actions, such as controlling water level fluctuations for hydropower or flood control, can significantly influence lake conditions. Reference lakes could be limited to those lakes that are in no way affected or are affected only in a very limited way by such management activities.

Predefined reference conditions for lakes have been used in Minnesota to determine ambient phosphorus criteria (Heiskary, 1989) (see case study at the end of this chapter). Maine uses a similar approach in regulating the water quality of streams (Davies et al., 1993).

### *Characterizing Reference Conditions*

The objective of reference condition characterization is to describe reference lake conditions in terms of the variables that have been chosen to express nutrient conditions. To properly characterize reference conditions, adequate data associated with the reference lakes must be available. If existing data are deemed to be insufficient for characterization purposes (see Chapter 4), then a sufficient number of reference lakes must be sampled to obtain the data necessary for characterization of reference conditions. There is no definitive rule for establishing a minimum number of reference sites appropriate to the development of a reference condition, and the greater number the better. The amount of available data will dictate where each lake is a sampling unit—perhaps a general rule of thumb for reference sample size could be at least 10 percent of the lake class of concern and a minimum of 10 to 30 lakes per region (see Chapter 4 for a discussion of sampling approaches and methodologies). Before sampling begins, candidate variables should be evaluated and target variables selected (see Chapter 5). All sampling and analytical activities should be conducted according to standard protocols to ensure validity.

During sampling visits, the candidate reference lakes should be examined to confirm whether they actually meet the reference site requirements. This may include looking for discharges into the lake or its tributaries and a quick survey of the lake watershed to determine if new modifications may have changed the lake. If a lake appears to have been significantly impacted, measurements should be made for in-lake and lake discharge nutrient concentrations and biological response variables such as chlorophyll concentration and fish, macroinvertebrate, macrophyte, and planktonic community variables. Lakes that do not meet the physical reference requirements should be excluded from the reference data set. However, a high nutrient concentration present in an otherwise minimally developed lake watershed is not justification alone for exclusion. This may be part of the natural background level to be identified by the reference condition process.

#### **Significantly Altered Lakes**

If all lakes in a region are significantly altered, it might not be possible to select appropriate reference sites. In such a case, an alternative would be to use lakes from neighboring regions as reference sites if those lakes are deemed acceptable, by professional judgment, with respect to impact and overall comparability to the lakes of the affected region. If lakes from nearby regions cannot reasonably be considered reference sites, then reference lakes must be identified and reference conditions must be predicted or inferred from other information, including models and historical data. In designing such an approach, the consensus of a panel of regional experts helps ensure an objective and rational design.

Once the desired lake reference data have been obtained, statistical approaches can be used to determine if individual lakes fit the preliminary reference lake classification. The preliminary classification is refined through inspection of plotted data (e.g., using box and whisker plots, scatter plots, or other means of graphical analysis), professional judgment, and statistical tests of final classification hypotheses. Next, the values and distribution of reference metrics are compared among ecoregion or lake type. Regions that appear to be similar to each other can be combined for the final classification. For two regions to be so combined, most of the metric distributions must be similar. Chapter 7 further describes the derivation of criteria from these reference lake data sets. States that share an ecoregion are encouraged to also share data to determine reference conditions.

### ■ Lake Population Distribution Approach

If a fixed definition of reference condition is deemed to be overly restrictive or an impractical ideal, then an empirical working definition is an alternative. For example, because natural conditions for reservoirs cannot be defined, the best existing conditions are used instead. This approach is also useful in ecoregions with little contiguous natural vegetation remaining, such as in the agricultural Midwest. The approach does not involve the identification of reference lakes, but sets reference conditions by using an entire population of lakes from within a region. It is especially relevant for man-made impoundments and reservoirs, where no least-impaired systems exist, as well as for lakes subject to strong and relatively uniform human impacts, such as in large urbanized areas or in heavily agricultural regions.

A representative sample of lakes is taken from the entire regional lake population. Lakes that are known to be severely impaired may be excluded from the sample, if desired. The population distribution of each selected variable is determined, and the best quartile or lower 25th percentile of the distribution of each variable is taken as its reference value. Using the same logic described for Secchi depth, the opposite end of the distribution is used, and the quartile at the high-quality end of this distribution is selected so this reference value is a “reasonable” upper limit (excluding outliers of the population distribution). See Chapter 7 for further discussion.

A central assumption of the frequency distribution approach is that at least some sites in the population of lakes are high-quality lakes, which will be reflected in the values of the individual variables. Because they have no independent definition, reference conditions defined in this way must be taken as preliminary and subject to future reinterpretation, especially as lake management efforts produce improved conditions. Periodic examination of the reference values for trends can detect deterioration or improvement. This is necessary when reference criteria cannot be defined a priori or when all lakes under consideration are equally impaired. The objective of the method is to develop a measurement standard for assessing lakes. Its validity is supported by external confirmation of the response of variables to stressors, usually from published or other independent studies. While direct observation of reference lakes is the preferred approach, paleolimnological reconstruction and model extrapolation are also possible approaches for reference condition determination.

## ***2. Paleolimnological Reconstruction***

Many groups of organisms in lakes leave remains in the bottom sediments. Some of the remains are resistant to decay and become a permanent biological record of life in the lake. By comparing past biota with present-day biota of many lakes, past environmental conditions can be inferred. Several groups of organisms have been used for paleolimnology: diatoms and chrysophytes, sponges, bryozoans, cladocerans, and chironomid larvae. Of these, diatom frustules and chrysophyte scales have been used most often, and most successfully, to infer past chemical conditions (e.g., Charles and Smol, 1994). The



preserved diatoms provide an integrated record of the diatom assemblage in the lake. A sample of the top 1 to 2 cm of lake sediment contains a representative sample of diatoms from the most recent 1 to 3 years. If the lake sediments remain undisturbed, then diatoms and chrysophytes preserved in lake sediments are integrators of lake history (Charles et al., 1994; Dixit et al., 1992).

Inference of past nutrient conditions from biological remains is based on strong relationships of biota with water quality. Many algal species are indicators of particular nutrient conditions, and the assemblage found can therefore be used to infer nutrient conditions. Environmental variables such as alkalinity, aluminum, dissolved organic carbon, salinity, nickel, conductivity, calcium, TN, TP, Secchi transparency, and trophic state also have been inferred using diatom-based predictive models (Charles et al., 1994; Dixit et al., 1992; Fritz, 1990). Sediment cores can be calibrated with other information (e.g., varves, known contamination events, radioisotopes, pollen) to obtain time series with resolution of up to 1 to 10 years. Therefore, the diatom and chrysophyte fossil record can also aid in establishing reference conditions by enhancing the historical record of previous data collections and events.

Paleolimnological analysis, part of the Environmental Monitoring and Assessment Program protocol (U.S. EPA, 1994b), requires development of a data set that associates current environmental conditions with current surficial diatom assemblages. Present-day associations are used to infer past conditions based on fossil diatom assemblages in deeper sediment layers. Quantitative prediction is usually done in two steps: (1) development of predictive models (calibration or transfer functions) followed by (2) use of the models to infer environmental variables from fossil assemblages (Charles and Smol, 1994).

#### ■ Inference of Past Conditions

Inference of past environmental conditions from fossil assemblages requires a sizable calibration data set that includes both assemblages and environmental (chemical) measurements. The calibration data set typically consists of recent sediment samples (top 1 cm) with complete lake water quality and chemical estimation from at least 50 lakes. The calibration data set should include lakes that span the ranges of all important environmental variables that are being investigated. For example, development of predictive models for acidification requires a calibration data set that includes alkaline, neutral, and acidic lakes; development of predictive models for nutrient concentrations requires a calibration data set that includes lakes with high and low concentrations of nitrogen, phosphorus, and silica and combinations of the nutrients. The sedimented diatom assemblage is identified and enumerated for each lake in the calibration sample.

The first step is to determine whether species-environment relationships are strong enough to permit development of predictive models for inference of environmental conditions. Currently, this is done using canonical correspondence analysis (CCA) (Dixit et al., 1992; Jongman et al., 1987; ter Braak, 1986). CCA is an ordination technique that orders sites on environmental gradients. Unlike linear models such as canonical correlation, there is no assumption that species abundance is a linear response to environmental gradients. Instead, species are assumed to have a unimodal response to gradients, such that abundance of a species is reduced above and below the optimum value of an environmental variable (ter Braak, 1986). The assumption of modal responses, where each species has optimum values of nutrients, temperature, light, pH, etc., is more realistic for algae than are linear responses (e.g., Tilman, 1982). The CCA identifies environmental variables that have strong associations with species composition and therefore are suitable for predictive model development.

Models to predict values of environmental variables (e.g., nutrients) are developed with weighted averaging regression (Charles and Smol, 1994). The computer program WACALIB (Line et al., 1994) is

an efficient way to perform these calculations. The technique also uses the assumption of unimodal optima of environmental variables, as does CCA. The optimum condition for each taxon is the average of mean values for the environmental variable at sites in which the taxon is found, weighted by the abundance of the taxon (Charles and Smol, 1994). The inferred value of the environmental variable is in turn the sum of optima (for that variable) for all taxa at a site, weighted by the relative abundance of each taxon. Techniques have also been developed to quantify error and uncertainty of the predictions (Birks et al., 1990). Further documentation of these methods is in Charles and Smol (1994), Charles et al. (1994), Birks et al. (1990), and ter Braak and Juggins (1993).

### ■ Existing Diatom Databases

Paleolimnological databases exist for several regions of the country. The largest of these is the Paleocological Investigation of Recent Lake Acidification, which is for the Northeast, but other databases exist for the Upper Midwest and Florida. Paleolimnology to establish reference conditions for impoundments and reservoirs is not recommended because impoundments undergo succession of several years or more following inundation. A reference as an attainable condition thus would be impossible to define for reservoirs from paleolimnological data.

### 3. *Model Prediction and Extrapolation*

If few or no limnological data are available for a given lake or region, reference conditions can be predicted by inference or extrapolation of various models. Although extrapolation of models beyond their original calibration data is risky, it may be the only option to estimate reference conditions if no reference data exist or are likely to exist. There are two approaches: (1) using the morphoedaphic index method (MEI) and (2) extrapolating natural background nutrient loading that would occur under undisturbed conditions followed by estimation of nutrient concentrations and trophic state with a mass balance model. These methods are discussed in more detail in Chapter 8.

The MEI is the ratio of total dissolved solids in lake water to the mean depth of the lake. Several early studies suggested that the MEI was correlated with fish and phytoplankton production of lakes (e.g., Rawson, 1951; Ryder, 1961; Oglesby, 1977). The MEI approach was extended by Vighi and Chiaudani (1985) to predict phosphorus concentrations resulting from natural background loading in undisturbed watersheds—in short, to predict reference phosphorus concentrations. The MEI approach is simple and appears to be highly successful for a limited set of cool-temperate lakes. It has been largely ignored by North American limnologists, possibly because of its simplicity, and as a result, it has not been calibrated and tested for a wider variety of lakes. The approach is promising, but it needs to be recalibrated and tested with regional reference lake data sets.

Mass balance models are a means of estimating concentrations of substances (primarily nutrients) from knowledge of the loading into a lake and the hydrology of a lake (see Chapter 2, Section C). A mass balance model by itself will not establish reference conditions, but it will predict nutrient concentrations given certain loading values. Therefore, use of a mass balance model to derive reference conditions requires an estimate of natural background nutrient loading to a lake.

If a lake or lakes of a region are primarily stream-fed, an estimate of background nutrient loading may be made from stream water quality data with some method for selecting (or assuming) a reference distribution or reference value of stream nutrient concentrations.

Fulmer and Cooke (1990) used a frequency distribution approach combined with loading and mass balance models to estimate the reference conditions of a State's water bodies. They estimated the phosphorus concentration in 19 Ohio reservoirs based on the characteristics in the ecoregions in which the reservoirs were located. For the incoming phosphorus concentration, they used the 25th percentile of stream phosphorus concentration in four of Ohio's ecoregions (the best quartile). They termed the resulting phosphorus estimate the "attainable phosphorus concentration," suggesting that this was a conservative estimate of the stream phosphorus concentration attainable through waste water treatment, improvements in agricultural practices, and treatment of urban runoff in the watershed.

The authors then compared this estimated phosphorus value to that actually found in the reservoir after first transforming the values to the trophic state index values of Carlson (1977). The difference between the trophic state indices was termed "the restoration potential" of the water body. This would target those lakes that deviate the most from the attainable trophic state for that body. This approach is important because it combines the use of the ecoregion to estimate reference conditions for the reservoir with the emphasis of differing restoration potentials based on the specific characteristics of the individual reservoir. This simple but effective approach applies only to stream-fed lakes (principally reservoirs). Ground-water-fed and head water lakes would require one of the other methods for estimating loading that does not rely on stream concentrations.

Many states have ongoing biological criteria programs and have identified least stressed streams as reference sites. These biological reference sites could likewise serve as reference sites for stream nutrient criteria and background nutrient concentrations and loading. This method would be appropriate only for impoundments and flowage lakes, which are stream-fed, and not for lakes with substantial ground water input.

### **C. Initial Data Retrieval and Processing to Support Ecoregional Nutrient Criteria Development**

Nutrient data will be collected for site points (years 1990 to present) from STORET, the U.S. Geological Survey's NAWQA, and other acceptable databases and then will be grouped by nutrient ecoregion (Omernik's Level III aggregations). The headquarters nutrient team and Regional Technical Assistance Groups (RTAGs) will assess the data and will determine regional reference condition values for TP, TN, chlorophyll *a*, and Secchi depth.

A regional reference condition can be selected using either of two approaches. In both instances, the intention is to select an optimal reference condition value from the distribution of an available set of lake data for a given physical class of lakes or reservoirs.

One approach is to select a percentile from the distribution of measured variables of known reference lakes (e.g., highest quality or least impacted lakes of that size class of all lakes in the region). The variables of initial concern are TP, TN, chlorophyll *a*, and Secchi depth. Because these reference lakes are already acknowledged to be in an approximately ideal state, it is reasonable to select an upper percentile (i.e., a representation of the lesser nutrient quality of the distribution of the reference lakes) as the reference condition. EPA generally recommends the upper 25th percentile (Figure 6.1(a)).

The other approach is to select a percentile from all lakes in the class or from a random sample distribution of all lakes in the class. In this case, it should be a lower percentile (i.e., a representation of the better end of the range of all lakes) because the sample is expected to contain at least some degraded lakes if it is an entire population or a truly random selection. This option is most useful in regions where the number of legitimate natural reference water bodies is usually very small such as highly developed

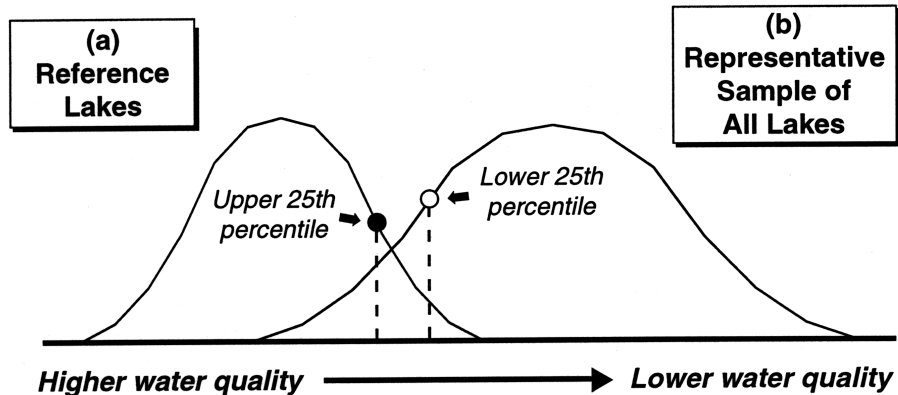

**Figure 6.1. Two approaches for establishing a reference condition value.** Note: Percentiles are based on order statistics, statistics derived from ordering data from low to high or high to low. In the case of TP, TN, and chlorophyll *a*, higher concentrations of the variable result in lower water quality. Consequently, the scale presented above is ordered from low to high. A similar analysis of Secchi depth, however, would require ordering the data from high to low because higher Secchi disk readings are associated with higher water quality.

land use areas like the agricultural lands of the Midwest and the urbanized east or west coasts. EPA's recommendation in this case is usually the lower 25th percentile, depending on the number of natural reference lakes available (Figure 6.1(b)). If almost all reference lakes are impacted to some extent, then the lower 5th percentile might be used in an effort to approximate previous natural conditions.

It should be noted that the upper 25th percentile of a reference lake distribution and the lower 25th percentile from a representative sample distribution are general recommendations. The actual distribution of the observations and knowledge of the inherent regional water quality are also determinants of the threshold point chosen.

In Figure 6.2, TP is the variable of concern and illustrates the presumption that, all else being equal, these two alternative methods should approach a common reference condition along a continuum of data points. In this figure, the upper 25th percentile of the collection of reference lakes produces a TP reference condition of 30  $\mu\text{g/L}$ . The lower 25th percentile of the random sample of lakes produces a value of 35  $\mu\text{g/L}$ . The shaded portions of both distributions in Figure 6.2 indicate those lakes in each sample distribution that presumably would not meet reference expectations. It should be noted that (1) variability about these selected points is a factor in any such estimation, (2) this is a reference condition value subject to further evaluation before a nutrient criterion is developed, and (3) given that overenrichment is a recognized water quality problem, it must be expected that some fraction of the present measured water bodies would be so identified.

Because there is little distinction in this case, the Agency may choose to select either 30  $\mu\text{g/L}$ , 35  $\mu\text{g/L}$ , or the intermediate 33  $\mu\text{g/L}$  as the TP reference condition value. Each State or Tribe should similarly calculate its reference condition using both approaches to first determine which method is most protective. Then they should use that most protective approach for their subsequent reference condition calculations.

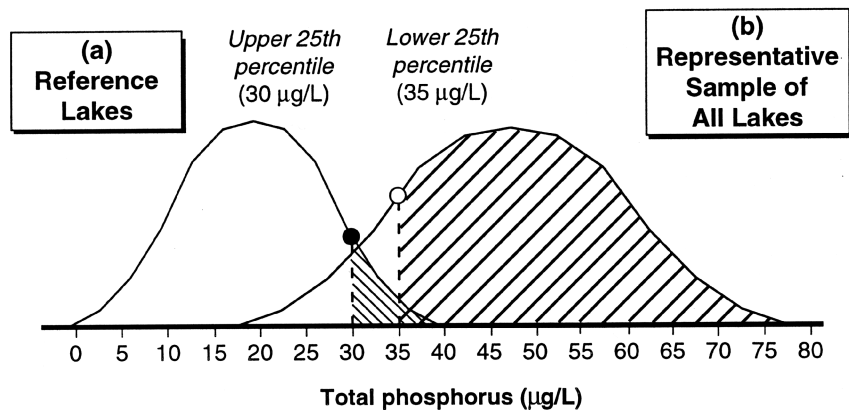

**Figure 6.2. Two approaches for establishing a reference condition value using total phosphorus as the example.**

In most instances, EPA will calculate regional nutrient criteria reference conditions by first subdividing the data set into size classes of lakes. These subdivided data then will be assessed to determine if further subdivision of the regional boundaries is necessary. If data tend to cluster within a nutrient ecoregion, it may indicate the need for further refinement of those regional boundaries into subregions.

Once the regional boundaries are determined, a frequency distribution selection for each lake class per region or subregion is established at the lower 25th percentile. This is because the available data cannot usually be assured of being all reference condition quality. The data are obtained from a wide variety of sources with an equally wide array of documentation and quality assurance procedures. The Agency policy is to choose consistently lower end percentiles to assure the appropriate protection of the uses. This conservative effort, together with consulting the RTAGs in determining these regional criteria, is designed to help protect against setting the regional criteria either too high or too low.

Another element that must be considered in setting the reference conditions is where and when the data were gathered. If the sample size is large enough, the time of year the individual samples were taken may not matter; either all seasons will be represented or most of the data will cluster about an appropriate index season. Similarly, surface grab or depth-selected samples or composite samples may not matter if the diverse data set is large enough. However, when these factors are significant, the most indicative time of the year should be used as the index period. Alternatively, criteria should be developed for each season of the year. Likewise, the depth and location of sampling in the lakes in question that best reveals the presence and amount of nutrients in that system should be used. These are usually within the upper meter of surface water from a central portion of the water body or open water area near the main discharge location. This guideline applies to measurement of both causal and response variables. Once again, it is preferable to err on the side of the environment.

Once the reference condition is determined, the other four elements of criteria development should be incorporated in the process. First, the reference condition should be compared with the historical information for that area. Are things getting generally better or worse than before? Model predictions not only fill the void when there is a lack of sufficient reference condition data, but they may help answer this

trend question. All of this accumulated diverse information requires careful and objective review by the RTAG specialists as part of the nutrient criteria development process.

### Case Study

Data from Minnesota provide an example of how this technique might be applied to help determine appropriate reference conditions for an ecoregion. Though Minnesota's P criteria, which were eventually developed, were not established using the specific technique described in this text, it is instructive to see how the percentiles compare between a reference population and a random or preexisting database (as was the case in Minnesota). The table below displays phosphorus concentration at the 75th percentile for a distribution of reference lakes and 25th percentile for the distribution of total assessed lakes for three ecoregions.

In the NLF, the 75th percentile of the reference lakes was slightly higher than the 25th percentile for the random population (note that the random population would include reference lakes as well in this instance). The P criteria for that region was set just above the 75th percentile for the reference lakes. In the NCHF ecoregion, the 75th percentile of the reference lakes was again higher than the 25th percentile for the random population. The P criteria for this region fell between these two values. In the highly agricultural WCBP the 75th percentile of the reference lakes was well above the random data set; however, the random data set is rather small and there is substantial overlap between the two data sets (i.e., 12 of 45 lakes in the random data set were reference lakes. In the case the P criteria was set below both values but was relatively close to the 25th percentile for the random data set. This analysis suggests that this technique may merit attention in those regions where there are both reference and larger random or preexisting data sets for the type of analysis.

**Finding Reference Condition Values for Phosphorus ( $\mu\text{g/L}$ ) Concentration Based on Reference and Total Assessed Distributions by Ecoregion in Minnesota**

<b>Ecoregion</b>	<b>75th Percentile of Reference Lakes</b>	<b>25th Percentile of Total Assessed Lakes</b>	<b>P Criteria for Swimmable Use</b>
Northern lakes and forests	27 (n=30)	16 (n=543)	30
North central hardwood forest	50 (n=38)	35 (n=368)	40
Western corn belt plains	150 (n=12)	97 (n=45)	90

# CHAPTER 7

## Nutrient Criteria Development

- A. Introduction: Elements of Nutrient Criteria
- B. Development of Eco-regional Nutrient Criteria
- C. Development of State Nutrient Criteria
- D. Using Criteria to Assess Water Resource Attainment

### A. Elements of Nutrient Criteria

As presented in Chapter 1, five principal elements should be used to develop nutrient criteria. These five elements are summarized below.

#### *1. Investigation of the Historical Record*

Investigation of the historical record entails collecting and evaluating both anecdotal information and data sets relative to the lake and watershed of concern. This information may be gathered from long-standing residents of the area, local fishermen, and county, State, and Federal natural resource management and land use planning agencies. Academic institutions also are an excellent source of information; often, faculty will have extensive water quality or fishery information collected over several years as research or teaching projects. Occasionally, water supply authorities will have collected long-term historical data records such as phytoplankton composition or Secchi depth. In other instances, high-quality data sets may exist that are several decades old, such as the information collected by Birge and Juday on Wisconsin lakes. But most historical data are likely to consist of isolated observations on a small subset of lakes.

More recently, monitoring data may be available from volunteer monitoring organizations. Because these reports are not always common to routine literature reviews of published material, direct contact with the organizations may be necessary to obtain this information. The same applies to the many “gray literature” reports prepared by county, State, and Federal agencies.

Historical information, both quantitative and anecdotal, can be valuable, but it is often the most difficult to interpret. Nonetheless, it provides the investigator with a perspective on the relative quality of the resource over time. The principal difficulty is compatibility of methods used to collect historical data with current data collection methods and quality control. Although methodologies for water quality and basic limnology have not changed greatly in the past 25 years, all data must be carefully evaluated to determine if methodological biases would be introduced by combining historical and recent data to determine trends and historical reference conditions. Typically, the most compatible data are those that require the least sophisticated equipment to collect: Secchi transparency, total suspended solids, and algal species composition (phytoplankton, periphyton). Nutrient concentrations and chlorophyll concentration are sensitive to methodological changes, and biases are magnified if the measured concentrations are near or below the method detection limit.

EPA data sets on the STORET system are also available. In addition, the National Nutrient Criteria Program has information selected from STORET and augmented with additional State and academic information. In many instances, these data are of recent origin (e.g., since 1990), and a true historical perspective is not possible without the additional, older information. An illustration of the significance

of this historical information is the lake database available in Wisconsin. The famous Birge and Juday studies extend back to the turn of the century, and in many cases, these monitoring data have been maintained by State or universities through the present. Such background information is invaluable in understanding the inherent nature of a particular system, and it lends the proper and accurate perspective necessary to distinguish natural from cultural enrichment. A good historical database is important for setting proper nutrient criteria and standards because it provides knowledge of what has happened before, what the normal natural trends are, what disruption humans have or have not caused, and what remediation efforts are possible.

## ***2. Establishment of the Reference Condition***

Present optimal lake conditions for an area must be reliably established (see Chapter 1). This is the other half of the lake assessment necessary for a responsible evaluation. The historical record described above tells the historical conditions for the lake or lakes of concern. The reference condition tells the best present status of those lakes. In some instances, conditions were much better in the past because of less development; the present reference condition reveals how much the system has declined. On the other hand, depending on how far back the historical record extends, it may be that the present reference condition is better. For example, compare the degradation of the cut-out-and-get-out era of logging in the early part of this century with the present-day forest reclamation and land management efforts. In this instance, we can be apprised of improving or declining trends in nutrient status over past performance.

## ***3. Use of Models***

Models that have been calibrated and verified can be used to extrapolate data to a projected nutrient condition where existing data are either insufficient or unavailable. Often this entails using data in a similar lake in the same region or making a reasoned projection, accompanied by a set of clearly stated assumptions, from data in one point in time to estimate conditions in the future. In some instances, surrogate information such as Secchi depth and chlorophyll *a* concentration can be used to estimate phosphorus concentration. Chapters 2 and 9 contain more information in this regard.

## ***4. Expert Assessment of Information***

Elements 1 through 3 are essentially data-gathering and data analysis processes. Elements 4 and 5 are interpretive processes because the information gathered should be assessed for veracity and application. To do so, each EPA Region has a Regional Technical Assistance Group (RTAG) of specialists to help the Agency and States establish the nutrient criteria for adoption into State water quality standards. RTAG members should be experts in limnology, water resource management, land resource management, and fisheries management as well as other appropriate specialties necessary to make an objective and exhaustive evaluation of the information. RTAGs are described in more detail in Chapter 1.

## ***5. Attention to Downstream Effects***

Before any criterion for any given class of lakes can be adopted, the potential impact on downstream waters must be considered. If the criteria do not provide for the attainment and maintenance of proximal downstream water quality, the criteria in question should be adjusted accordingly.



## **B. Development of Ecoregional Nutrient Criteria**

### ***1. Regional and Lake/Reservoir Type Classification***

Initial efforts should deal with geographic classification. EPA has developed a national ecoregion-based classification system to initiate the process. The country has been divided into nutrient ecoregions using the initial EPA nutrient ecoregion map (see Figure 1.3). States and regions are encouraged to develop subregions within the 14 main nutrient ecoregions, as supported by new data evaluation. The subregions should be based on natural land forms and environmental characteristics such as soil type, parent material, slope, natural vegetative cover, climate, and hydrology, as opposed to cultural land uses.

The next step is to carry out physical classification procedures such as subdividing all lakes in the data set into similar classes, most commonly, lakes of similar size (e.g., 10 to 50 acres, 51 to 150 acres, 151 to 300 acres, and larger). Volume and retention time also should be used and are better related to likely biological responses in most nutrient loading models (see Chapters 6 and 9).

Once the system of physical classification has been established, data for all lakes or reservoirs in that class should be compiled and subsorted. EPA also is developing a nutrient database using STORET and other data sources that will be available as an initial data collection effort. This database will include information for TN, TP, chlorophyll *a*, and turbidity as the four main parameters, as well as other potentially relevant measures. EPA will use this database to support development of the ecoregional nutrient criteria. The database should be expanded by additional State, academic, and Federal information acquired from colleagues in the area. All data must be sorted for quality and applicability. Issues that should be addressed before incorporating a data set into the criteria development process (see also Chapter 4) include how carefully the samples were collected, from what season and locality the samples were taken (especially whether samples were taken from degraded or reference quality waters), how well analyzed the samples are, how well the sample locations were pinpointed, and how often the samples were replicated.

This physical classification process may reveal unique lakes or sets of lakes that defy the routine classification approach. Examples may include remarkably oligotrophic lakes perceived as exceptional natural resources, dystrophic or stained acid bog lakes that may have a separate biological response to enrichment, and lakes or reservoirs that are already intentionally overenriched. Each State or Tribe and EPA Region will have to address such conditions as most appropriate to that region, while still adhering to the objective of improving the trophic condition of those lakes by reducing cultural eutrophication.

### ***2. Conversion of Ecoregional Data to a Reference Condition and Preliminary Nutrient Criteria***

From metadata in the historical database, candidate reference sites (element 2) can be selected based on the location of the lakes and their relative lack of watershed development. This effort should divide all lakes (or reservoirs) into potential reference and potential test systems. The least developed systems should be candidate references. These sites should be visited and sampled to confirm their quality. It is important to recognize that seasonality must be accounted for, so the sampling and assessment process will take at least a year or two, and potential seasonal variability in the data should be assessed. (This is discussed in detail in Chapter 6.)

If data are scarce, modeling (element 3) may be necessary to help establish the reference condition (i.e., that compilation of reference site characteristics that best represents the optimal trophic condition

for lakes or reservoirs of that class). Modeling, like paleolimnology, can be used in a weight-of-evidence approach to develop nutrient criteria, much like the frequency distribution approaches discussed in Section C (below), but the precision, accuracy, and suitability of the model(s) should be carefully assessed before deciding on this approach.

The RTAG then should assess the classification system and attendant data (elements 1-3) to establish the reference lakes and derived reference condition (element 4). This will involve selecting the appropriate cutoff point in the distribution of values for each set of reference lakes for each physical classification. These adjusted values becomes the candidate criteria.

The basic procedure described below is recommended to process available data to establish nutrient reference condition and subsequent nutrient criteria. This approach may be taken on a regional or State scale, and the sharing of data and reference condition information requires that a consistent methodology be employed. States may elect to use approaches distinct from the methods described in this manual, but such alternative approaches must be scientifically defensible and approved by EPA. They are not meant to be precluded from consideration simply because they are not described in this edition of the manual.

### ■ Data Compilation

Data should be compiled from STORET and other pertinent Government files as well as State, university, and other sources. All information should be reviewed and converted to the common database already established by the National Nutrient Criteria Program (specific information may be obtained from the EPA Regional Nutrient Coordinator or EPA Program Headquarters in Washington, DC).

Ideally, the data collection and compilation procedures used for classification and criteria development will be the same as those used for assessment purposes. However, it is recognized that at least initially the procedures may differ.

### ■ Data Reduction

Data reduction (from the data set that has been screened for impacted sites) should be conducted so that presumably most, if not all, data points remaining are candidate reference sites.

- If multiple data are recorded for a given site on the same date and are adjustable to a normal distribution, select the median value per station for each of the four primary variables of TP, TN, chlorophyll *a*, and Secchi depth (e.g., replicate samples or multidepth sampling). This equates multiple data from some stations with single grab samples at others.
- Where analytical results are reported as below detection limits and the method of analysis is an EPA-approved or “standard” method, use the reported minimum detection limit to calculate the median value. If the median exceeds these minimum detection values, no further analysis is necessary. If any of the minimum detection limit values exceed the median, statistical methods applicable to censored data should be used.
- If indicated, separate data according to the season when the information was collected. In temperate regions, seasonal criteria may be needed.
- Compile a single seasonal median value for each given lake or reservoir from all median station values for that water body.

## ■ Physical Classification

Physical classification is based on the metadata provided in the data set for each lake within a given ecoregion or subcoregion. Area and depth can be used to establish a volume-based classification scheme. Unique systems should be separated out as distinct categories. Further subdivision may be done on the basis of watershed size if necessary. The process should be one of progressive subdivisions to smaller and smaller classes with less and less within-class variability. These classes then can be tested for statistically significant differences using analysis of variance techniques. This step may recombine some of the initial subdivisions so that an optimal set of lake classes results.

## ■ Reference Condition Determination

Reference condition determination can be based on a further review of the metadata to determine which lakes within a class have the least developed watersheds (e.g., perhaps 50 percent or more of the land area in natural vegetative cover, usually forested and with a fairly expansive area of the shoreline [perhaps 65 or 70 percent] undeveloped). These lakes then can be designated as reference sites and their median values for TP, TN, chlorophyll *a*, and Secchi depth arrayed respectively in a frequency distribution from higher to lower water quality. The upper 25th percentile then is selected as the ecoregional reference condition. When an adequate number of acceptable reference lakes is not available, the alternative is to use all of the data or take a random sample of what is available and use the lower 25th percentile as the ecoregional reference condition (see Figure 6.1 and accompanying text).

### *3. Refine Ecoregion Reference Condition Values*

Newly collected data can be combined with existing information to refine the reference values for both the EPA regional reference conditions and the State or Tribal references as well. Grants/contracts may be awarded to States and Tribes via the regional coordinator to develop sufficient current databases, especially where information is lacking for particular water body types or geographic areas of the nutrient ecoregion.

### *4. Evaluation by Regional Teams to Establish Ecoregional Criteria*

The RTAG obviously must incorporate all elements: history, reference condition, data models if employed, and downstream effects when establishing the ecoregional nutrient criteria. In doing so there are several key factors which should be noted:

## ■ Reference Condition

RTAGs will be asked to review the preliminary material described above and determine if the reference condition values are appropriate for the States in that EPA Region. Because RTAGs will include State agency members, regional or local concerns should be able to be addressed in a timely manner. The EPA National Nutrient Criteria Program data compilation and quality assurance procedures will help in the data sorting process. Headquarters also will award grants/contracts as needed to States to help fill in data gaps through the establishment of data collection programs.

## ■ Antidegradation

A critical requirement for the use of reference conditions associated with nutrient criteria is the EPA antidegradation policy, which protects against incremental deterioration of water bodies and reference conditions. An observed downward trend in the conditions of reference sites cannot be used to justify relaxing reference expectations, reference conditions, and the associated nutrient criteria. Once established, nutrient criteria should only be refined in a positive direction in response to improved conditions.

Without antidegradation safeguards, even the establishment of reference conditions and nutrient criteria could still allow for continual deterioration of water quality. For example, construction and development in watersheds containing lakes considered to be of excellent quality and which have been designated as reference lakes for a region could result in a degradation of nutrient levels and related variables and enhance eutrophication. If a number of the reference lakes in a region have suffered such deterioration, the reference conditions established from the set of reference lakes will have been degraded relative to their earlier state, and the comparative standard will have been lowered.

To combat this, the States should implement an effective antidegradation policy that promotes continually improving lake conditions. As an example, Maine has an antidegradation policy that requires that lakes remain stable or improve in trophic state (Courtemanch et al., 1989; NALMS, 1992). The RTAG should assume a comparable sense of antidegradation responsibility.

## ■ Establishing the Maximum Upper Limit of Eutrophication

The review of reference condition data, an understanding of regional nutrient dynamics, and the description from Chapters 1 and 2 of clearly over-enriched conditions should all contribute to a sense of just how much variation about the reference condition the RTAG should accept in establishing criteria.

The light-limited condition of *hypereutrophy* (TSI 70, TP of 0.1 mg L<sup>-1</sup>) is characterized by dense algal and macrophyte communities and should be considered undesirable under all circumstances. It is recommended that no criterion ever be set higher than this value, regardless of designated use, unless it can be demonstrated that the natural reference condition is this high.

## ■ Designated Use

The States are expected to develop nutrient criteria to protect their designated uses. The EPA ecoregional criteria should be protective of at least most of these uses.

## ■ Endangered Species

In all instances, the EPA National Nutrient Criteria Program will strive to ensure that nutrient criteria are protective of any identified threatened or endangered species in involved waters. RTAGs also should keep this responsibility in mind as they evaluate proposed State/Tribal nutrient criteria. The RTAG should coordinate with the regional USFWS office to determine if any endangered species are involved. Where threatened or endangered species may be affected, the nutrient conditions appropriate to their support should be included in the criteria.

## ■ Downstream Effects

The final step in establishing the nutrient criteria is to assess the potential downstream effects (Section 131.10 (b) of the Clean Water Act) of setting a criterion for a given class of lakes. Will this level of nitrogen and phosphorus and attendant algae or turbidity levels when present in the water body have detrimental effects on the downstream receiving waters? Will it provide for the attainment and maintenance of water quality standards in these waters? Downstream receiving waters are considered to be those immediately below the lake or reservoir and within a few miles of it. The Nation's estuaries and coastal marine waters are ultimately the recipients of all discharges to surface waters and should benefit from such efforts, but the intent is to accomplish this indirectly by a sequential and cumulative improvement of our surface waters. For example, the Atlantic Ocean is eventually the beneficiary of lake enrichment improvements in the Cobbosee Lake Watershed in Maine, but the individual program manager need only worry about the downstream effects on the Kennebec River in setting nutrient criteria. The cumulative sequences of similar improvements progressing downstream are expected to help achieve coastal nutrient abatement.

Once the RTAG specialists agree and document their decision that no adverse effects will result and standards are met downstream, or that the downstream waters will be enhanced, then the tentative criteria can be adopted. However, if downstream waters are not adequately protected at the level of discharge associated with the proposed criteria, then that value should be adjusted accordingly. Loading estimation models will be helpful in making this judgment as will enlisting the assistance of managers associated with that downstream water body. It may be possible to coordinate management efforts and criteria to the benefit of both water resources and at a cost savings in management and monitoring by addressing conditions on both systems at the same time.

### *5. Examples of the Deliberation Associated with Development of a Nutrient Criterion*

To help illustrate the role and responsibility of the RTAGs, an abbreviated hypothetical illustration of the reasoning applied to nutrient criteria development follows: Using the 33 µg/L TP reference condition as an example, this value can be evaluated against historical records for reference lakes. The reference condition of 33 µg/L suggests a gradual rise upward in ambient TP, from about 20 µg/L 100 years ago, with a projected further upward trend indicated by use of demographic, land use, and hydrological models. The RTAG therefore concludes that setting a criterion any higher than the present reference condition would eventually lead to an unacceptable trend in water quality degradation due to expected development increases. The group further determines that because many of the reference lakes are located in the upper reaches of larger watersheds, these nutrient levels are inherently lower than those in lakes and reservoirs further downstream. If the model projections are accurate, the downstream lakes also will be enriched, and any increased load implied by raising the criteria above reference levels will hasten their cultural eutrophication. The RTAG therefore concludes that it will be prudent to set the criterion at 28 µg/L TP.

Alternatively, the 33 µg/L reference condition is determined to represent very little change over time, suggesting a dynamic stability in the area. In fact, the historical record shows, and a paleolimnological study by a local college confirms, that matters were much worse just 50 years ago when postwar logging and land development efforts peaked in the area. Many farms are now reverting to woodlots, and much of the land is being purchased by the State for natural and recreational uses. The reference lakes are all much lower in nutrient loads because they were protected from development even 50 years ago. It is concluded by the RTAG that the criterion can be safely set at 37 µg/L, and when implemented, the lakes of the region will remain in their mesotrophic, recovered state. In fact, further reductions for the other

lakes may be unlikely because of sediment releases of the phosphorus they originally received, while the demographic and loading projections strongly suggest that a manageable stability of between about 33 µg/L and 40 µg/L is very likely. Downstream waters will be unaffected by this action because ambient stream concentrations are presently in this range, and USFWS reports no endangered species in the area. Therefore, the specialists conclude that 37 µg/L is the appropriate criterion. We will use this hypothetical value as an illustration for the remainder of this chapter. (Keep in mind, however, that the alternative of 28 µg/L also is possible.)

Thus, the final derived ecoregional criteria for TP could be, depending on the circumstances, either the reference condition value of 33 µg/L, 28 µg/L, or 37 µg/L. The bracketed reference condition value in Figures 7.1, 7.2, and 7.3 shows this range of these hypothetical options.

State and Tribal nutrient criteria development can follow this same protocol described above except overall EPA ecoregional criteria should be used as a guide as States and Tribes establish their own nutrient criteria levels to protect designated uses.

### **C. Development of State Nutrient Criteria**

EPA encourages States and Tribes to use the nutrient criteria technical guidance manuals and ecoregional nutrient criteria when developing their own nutrient criteria. EPA intends to issue the regional nutrient guidance under section 304(a) of the Clean Water Act (CWA). According to EPA's regulations, States/Tribes should establish their numeric water quality criteria values based on (1) EPA's section 304(a) guidance (in this case, the appropriate regional nutrient criteria), (2) EPA's 304(a) guidance modified to reflect site-specific conditions, or (3) other scientifically defensible methods. (See 40 CFR §131.11(b)(1).) If the State/Tribe has additional data that it believes justify adoption of a different value or set of values, the State/Tribe should be prepared to explain the site-specific conditions or scientifically defensible methods that make it reasonable to depart from the regional nutrient criteria guidance. If EPA approves the State's/Tribe's nutrient criteria, it becomes effective for the purposes of the CWA. If no action is taken by the State or Tribe involved, EPA may propose to promulgate criteria based on the regional values and best available supporting science at the time. These values then will be used as the nutrient criteria for that State or Tribe. It is important to note that although nutrient criteria may be new, the EPA-State criteria and standard process itself is already well established.

#### ***1. Designated Use***

Section 303(c) of the CWA as amended (Public Law 92-500 [1972], 33 U.S.C. 1251, et seq.) requires all States to establish designated uses for their waters. EPA's interpretation of the CWA requires that wherever attainable, standards should provide for protection and propagation of fish, shellfish, and wildlife and provide for recreation in and on the water (section 101(a)). Other uses identified in the act include industrial, agricultural, and public water supply. However, no waters may be designated to be used as repositories for pollutants (see 40 CFR 131.10(a)). Each water body must have legally applicable criteria that protect and maintain the designated use of that water.

Changes in lake condition that begin to occur at points or in regions along the trophic continuum could be informative as States establish criteria to protect designated uses. Table 7.1 illustrates some use-related problems that tend to occur along the trophic spectrum for temperate U.S. lakes.

Also discussed below are general guidelines for developing criteria to protect selected designated uses. The values included here (and in Table 7.1) are *not* intended to represent proposed EPA or State ecoregional nutrient criteria. Rather, they illustrate ranges of parameters associated with the impairment of some traditional uses in some areas of the country. Criteria to protect these uses should be developed on a regional basis and should be consistent with EPA ecoregion criteria.

**Table 7.1. Changes in Temperate Lake Attributes According to Trophic State (adapted from Carlson and Simpson, 1995)**

TSI Value	SD (m)	TP (µg/L)	Attributes	Water Supply	Recreation	Fisheries
<30	>8	<6	Oligotrophy: Clear water, oxygen throughout the year in the hypolimnion			Salmonid fisheries dominate
30-40	8-4	6-12	Hypolimnia of shallower lakes may become anoxic			Salmonid fisheries in deep lakes
40-50	4-2	12-24	Mesotrophy: Water moderately clear but increasing probability of hypolimnetic anoxia during summer	Iron and manganese evident during the summer. THM precursors exceed 0.1 mg/L and turbidity >1 NTU		Hypolimnetic anoxia results in loss of salmonids. Walleye may predominate
50-60	2-1	24-48	Eutrophy: Anoxic hypolimnia, macrophyte problems possible	Iron, manganese, taste, and odor problems worsen		Warm-water fisheries only. Bass may be dominant
60-70	0.5-1	48-96	Blue-green algae dominate, algal scums and macrophyte problems		Weeds, algal scums, and low transparency discourage swimming and boating	
70-80	0.25-0.5	96-192	Hypereutrophy (light limited). Dense algae and macrophytes			
>80	<0.25	192-384	Algal scums, few macrophytes			Rough fish dominate, summer fish kills possible

## ■ Outstanding Natural Resource Waters

Some waters of the State may require special criteria based on unique characteristics of that water body. Such characteristics might include undisturbed or unique watersheds that are markedly different from other watersheds in the State. In some States, naturally formed lakes are a rarity and may need to be protected by criteria different from those used for man-made lakes or reservoirs. Some lakes may include rare or endangered species of plants, invertebrates, or vertebrates that need to be protected. Such lakes are the very best of the reference set and are most in need of protection by rigid State and Tribal antidegradation policies and procedures.

## ■ Aquatic Life Uses

Aquatic life uses, including fisheries, are heavily dependent on the initial condition of the resource. Species will change as a function of trophic state, and it may be difficult to defend why one species is necessarily “better” than another. The use of reference lakes and their accompanying biota is one measure that can be used to predict the species that should be expected in a region.

Few taxonomic groups have been observed over the entire trophic spectrum. The best known are those that have been used as trophic state indicators because these are known to change with trophic state. Of these, perhaps the best, and oldest, indicators are the dipteran larvae of the family *Chironomidae*. The Chironomids were known to change drastically as a lake became anoxic, and one of the first distinctions between oligotrophic (oxic hypolimnia) and eutrophic (anoxic hypolimnia) was the shift from a domination by *Tanytarsus* to one by *Chironomus* (Thienemann, 1921).

Numerous algal groups also are known to change with trophic state. The dominance of blue-greens in eutrophic waters is perhaps the most notorious, but changes in diatoms are well documented, perhaps if their frustules remain in the sediments. The paleolimnological record can help in setting the aquatic life criterion. Macrophytic plants also are known to change in density, location, morphology, and species richness (see above).

Although our knowledge of the dynamics of change in the biota as a function of eutrophication requires further development, there is sufficient evidence to conclude that eutrophication will bring species changes. If a lake has an existing aquatic life use, then that use must be maintained. Eutrophication will cause some species to change in relative abundance and cause others to disappear; therefore, nutrient enrichment may be incompatible with the maintenance of a specific biota. The ultimate extension of this concept is in the use classification of outstanding natural resource waters.

### *Fisheries*

Developing criteria to protect a specific fishery may be somewhat difficult because fish species in particular change as trophic state changes (Oglesby et al., 1987); therefore, different fishermen might be pleased or angry with each change in trophic state. For example, salmonids are dominant in waters with hypolimnetic oxygen but diminish as hypolimnetic anoxia develops (see Figure 5.2). This shift to a warm-water fishery may disappoint lake trout fishermen but delight walleye or perch fishermen. Carp and bullheads, which dominate the hypereutrophic waters, also have their advocates. It may be that criteria to protect specific designated uses could be established at the points of transition between dominant fish groups. Based on the work of Oglesby et al. (1987), the following general values (based on the available hypolimnetic dissolved oxygen response) might be suggested:



<b>TSI Range</b>	<b>TP Concentration</b>	<b>Aquatic Life</b>
<TSI 40-50	TP = <24 µg/L	Salmonid fishery
TSI 50-60	TP = 24-48 µg/L	Percid fishery
TSI 60-80	TP = 48-192 µg/L	Centrarchid fishery
>TSI 70-80	TP = >192 µg/L	Cyprinid fishery

Such a fishery categorization may present problems because some warm-water fisheries would thrive in waters falling below the reference condition (i.e., 50 TSI). However, consultation with fisheries managers and the public through the water quality standards review process should help resolve the issue of robust fish in otherwise overenriched waters.

### *Drinking Water*

Only in the past decade have we come to a full realization of the effect of eutrophication on drinking water (Cooke and Carlson, 1989). For years, the drinking water industry has recognized the effect of certain species of algae on taste and odor. However, trihalomethanes and other chlorinated byproducts also become connected with the effects of eutrophication (Palmstrom et al., 1988). It is now recognized that as a lake eutrophies, the species of algae will shift to those that affect taste and odor; these species will increase in density and increasingly affect the raw water quality. Turbidity will increase as the algae become more dense. The need to chlorinate then increases, and thus chlorination byproducts will increase as algae increase. Hypolimnetic anoxia will also increase the problems of iron and manganese control.

The reality is that drinking water plants must deliver a safe and potable product. As the effects of eutrophication are seen in the raw water, the cost of treatment increases. Unfiltered systems must give way to filtered water, then powdered carbon, and finally activated carbon. The run times of filters and of GAC filters decrease with increased algal densities. In short, eutrophication dramatically changes the cost and even the treatment process itself.

Several points along the trophic state continuum are relevant for drinking water supplies. The first is at a trophic state index (TSI) of 40 to 50, when the hypolimnion becomes anoxic. This is when iron and manganese problems would first be evident. At a TSI of 50, the turbidity of the water might be expected to exceed 1 NTU, and filtration of the raw water would become necessary. It is at a TSI of 50 that Arruda (1988) found that trihalomethane concentrations in the finished water exceed 100 mg/L in some Kansas treatment plants. Therefore, it is at this trophic state that extra measures or changes in the treatment process are necessary to control taste and odor without increasing the chlorine dose.

### *Recreation*

*Swimming/Primary Contact Recreation.* Criteria to protect a contact recreation use may be associated with the occurrence (or appearance) of certain phenomena that affect certain types of recreation. For example, in general, swimmers will not be affected by the trophic state of the lake, but resulting changes in transparency or change in species may be important. Some States and countries have prohibitions on swimming based on the depth from which a body can be seen on the bottom. This consideration is based on the possibility of seeing a drowning child. New Zealand has a swimming

prohibition on transparencies of less than 1.5 m (Smith et al., 1991), and several States have prohibitions based on transparencies of 2 or 3 feet. These transparencies would be equivalent to a TSI value of approximately 60, which, if transparency is related to phosphorus, would be equivalent to a TP value of 45 to 50  $\mu\text{g/L}$ . The density or frequency of algal scums also might discourage swimming. Because scums are often the result of dense populations of blue-green algae, then their frequency and density might be expected to increase as a lake becomes enriched. Excess nutrients feed not only nuisance algae growth, but potentially health-endangering bacteria, especially when human and animal waste may be involved.

*Boating and Secondary Contact Recreation..* It might be expected that the transparency of the water or the presence of algal scums would not deter boating, unless water skiing were involved. However, boating may be affected by the presence of dense beds of tall or floating macrophytes. Little research has been done on the relationship of macrophyte type and trophic state, but a paper by Swindale and Curtis (1957) suggests that the dominant taller plant forms increased as the conductivity of Wisconsin lakes increased. Because conductivity has been related to the background levels of nutrients in the water, a rough approximation would suggest that the trophic state where taller plants predominate would have a transparency of approximately 0.5 m, or a TSI of 70 (TP = 98  $\mu\text{g/L}$ ).

## 2. Hypothetical Illustration of the Relationship of State Criteria to Protect Designated Uses Compared With an Ecoregional Criterion for TP

In this hypothetical illustration (not applicable to any specific region), TP has been evaluated by EPA regional and Headquarters specialists for all reference lakes of a given class in the EPA nutrient program data set for a particular nutrient ecoregion or subregion. The distribution of the data has been assessed, and the upper 25th percentile of this distribution has been chosen as the ecoregional reference condition for TP (Figure 7.1). In this illustration, the upper 25th percentile is 33  $\mu\text{g/L}$ , and the RTAG has developed the criterion of 37  $\mu\text{g/L}$  TP as described in Section B above.

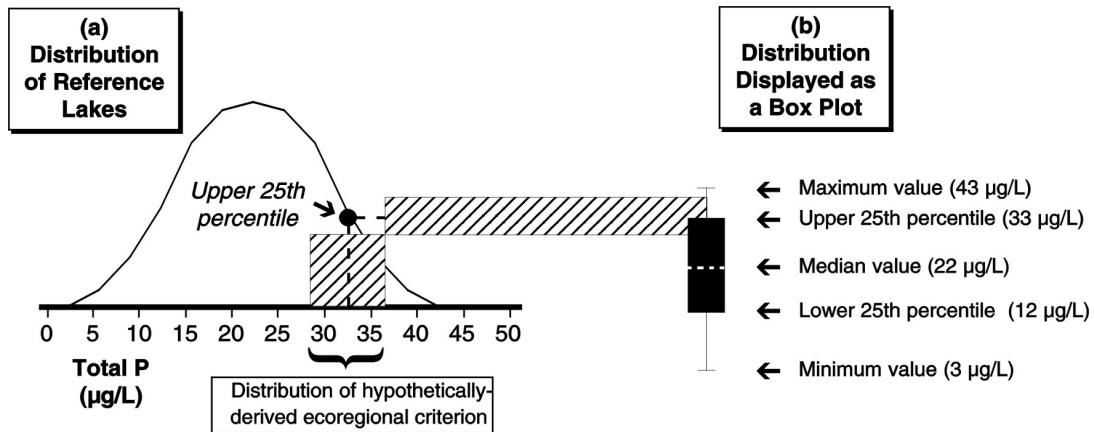

Figure 7.1. Development of a hypothetical ecoregional reference condition for TP from an ecoregion data set of reference lakes.

Calculations of these ecoregional criteria are done by the EPA National Nutrient Criteria Program in conjunction with the appropriate EPA RTAGs. The supporting data are obtained from Federal, State, and academic agencies and institutions in the region; all of these data become part of the national nutrient database. In establishing these regional criteria, EPA relies on the same five elements of criteria development described earlier for State and Tribal use (e.g., historical records, present reference site data, models if appropriate, regional expert interpretations, and consideration for downstream impacts).

The ecoregional criteria described in this manual are expected to be in part predicated on reference condition data gathered from at least high and low flow conditions, if not from year-round data. This is to make the process as straightforward and simple as possible while having consistent application of the methodology to all parts of the country, even those with seasonal variation.

However, it is evident that this approach may create a windfall gap between the criteria values and seasonally selected measurements in some localities. This would be analogous to conducting a perk test for a septic system in mid-August, which would have little bearing on the performance of the system during rainy April weather. States correct for this problem by setting their required test infiltration rates on a seasonal basis. Similarly, when large seasonal disparities exist in the reference data, the RTAG should develop two or more seasonal criteria instead of using an average criterion for each variable. One of these seasonal criteria should be for the growing season in that region.

Sampling to evaluate water body attainment with the subsequent standards employing these criteria will have to be carefully defined to ensure that State or Tribal sampling is compatible with the procedures used to establish the criteria. If State or Tribal observations are averaged over the year, balanced sampling is essential and the average should not exceed the criterion. In addition, to account for inherent variability, no more than 10 percent of the observations contributing to that average value should exceed the criterion (see also section D below).

Once an ecoregional criterion has been established and is subject to periodic review and calibration, any State or Tribe in the region may elect to use it as the basis to develop its own criteria to protect designated uses for each class of lakes in the State. This is entirely appropriate so long as the criterion is at least as protective as the basic EPA criterion for that region. This ecoregional criterion represents EPA's "304(a)" recommendation for protection of aquatic life use and is the value EPA would propose to promulgate in the absence of State or Tribal criteria.

Using this initial benchmark, the State or Tribe may proceed to classify its lakes first by size and other physical characteristics, and then further subclassify them by designated uses, e.g., criteria to protect large lakes and salmonids in a particular ecoregion or subecoregion. For each designated use class within the physical classifications, a set of reference lakes are again identified and the range of their TP concentrations plotted (from low to high), just done for the EPA regional criteria calculations. In this instance, the State may, if the data are known to be from all high-quality lakes, select an upper percentile (upper 25th percentile is recommended) of the distribution as the candidate criterion. If reference lakes are not available and the overall distribution of the lakes or a sample of the lakes is used instead, then the percentile should be selected from the lower end of the distribution (lower 25th percentile is recommended). The reader should bear in mind that the reference condition alone does not constitute the State criterion. It must be objectively assessed within an historical perspective and address downstream conditions before the criterion value is finally established.

### 3. *Frequency Distribution Approach*

The common characteristic of the frequency distribution approach is that it is data dependent. Usually, goals or criteria will be based on the data of the lakes themselves. This allows the construction of criteria based on the actual situation for the individual State or region. The establishment of nutrient criteria (much like establishing grades to reflect performance in education) requires both basic values or thresholds of expected accomplishment as well as sufficient flexibility to accommodate the uniqueness of each class. In this way, optimum performance is attained and the desired goal is reached.

The grading process, based on an accepted standard of performance (e.g., 75 percent is a passing grade), is analogous to the EPA ecoregional criteria derived from the best information available from existing reference lakes, paleolimnology, historical information and data sets, and appropriate models, as well as RTAG judgment and downstream consideration. Conversely, establishing criteria for each designated aquatic life use in this manner compares to “grading on the curve,” where the data characteristics of each use set the curve.

The EPA regional criterion means that a minimum expectation is established to prevent any decline in performance. But above the “passing grade,” the individual State or Tribe may develop its own criteria in accordance with the characteristics and designated use classification of its lakes. In Figure 7.3, most of the designated use criteria meet or exceed the passing grade.

Figure 7.2 is a hypothetical illustration of TP criteria developed for select designated use categories for an overall distribution of specific-sized lakes. The 37  $\mu\text{g/L}$  TP criterion is derived from the approach illustrated in Chapter 6 (see Figure 6.1) and the example of RTAG deliberations presented earlier in this chapter. Thus, for this example:

- Boating TP criterion = 40  $\mu\text{g/L}$
- Warm-water fishing TP criterion = 30  $\mu\text{g/L}$
- Cold-water fishing TP criterion = 24  $\mu\text{g/L}$
- Exceptional natural resource lake TP criterion = 10  $\mu\text{g/L}$

When this process is completed, Figure 7.2 can be simplified to show a series of criteria based first on the common physical similarity of the water bodies (they are in the same classification, e.g., same ecoregion, size range, and average depth) and next on their subclassification by designated uses (Figure 7.3).

#### **D. Developing Nutrient Criteria Implementation Procedures**

However done, a State’s or Tribe’s nutrient criteria should include a procedural protocol to implement the newly adopted nutrient criteria. The criteria and procedures should be reviewed by the RTAGs for concurrence and are subject to further EPA review and approval if submitted as part of State or Tribal standards.

The four initial criteria variables include two causal variables (TN and TP) and two response variables (chlorophyll *a* and Secchi depth or a similar indicator of turbidity). Failure to meet either of the causal criteria should be sufficient to indicate a criteria “excursion,” and usually the biological response, as measured by chlorophyll *a* and Secchi depth, will follow this nutrient trend. However, if the causal criteria are met but some combination of response criteria is not met, then there should be some

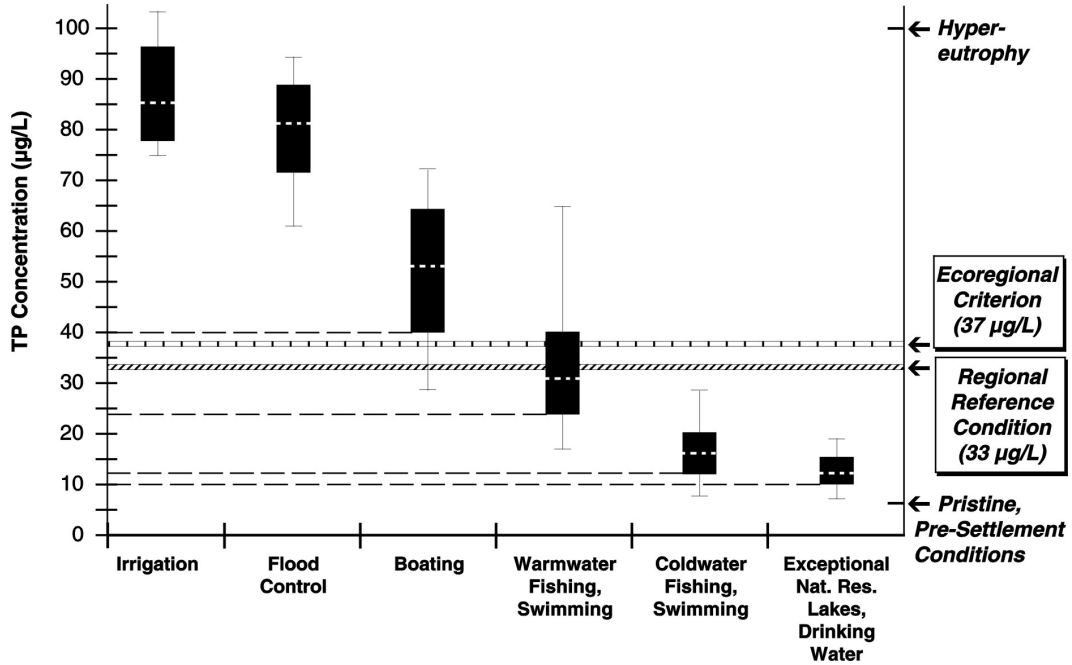

Figure 7.2. Development of TP criteria for select designated uses relative to the reference condition and ecoregional criterion for lakes of a specific size class.

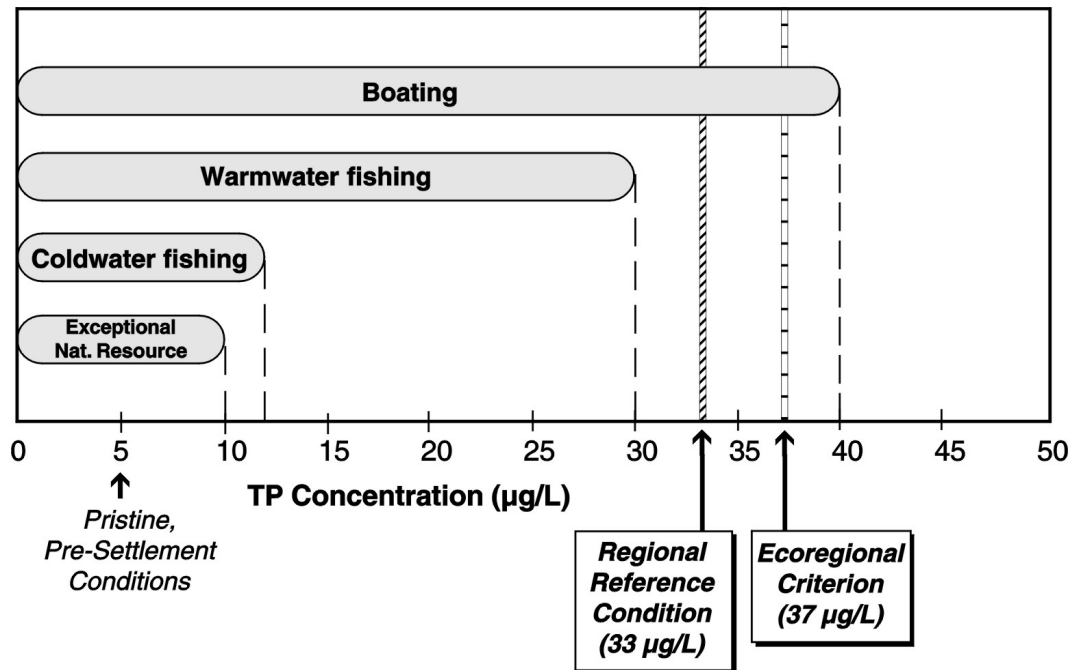

Figure 7.3. Simplified display of TP criteria for select designated uses in a specific size class.

means of determining if the lake in question meets the nutrient criteria. Two suggested approaches are described below.

### 1. Decisionmaking Protocol

One option is to establish a decisionmaking procedure equating all of the criteria. Such a rule might state: “Both TN and TP causal nutrient criteria must be met, and at least three out of five response criteria (e.g., chlorophyll *a*, turbidity, algal biomass, DO, macrophytes) must be met for three out of four sampling events during the June through August survey period over 2 consecutive calendar years of sampling. No sampling events may be less than 3 weeks apart [to avoid clustering sampling activities near a particular flow condition or runoff event], and flow conditions must be recorded as well so that watershed base flow and runoff events are evident and can be factored into the data assessment process.”

### 2. Multivariable Enrichment Index

The second option is to establish an index that accomplishes the same result by inserting the data into an equation that relates the multiple variables in a nondimensional comprehensive score much the same way an index of biotic integrity (Karr, 1981) does. An example of an enrichment index approach is presented in Table 7.2.

**Table 7.2. Example of an Enrichment Index Using a Hypothetical Lake**

Variable	Criterion	Hypothetical Lake	
		Mean Measured Value	Enrichment Index (EI) Score*
<b>Causal variables</b>			
Total P (mg/L)	≤0.020	0.048	5
Total N (mg/L)	≤0.250	0.502	5
<b>Primary response variables</b>			
Secchi depth (M)	≥ 1.0	0.6	3
Chlorophyll <i>a</i> (mg/L)	≤20	30	5
Macrophytes (% of phototrophic zone)	≤25	52	5
Algae (% blue-greens of spp. composition)	≤25	75	5
<b>Secondary response variables</b>			
Dissolved oxygen (mg/L in hypolimnion)	≥6.0	3.5	3
Fish kills (no in last 5 yr)	0	2	5
		<b>Enrichment Index Value** = 36</b>	

\* Each of the eight variables receives an EI score. The scoring procedure is: 0 = meets criterion; 2 = fails to meet criterion by 10%; 3 = fails to meet criterion by 25%; 5 = fails to meet criterion by 50% or more.

\*\* Enrichment Index Value is the sum of the EI scores. The maximum score achievable is 40.

If necessary, the scoring process can be weighted by seasons. Thus, different emphasis can be given to the results of winter surveys as compared with summer surveys, and year-round work can be conducted if necessary or desired. For example, greater weight perhaps by a factor of 2 could be given to the primary response variables in winter for north temperate lakes because these variables would normally be expected to be improved at this time of year. Similarly, the criteria for TP and TN might both be changed to lower concentrations for winter because less runoff or fewer fertilizer applications are expected. In the example, the lake fails anyway because it failed the criterion for either TP or TN (in fact it failed both). With a score of 36 out of a possible 40, it is also a prime candidate for extensive remediation management.

Such enrichment index scores are not intended at this time to be surrogate nutrient criteria. They may, however, serve as a “translator” to implement multiparameter criteria. However, like biological criteria index scores such as the Index of Biotic Integrity, the enrichment index may be a useful assessment tool. The merit of the index approach is that all lakes of a given classification can be rank ordered by score. This helps the resource manager plan the distribution of effort and funds over the entire resource base in one procedure.

#### **E. Frequency and Duration**

Frequency and duration are important concerns when evaluating any lake with respect to meeting criteria. This is a difficult process at this initial phase of the program because the data sources for criteria development are presently so diverse. In general, however, the method of data gathering for compliance should be as near as possible to that used to establish the criteria. Once this consistency is established, excursions from the criteria based on frequency and duration can be evaluated whether based on a decision rule or a multivariable index.

Frequency of “excursion” from a criterion is a decision that can be best established by the State or Tribe on the basis of their knowledge of the local water resources. An excursion that occurs less than 10 percent of the times when sampling is conducted (at regularly spaced or random intervals) may be considered acceptable. Duration of the excursion may be stipulated as a set period of time (e.g., 2 weeks, or as to not exist over more than two consecutive sampling intervals, whichever is the lesser period). The State or Tribe in consultation with EPA will need to specifically define these terms as appropriate to the region and should also determine the combination of these factors that constitutes an “excursion.”

## Unique Aspects of Criteria Development for Reservoirs

Reservoirs are important and effective traps of nutrients and sediments (e.g., Kennedy 1999, Straškraba et al., 1995). As such, they are often significant in the regulation of the material budgets of entire drainage basins. The potential importance of total phosphorus retention by reservoirs and its modifying influence on riverine nutrient budgets are demonstrated by water quality data for a three-reservoir cascade on the White River in northwestern Arkansas and southern Missouri. The three CE reservoirs, Beaver Lake, Table Rock Lake, and Bull Shoals Lake, exhibit differing water residence times and phosphorus retention rates, and, despite their close proximity on the same river, receive inflows with markedly different total phosphorus concentrations due to variations in loads from point and nonpoint sources (Figure 1). Beaver Lake receives inflows with relatively high total phosphorus concentrations, owing to agricultural land uses, but retains approximately 74% of the phosphorus load and releases water with markedly reduced total phosphorus concentrations. Upstream reaches of the reservoir exhibit high algal production and reduced water clarity, due to ample availability of nutrients, whereas low algal production and increased water clarity are observed in downstream reaches coincident with declining nutrient availability.

Table Rock Lake, the next downstream reservoir in the cascade, benefits from phosphorus retention in Beaver Lake and receives inflows with relatively low total phosphorus concentrations. While release total phosphorus concentrations below Table Rock Lake are low, loading rates to the river are high immediately upstream from Bull Shoals Lake and total phosphorus concentrations are again elevated. However, the high rate of total phosphorus retention in Bull Shoals Lake (63%) again reduces total phosphorus concentrations in the White River below the dam. The net effect of the three-reservoir cascade is modulation of total phosphorus concentrations along this 200 km reach of the White River through phosphorus retention. In the absence of the three reservoirs, and given the occurrence of high rates of total phosphorus loading to the river, concentrations higher than those observed would be anticipated.

Kennedy (1999) reports that phosphorus retention by reservoirs is a function of water residence time and areal phosphorus loading rate (Figure 2), and that such retention has important implications for the phosphorus budgets of drainage basins. As demonstrated above for the White River, reservoirs can be viewed as nutrient sinks within a drainage basin and may serve to reduce loadings to downstream water resources, including other reservoirs. In the context of nutrient criteria, the value of this function for reservoirs should be a topic of discussion, since reservoirs identified as nutrient sinks may experience water quality conditions (e.g., high nutrient concentrations) that differ from those otherwise anticipated or desired. Nutrient criteria for such lakes could be modified accordingly.

*Figure 1: Average inflow and outflow total phosphorus concentrations (vertical bars) and in-reservoir total phosphorus concentration (solid circle) for Beaver, Table Rock, and Bull Shoals Lakes on the white River, AR.  $R_T$  and  $R_p$  indicate water residence time (days) and total phosphorus retention (percent), respectively.*

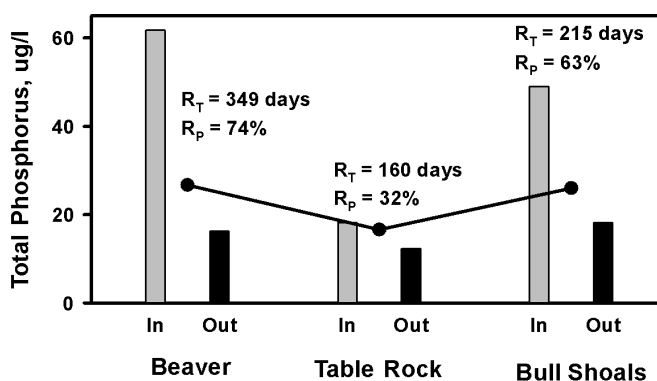
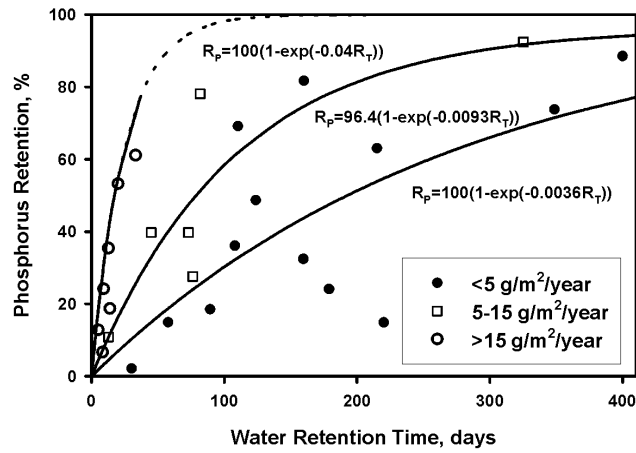



Figure 2: Relationship between total phosphorus retention and water residence time values for selected CE reservoirs with differing areal phosphorus loads. Curves and associated equations estimate relationships between total phosphorus retention (RP) and water residence time (RT) for each of three areal phosphorus loading categories (Kennedy 1999).



## CHAPTER 8

# Using Nutrient Criteria To Protect Water Quality

- A. State Water Quality Standards
- B. Water Quality–Based Approach to Pollution Control
- C. Nonpoint Source Pollution Control
- D. Comprehensive Nutrient Management
- E. Resources

This chapter provides an introduction to the applications of nutrient criteria. Chapter 1 described the uses of nutrient criteria as (1) identification of problems, (2) management planning, (3) regulatory assessments, (4) project evaluations, and (5) status and trend determination of the water resource. In this chapter, added discussion is provided for some of these uses of criteria. Sections A and B address regulatory assessments in the context of standards development and the water quality–based approach to pollution control, including development of a total maximum daily load (TMDL) and National Pollution Discharge Elimination System (NPDES) permits. Section C focuses exclusively on nonpoint source management programs. The chapter text ends with Section D, which addresses a comprehensive planning, application, and evaluation procedure for effective lake and reservoir nutrient quality management. Section E is a descriptive listing of some useful information resources associated with lake and watershed management.

### A. State Water Quality Standards

#### *1. Water Quality Standards and the Clean Water Act*

The goals of the Clean Water Act (CWA) are to achieve, wherever attainable, water quality that provides for protection and propagation of fish, shellfish, and wildlife and recreation in and on the water. The CWA further specifies that States adopt, and EPA review, standards consisting of designated uses and criteria based on those uses that serve the purpose of the CWA. EPA’s implementing regulations require States to specify designated uses for their waters and consideration of the goals of the CWA described above. Furthermore, States must adopt water quality criteria that protect the designated uses. Criteria must be based on sound scientific rationale and must contain sufficient parameters or constituents to protect the designated uses. For waters with multiple use designations, criteria must support the most sensitive use. Finally, in designating uses and establishing water quality criteria, States must ensure attainment of standards in downstream waters. With regard to nutrient criteria, Section 304(a) of the CWA directs EPA to develop and publish criteria that reflect the latest scientific knowledge of the effects of pollutants on biological community diversity, productivity, and stability, including information on the factors affecting rates of eutrophication for varying types of receiving waters. In its implementing regulation, EPA recommends that States adopt water quality criteria to protect designated uses based on Section 304(a) criteria, Section 304(a) criteria modified to reflect site-specific conditions, or criteria based on other scientifically defensible methods.

As illustrated in Figure 8.1, water quality standards for waters of the United States comprise designated uses, criteria to protect those uses, an antidegradation policy to maintain existing water quality, and implementation procedures for application to specific waters. Once water quality standards are adopted and approved, they become the basis for legally enforceable source control. Criteria as a component of standards are always established in the context of a designated use. Therefore, EPA, as well as States and Tribes, must develop criteria that are directly applicable to designated uses.

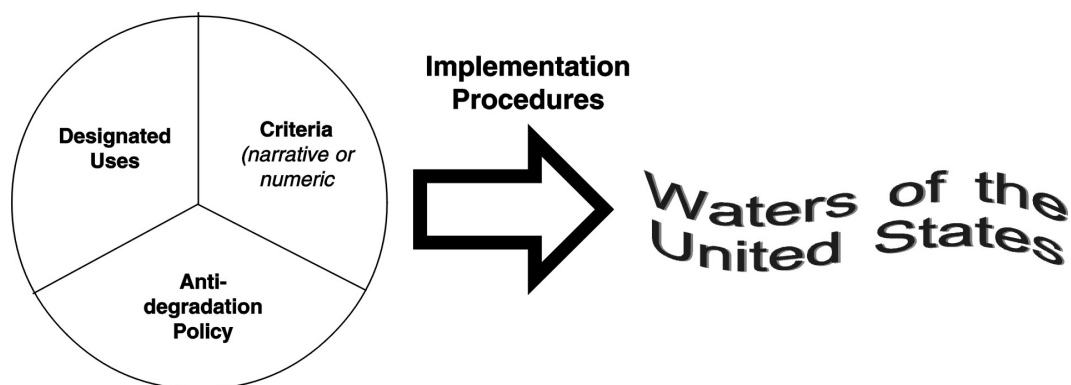

**Figure 8.1. Components of water quality standards.**

## ***2. Protecting Designated Uses***

It has been amply demonstrated that nutrients are a major contributor to use impairment in waters of the United States. Because States are required to designate uses in consideration of the goals of the CWA and adopt criteria that contain sufficient parameters or constituents to protect designated uses, and because it is EPA’s responsibility to provide recommended criteria, the Agency must develop and publish Section 304(a) criteria for nutrients that provide for protection and propagation of fish, shellfish, and wildlife and recreation in and on the water. Furthermore, EPA’s Section 304(a) criteria should reflect the effects on biological community diversity, productivity, and stability.

EPA’s Section 304(a) criteria will be issued on the basis of ecoregion and water body type. This approach to nutrient criteria development not only meets the above requirements but also provides a sound scientifically defensible approach that accounts for the characteristics of different types and locations of water bodies. EPA’s ecoregional nutrient criteria are intended to represent enrichment conditions of surface waters that are minimally impacted by human development activities, and will be developed and further refined based on the five elements described in this technical guidance manual. Water quality criteria incorporating minimally impacted (i.e., reference) conditions should provide for protection and propagation of aquatic life and recreation, and reflect conditions that will not adversely affect the biological community. Both causal variables (e.g., TN and TP) and response variables (e.g., turbidity and chlorophyll *a*) are necessary to provide sufficient protection of these uses before impairment occurs and to maintain downstream uses.

## ***3. Maintaining Existing Water Quality***

In addition to adopting sufficient criteria to protect designated uses for their waters, States and authorized Tribes must also adopt and implement an antidegradation policy to maintain existing uses and to maintain high water quality where it exists—regardless of the specified designated uses and associated criteria. State and Tribal antidegradation policies must be consistent with the Federal antidegradation policy as described at 40 CFR 131.12 to gain approval from EPA. Two key provisions of the Federal antidegradation policy are relevant to this discussion. The first requires that the level of water quality necessary to protect the existing uses must be maintained and protected (“Tier 1”). For a variety of reasons, an existing use may differ from the designated use, and may require either less stringent or more stringent protection than afforded by the criteria intended to protect the designated use.

The “Tier 2” provision is intended to provide protection for existing uses in cases where waters are not meeting their designated use, and also where the existing use happens to be better than the designated use. This second provision requires that existing high-quality waters (i.e., water quality that exceeds criteria to protect “fishable and swimmable” uses) must be maintained and protected unless it is demonstrated through a public process that a lowering of water quality is necessary to accommodate important economic or social development. In lowering water quality, the existing uses (Tier 1) must still be fully protected. “Tier 3” of the antidegradation policy preserves outstanding national resource waters, which is the highest level of protection under this policy.

As nutrient criteria are developed and adopted, it is important that States also review their antidegradation policy and associated implementation procedures. Antidegradation requirements are typically triggered when an activity is proposed that may have some effect on existing water quality. These requirements apply at a minimum to activities regulated under State, Tribal, or Federal law but can be more broadly applied. In practice, States and Tribes may encounter water where existing uses may not be protected by adopted criteria or existing high water quality exceeds adopted criteria. Antidegradation policies and procedures must ensure public participation in decisions affecting, for example, the impact on unique lakes of higher relative nutrient quality than might be stipulated in State or regional nutrient criteria based on a more extensive data set. States and Tribes should have effective antidegradation implementation procedures in place with criteria to ensure that existing water quality is maintained and protected from degradation by existing future point and nonpoint sources. Any State or local nonpoint source control requirements should be included in an antidegradation review.

#### ***4. Providing Flexibility in Implementation***

Abundant flexibility is built into the criteria setting process and water quality standard regulation to allow States to (1) develop their own criteria to protect specific uses or reflect more locally representative conditions, (2) use different techniques to develop criteria as long as they are protective and scientifically defensible, and (3) conduct use attainability studies and refine their use designation, where there is a conflict between designated uses and ecological criteria.

States also have the flexibility to adopt numeric criteria to protect designated uses or to adopt methods and procedures that translate narrative criteria to protect designated uses. Narrative criteria statements, often referred to as “general criteria” in States’ standards regulations, usually take the form of a description of desired water quality condition or a preclusion of certain types of pollution or undesirable conditions (i.e., the “free from” provisions).

Narrative criteria are considered to be critical backstops for designated use protection and are a powerful means of achieving desired water quality if they are interpreted in a clear and consistent manner. In water quality standards, a “translator” identifies a process, methodology, or guidance that States or Tribes will use to quantitatively interpret narrative criteria statements. Translators may consist of biological assessment methods (e.g., field measures of the biological community), biological monitoring methods (e.g., laboratory toxicity tests), models or formulate that uses input of site-specific information/data or other scientifically defensible methods. Translators are particularly useful for addressing water quality conditions that require a greater degree of sophistication to assess than can be typically expressed by numerical criteria that apply broadly to all waters with a given use designation. The translator may be either directly incorporated into State or Tribal water quality standards or incorporated by reference. In either case, specific limits or values for a measurable pollutant derived using a translator that interpret a narrative criterion statement should be attached to the State or Tribal regulations to ensure public review, as would be required of any site-specific numerical criterion.

The existing water quality standards regulation, along with the associated policies and national guidance, can provide the flexibility needed to accommodate appropriate adoption of nutrient criteria and subsequent implementation of control measures. The negative consequences of adopting inappropriate criteria include cases where the adopted criteria (and ensuing permit limits or other control measures) are not stringent enough and result in a loss of use, and cases where the adopted criteria are too stringent and lead to unnecessary source controls and increases to the list of impaired waters. In specific situations where criteria are thought to be overly protective, regulatory alternatives such as refined use designation, site-specific criteria, or a variance could be employed to ensure that the appropriate uses and criteria to protect the uses are established. For example, if a regulated source faces expensive treatment to comply with a new or revised requirement, the State or Tribe could seek a variance as described in 40 CFR 131.10(g) and determine if site-specific criteria are appropriate.

Specific situations where nutrient criteria are not sufficient to protect uses may be remedied through development of site-specific criteria, the need for which could be identified through an antidegradation review in situations involving high-quality water (i.e., nutrient concentrations below criteria levels). In situations where uses are not attained, the TMDL process is intended to improve water quality to meet the designated use. In situations involving high-quality water, new or expanded nutrient loads from a regulated source will probably trigger an antidegradation review. In addition to determining whether lowering water quality is necessary to accommodate important economic or social development, information generated through this review could be used to derive appropriate site-specific criteria to protect uses.

Water quality criteria published by EPA under Section 304(a) of the CWA such as criteria for nutrients serve as primary sources of information to States and Tribes as they develop numeric criteria as part of their State or Tribal water quality standards. Under the CWA and EPA's implementing regulations, States and Tribes may also use other information, including local water quality conditions, as they develop State or Tribal standards. In addition, EPA typically uses EPA's water quality criteria as the principal basis for proposing and promulgation of a replacement water quality standard where a State or Tribe fails to adopt an acceptable standard. Where a State or Tribe does not adopt scientifically defensible nutrient criteria to protect designated and existing uses, EPA will, as necessary, propose to promulgate Federal water quality standards for State or Tribal waters. In doing so, EPA commits to a process that includes public review and comment. EPA will solicit data information from the public to determine if such proposed Federal nutrient criteria for State waters are sufficiently protective of uses. This public process will help ensure that promulgated Federal water quality standards are neither too stringent nor overly permissive.

## **B. Water Quality–Based Approach to Pollution Control**

The water quality–based approach to watershed management emphasizes the overall quality of water within a watershed and provides a mechanism through which the amount of pollutant entering the water body is controlled based on the intrinsic conditions of the body of water and the standards set to protect it. A fundamental step in implementing the water quality–based approach is establishing procedures to assess attainment of water quality standards. With respect to nutrient criteria, States should identify and adopt, as appropriate, procedures for determining the attainment status that address factors such as:

- Monitoring strategy
- Spatial and temporal extent of sampling
- Frequency and duration of exceeding nutrient criteria parameters (e.g., TN, TP, chlorophyll *a*, algal turbidity)

- Minimum number of samples required
- Averaging period for combining samples to compare to nutrient criteria parameters.

Additional discussion of parameters to sample, sampling frequency, and sampling locations is provided in sections B.3 and B.10 of this chapter. These procedures should lend themselves to be reproducible, apply consistently to the waters where the criteria are assigned to protect the designated use, and provide clear answers to the following questions:

- What parameters do I monitor?
- Where and when do I sample?
- How do I evaluate the results?

The information below summarizes how the different programs fit into an overall water quality control scheme and is not intended as specific implementation guidance. Implementation of a program should be consistent with the specific programmatic regulations and guidance documents provided by the program office.

### ***Step 1: Identification of Impaired and Threatened Waters***

Step 1 of the water quality–based approach to watershed management encompasses two CWA requirements: 305(b) reporting and development of a 303(d) list. Both of these activities are separate CWA elements and EPA programs. They are cited here to illustrate their application to components of a comprehensive coordinated EPA effort to improve the Nation’s water quality.

#### **■ 305(b) Water Quality Inventory**

The CWA establishes a process for States to develop information on the quality of the Nation’s water resources in Sections 106(e), 204(a), 303(d), 305(b), and 314(a). Under Section 305(b), each State or Tribe must develop a program to monitor the quality of its surface and ground waters. The primary purpose of the State monitoring program is to evaluate attainment with water quality standards. Section 305(b) requires States to provide EPA with a report describing the status of water quality every 2 years.

Lake water quality assessment is an integral part of a State 305(b) report. States should report summary statistics for use support and for causes and sources of impairment of lakes as described in the most recent *Guidelines for Preparation of the Comprehensive State Water Quality Assessments (305(b) Reports) and Electronic Updates*. For all assessed lakes, States are required to include statistics on the degree of use support (fully supporting, threatened, or impaired), the degree of use support organized by use (e.g., aquatic life, swimming), and the total size of waters impaired by various source categories (e.g., industrial point sources, silviculture).

The role of nutrient criteria in the 305(b) process is that nutrient criteria establish the benchmark used to judge the degree of use support and are, therefore, an integral part of the assessment and 305(b) reporting process. In particular, for significant publicly owned lakes, each State should include in its 305(b) report a discussion of State water quality standards as they apply to lakes. Nutrient criteria that have been adopted into State water quality standards are an important component of this discussion. If nutrient criteria have been developed, but have not yet been adopted into State water quality standards, they could still be utilized to classify the trophic status of the lake and discussed in the context of a measure used to determine lake status, rather than as a water quality standard (see CWA Section 314(a)(1)(E)).

## ■ Section 303(d) Lists

Section 303(d)(1)(A) of the CWA established the requirement for the development of Section 303(d) lists of impaired waters. The Section 303(d) list is a prioritized list of water quality limited waters and identifies waters needing TMDLs. States prepare their 303(d) lists using the information contained in their 305(b) reports, as well as other existing and readily available sources of water quality information. States, Territories, and authorized Tribes must submit their 303(d) lists to EPA for review and approval. If EPA disapproves a Section 303(d) list, then EPA will establish a Section 303(d) list for them.

### *Step 2: Priority Ranking and Targeting*

Once water bodies needing TMDLs have been identified on the 303(d) list, a State, Territory, or authorized Tribe should prioritize those water bodies using established ranking procedures that consider all water pollution control activities within the State, Territory, or lands of the authorized Tribe. The CWA states that the “State shall establish a priority ranking for such waters.” The goal of priority ranking is to focus attention on the right water bodies at the right time, while enabling a State, Territory, or authorized Tribe to make efficient use of its available resources and meet the objectives of the CWA.

In addition to priority ranking the waters on the 303(d) list, States, Territories, and authorized Tribes must develop a schedule for establishing TMDLs. The schedule is not intended to rigidly constrain the process of establishing TMDLs and should be considered an opportunity to explain how TMDLs will be completed. When synchronized with the broader planning process of a State, Territory, or authorized Tribe, the schedule can be the basis for a practical plan for managing and completing the required TMDLs.

### *Step 3: Development of TMDLs*

TMDLs are written plans and analyses established to ensure that the water bodies will attain and maintain water quality standards. The TMDL process is an essential element of the water quality–based approach to watershed management. It links development and implementation of control measures to attainment of water quality standards. Through establishment and implementation of a TMDL, pollutant loadings from all sources are estimated, links are established between pollutants and sources, and appropriate control mechanisms can be established or modified so that water quality standards can be achieved.

Successful use of the TMDL process to develop an effective strategy to improve water quality requires accurately defining the problem, characterizing the impaired water body and all pollutants contributing to the impairment, and understanding the political and economic constraints that affect implementation and acceptance of the TMDL. Establishment of TMDLs rests on the following premises:

- The total pollutant load to a water body is derived from point, nonpoint, and background sources.
- Pollutant loads can be transported into a water body directly through effluent discharge, bank and bar erosion (in streams, river, estuaries, and lakes), recirculation (e.g., nutrients in lakes, estuaries, and wetlands), solar heating, atmospheric deposition, and ground water flows or indirectly by overland flow caused by snowmelt or precipitation.

- The technical approach used to develop the TMDL will vary according to the nature of the problem, pollutant of concern, type of water body, types and number of pollutant sources, and political and economic constraints that affect a specific watershed.

An essential step in developing a TMDL is determining the water body target for the pollutant of concern. From a broad management perspective, the purpose of target analysis is to define the relationship between designated uses, numeric measure(s) of success, and pollutant. The primary goals of target analysis are to (1) clarify whether the ultimate objective of the TMDL is to comply with a numeric water quality criterion, comply with an interpretation of a narrative water quality criterion, or attain a desired condition that supports meeting a specified designated use; (2) identify the water body's critical conditions; (3) identify appropriate ways to measure progress toward achieving stated goals; and (4) tie the measures to pollutant loading.

The criteria development process described in this guidance manual provides the necessary information to complete the target analysis component of a TMDL.

#### ***Step 4: Implementation of Controls***

TMDLs are required to consider the effects of processes that contribute pollutants to a water body. These processes may relate to thermal discharges, critical flow conditions, sedimentation, and riparian and channel processes. Control measures to implement TMDLs, therefore, are not limited to NPDES permits, but also may include State, Territorial, Tribal, and local authorities and actions to reduce nonpoint source pollution.

#### **■ NPDES Permits**

The CWA requires waste water dischargers to have a permit establishing pollution limits, and specifying monitoring and reporting requirements. More than 200,000 sources are regulated by NPDES permits nationwide. NPDES permits regulate household and industrial wastes that are collected in sewers and treated at municipal waste water treatment plants. Permits also regulate industrial point sources and concentrated animal feeding operations that discharge into other waste water collection systems, or that have the potential to discharge directly into receiving waters. Permits regulate discharges with the goals of (1) protecting public health and aquatic life and (2) ensuring that every facility treats waste water. Typical pollutants regulated by NPDES are “conventional pollutants” such as fecal coliforms or oil and grease from the sanitary wastes of households, businesses, and industries, and “toxic pollutants” including pesticides, solvents, polychlorinated biphenyls, dioxins, and heavy metals that are particularly harmful to animal or plant life. “Nonconventional pollutants” are any additional substances that are not conventional or toxic that may require regulation, including nutrients such as nitrogen and phosphorus.

Discharge monitoring data for pollutants limited and/or monitored pursuant to NPDES permits issued by States, Tribes, or EPA are required to be stored in the central EPA Permit Compliance System (PCS). Assessment of point source loadings is not a simple process of assessing PCS data, even though PCS is an important data source. The PCS database does not provide complete information for important nitrogen sources. Most PCS nitrogen data are generated by water quality–based permit limitations on ammonia, often applied in discharges to smaller streams. Few data exist in PCS on other forms of nitrogen, or TN; and data for TP are not frequently found in PCS. This situation exists largely because most permits do not include limits and/or monitoring requirements for nitrogen or phosphorus. The lack



of nutrient limits and/or monitoring requirements in permits is due to a general lack of State water quality standards for these parameters.

### ■ NPDES Storm Water Permitting Program

Storm water runoff is one of the remaining causes of contaminated lakes, streams, rivers, and estuaries throughout the country. Pollution in storm water runoff is responsible for closing beaches and shellfish harvesting areas, contaminating fish, and reducing populations of water plants and other aquatic life. High flows of storm water runoff cause flooding, property damage, erosion, and heavy siltation. The CWA requires EPA and States/Tribes to implement a national storm water control program to correct these problems. NPDES permits are currently required for storm water discharges from municipal separate storm sewer systems (MS4s) serving populations over 100,000, certain categories of industrial activities, and construction activity disturbing more than 5 acres. Revisions to the storm water regulations published December 8, 1999 (64 CFR 68722), will expand permit requirements to MS4s in urbanized areas serving populations under 100,000 and construction activity disturbing 1 to 5 acres.

### ■ Nonpoint Source Pollution

Under Section 319 of the CWA, States (*and Territories and approved Tribes*) address nonpoint source pollution by assessing nonpoint pollution problems and sources within the State, adopting management programs to control the nonpoint sources, and implementing the management programs. These programs may contain a variety of voluntary and regulatory approaches to controlling nonpoint source pollution. Section 319 also authorizes EPA to issue grants to the States to assist them in implementing EPA-approved nonpoint source management programs. Since 1990, EPA has issued \$1 billion in nonpoint source management grants to States, Territories, and Tribes. In fiscal year 2000, Congress appropriated \$200 million for the implementation of State programs.

The Coastal Zone Act Reauthorization Amendments of 1990 (CZARA) required States with approved Coastal Zone Management Programs to develop and submit coastal nonpoint pollution control programs to EPA and the National Oceanic and Atmospheric Administration (NOAA) for approval. These State programs must include enforceable policies and mechanisms to ensure implementation of management measures for the control of nonpoint source pollution to restore and protect coastal waters. At their discretion, States may elect to include freshwater areas in their nonpoint pollution control programs. Section D of this chapter provides additional detail on nonpoint source pollution management programs.

### ***Step 5: Assessment of Controls***

Followup monitoring is an important step in the water quality-based approach. The following are among the key factors to consider when developing a followup monitoring plan:

- *Need to evaluate TMDL components.* TMDL problem identification, indicators, numeric targets, source estimates, and allocations might need reevaluation to determine whether they are accurate and effective.
- *Need to evaluate implementation actions.* It is often important to determine whether actions needed to achieve loading allocation were actually carried out and whether these actions were effective in achieving the allocations.

- *Stakeholder goals for monitoring efforts.* Watershed stakeholders often participate in followup monitoring, and their interests should be considered.
- *Existing monitoring activities, resources, and capabilities.* Analysts should identify existing and planned monitoring activities to address followup monitoring needs in concert with these efforts, particularly where a long-term monitoring program is envisioned, the study area is large, or water quality agency monitoring resources are limited. Staff capabilities and training also should be considered to ensure that monitoring plans are feasible.
- *Practical constraints to monitoring.* Monitoring options can be limited by practical constraints, such as problems with access to monitoring sites and concerns about indirect impacts of monitoring on habitat.

The role of nutrient criteria in followup monitoring is as follows:

- Nutrient criteria will provide the measure of success for controls.
- Process may need to be revisited if followup monitoring and reference condition calibration indicate criteria should be revised.
- Process may need to be revisited if followup monitoring indicates designated uses should be revised.

### **C. Nonpoint Source Pollution Management**

Nonpoint source pollution generally results from land runoff, precipitation, atmospheric deposition, drainage, seepage, or hydrologic modification. Technically, the term "nonpoint source" is defined to mean any source of water pollution that does not meet the legal definition of "point source" in section 502(14) of the CWA. That definition states:

The term "point source" means any discernible, confined and discrete conveyance, including but not limited to any pipe, ditch, channel, tunnel, conduit, well, discrete fissure, container, rolling stock, concentrated animal feeding operation, or vessel or other floating craft, from which pollutants are or may be discharged. This term does not include agricultural storm water discharges and return flows from irrigated agriculture.

Although diffuse runoff is generally treated as nonpoint source pollution, runoff that enters and is discharged from conveyances such as those described above is treated as a point source discharge and hence is subject to the permit requirements of the CWA. In contrast, nonpoint sources are not subject to Federal permit requirements.

Nonpoint pollution is the pollution of our Nation's waters caused by rainfall or snowmelt moving over and through the ground. As the runoff moves, it picks up and carries away natural pollutants and pollutants resulting from human activity, finally depositing them into lakes, rivers, wetlands, coastal waters, and ground waters. In addition, hydrologic modification is a form of nonpoint source pollution that often adversely affects the biological and physical integrity of surface waters. A more detailed discussion of the range of nonpoint sources and their effects on water quality and riparian habitats is provided in subsequent chapters of this guidance.

## ***1. Guidance for Controlling Nonpoint Sources of Nutrients***

*Guidance Specifying Management Measures for Sources of Nonpoint Pollution in Coastal Waters* (EPA, 1993) was developed by EPA for the planning and implementation of Coastal Nonpoint Pollution Programs. The guidance focuses on controlling five major categories of nonpoint sources that impair or threaten waters nationally, and provides useful guidance for nonpoint source pollution management in both coastal and noncoastal areas. Management measures are specified for (1) agricultural runoff, (2) urban runoff (including developing and developed areas), (3) silvicultural (forestry) runoff, (4) marinas and recreational boating, and (5) channelization and channel modification, dams, and streambank and shoreline erosion. EPA also includes management measures for wetlands, riparian areas, and vegetated treatment systems that apply generally to various categories of sources of nonpoint pollution. Management measures are defined in the CZARA as economically achievable measures to control the addition of pollutants to waters, which reflect the greatest degree of pollutant reduction achievable through the application of the best available nonpoint pollution control practices, technologies, processes, siting criteria, operating methods, or other alternatives.

The following section outlines some of the management measures specified in the CZARA guidance for the various types of nonpoint sources. These measures should be considered when implementing programs targeting nutrient releases into waters of the U.S. Information on specific management practices is available in *Guidance Specifying Management Measures for Sources of Nonpoint Pollution in Coastal Waters* (EPA, 1993).

### **■ Agricultural Runoff**

- Erosion and sediment control
- Control of facility waste water and runoff from confined animal facilities
- Nutrient management planning on cropland
- Grazing management systems
- Irrigation water management

### **■ Urban Runoff**

- Control of runoff and erosion from existing and developing areas
- Construction site runoff and erosion control
- Construction site chemical control (includes fertilizers)
- Proper design, location, installation, operation, and maintenance of onsite disposal systems
- Pollution prevention education (e.g., household chemicals, lawn and garden activities, golf courses, pet waste, onsite disposal systems)
- Planning, siting, and developing roads, highways, and bridges (including runoff management)

### **■ Silvicultural Runoff**

- Streamside management
- Road construction and management
- Forest chemical management (includes fertilizers)
- Revegetation
- Preharvest planning, harvesting management

## ■ **Marinas and Recreational Boating**

- Sting and design
- Operation and maintenance
- Storm water runoff management
- Sewage facility management
- Fish waste management
- Pollution prevention education (e.g., proper boat cleaning, fish waste disposal, and sewage pump out procedures)

## ■ **Hydromodification** (i.e., channelization, channel modification, dams)

- Minimize changes in sediment supply and pollutant delivery rates through careful planning and design
- Erosion and sediment control
- Chemical and pollutant control (includes nutrients)
- Stabilization and protection of eroding streambanks or shorelines

## ■ **Wetlands, Riparian Areas, Vegetated Treatment Systems**

- Protect the NPS abatement and other functions of wetlands and riparian areas through vegetative composition and cover, hydrology of surface and ground water, geochemistry of the substrate, and species composition
- Promote restoration of preexisting function of damaged and destroyed wetlands and riparian systems
- Promote the use of engineered vegetated treatment systems where they can serve a NPS pollution abatement function

## **2. *Nonpoint Source Management Programs***

In 1987, in view of the progress achieved in controlling point sources and the growing national awareness of the increasingly dominant influence of nonpoint source pollution on water quality, Congress amended the CWA focus greater national efforts on nonpoint sources. In the Water Quality Act of 1987, Congress amended Section 101, “Declaration of Goals and Policy,” to add the following fundamental principle:

It is the national policy that programs for the control of nonpoint sources of pollution be developed and implemented in an expeditious manner so as to enable the goals of this Act to be met through the control of both point and nonpoint sources of pollution.

More importantly, Congress enacted Section 319 of the CWA, which established a national program to control nonpoint sources of water pollution. Under Section 319, States address nonpoint pollution by assessing nonpoint source pollution problems and causes within the State, adopting management programs to control the nonpoint source pollution, and implementing the management programs. Although not required, many States have incorporated the management measures specified in the 1993 CZARA guidance into their State Nonpoint Source Management Programs.

Section 319 also authorizes EPA to issue grants to States to assist them in implementing those management programs or portions of management programs that have been approved by EPA. Since 1990, \$876.5 million dollars in grants have been given to States, Territories, and Tribes for implementation of nonpoint source pollution control programs.

For additional information on the Nonpoint Source Management Program and distribution of Section 319 grants in your State, contact your State’s designated nonpoint source agency. For many states, the nonpoint source agency is the State Water Quality Agency. However, in several instances, other agencies or departments are given nonpoint source responsibility (see Table 8.1).

**Table 8.1. States for Which the Nonpoint Source Agency Is Not the Water Quality Agency**

<b>State</b>	<b>State Nonpoint Source Agency</b>
Arkansas	State Department of Soil and Water Conservation
Delaware	State Department of Soil and Water Conservation
Oklahoma	State Department of Soil and Water Conservation
Pennsylvania	State Department of Soil and Water Conservation
Tennessee	State Department of Agriculture
Texas	Department of Soil and Water Conservation (for agriculture) Texas Water Quality Board (all other nonpoint sources)
Virginia	State Department of Soil and Water Conservation

### **3. Coastal Nonpoint Pollution Control Programs**

In November 1990, Congress enacted the CZARA. These amendments were intended to address several concerns, a major one of which is the impact of nonpoint source pollution on coastal waters.

To address more specifically the impacts of nonpoint source pollution on coastal water quality, Congress enacted Section 6217, “Protecting Coastal Waters,” which was codified as 16 USC-1455b. This section provides that each State with an approved coastal zone management program must develop and submit to EPA and the NOAA for approval a Coastal Nonpoint Pollution Control Program. The purpose of the program “shall be to develop and implement management measures for nonpoint source pollution to restore and protect coastal waters, working in close conjunction with other State and local authorities.” States determine how far “upstream” their coastal zone management program applies; in some instances, the entire State is covered in a comprehensive attempt to merge coastal zone management and nonpoint source pollution management.

States and Territories with Coast Nonpoint Pollution Control Programs may elect to implement alternative management measures as long as the alternative measures will achieve the same environmental results as those described in the 1993 CZARA guidance, as discussed previously. A listing of States with Coastal Nonpoint Pollution Control Programs is presented in Table 8.2. For additional information on the programs in these States, contact the State water quality agency.

**Table 8.2. States and Territories with Coastal Nonpoint Pollution Control Programs**

Alabama	Maine	Oregon
Alaska	Maryland	Pennsylvania
American Samoa	Massachusetts	Puerto Rico
California	Michigan	Rhode Island
Connecticut	Mississippi	South Carolina
Delaware	New Hampshire	Virgin Islands
Florida	New Jersey	Virginia
Guam	New York	Washington
Hawaii	North Carolina	Wisconsin
Louisiana	Northern Mariana Islands	

**4. Farm Bill Conservation Provisions**

Technical and financial assistance for landowners seeking to preserve soil and other natural resources is authorized by the Federal Government under provisions of the Food Security Act (Farm Bill). Provisions of the 1996 Farm Bill relating directly to installation and maintenance of BMPs are summarized in the following sections. For State-specific information, contact your NRCS State Conservationist’s office.

■ **Environmental Conservation Acreage Reserve Program (ECARP)**

ECARP is an umbrella program established by the 1996 Farm Bill that contains the Conservation Reserve Program (CRP), Wetlands Reserve Program (WRP), and Environmental Quality Incentives Program (EQIP). It authorizes the Secretary of Agriculture to designate watersheds, multi-State areas, or regions of special environmental sensitivity as conservation priority areas that are eligible for enhanced Federal assistance. Assistance in priority areas is to be used to help agricultural producers comply with NPS pollution requirements of the CWA and other State or Federal environmental laws. The ECARP is authorized through 2002.

■ **Conservation Reserve Program (CRP)**

First authorized by the Food Security Act of 1985 (Farm Bill), this voluntary program offers annual rental payments, incentive payments, and cost-share assistance for establishing long-term, resource-conserving cover crops on highly erodible land. CRP contracts are issued for a duration of 10 to 15 years for up to 36.4 million acres of cropland and marginal pasture. Land can be accepted into the CRP through a competitive bidding process where all offers are ranked using an environmental benefits index, or through continuous sign-up for eligible lands where certain special conservation practices will be implemented.

The Conservation Reserve Enhancement Program (CREP) is a new initiative of CRP authorized under the 1996 Federal Agricultural Improvement and Reform Act. CREP is a joint, State–Federal program designed to meet specific conservation objectives. CREP targets State and Federal funds to achieve shared environmental goals of national and State significance. The program uses financial incentives to encourage farmers and ranchers to voluntarily protect soil, water, and wildlife resources.

#### ■ **Wetlands Reserve Program (WRP)**

The WRP is a voluntary program to restore and protect wetlands and associated lands. Participants may sell a permanent or 30-year conservation easement or enter into a 10-year cost-share agreement with USDA to restore and protect wetlands. The landowner voluntarily limits future use of the land, yet retains private ownership. The Natural Resources Conservation Service (NRCS) provides technical assistance in developing a plan for restoration and maintenance of the land. The landowner retains the right to control access to the land and may lease the land for hunting, fishing, and other undeveloped recreational activities.

#### ■ **Environmental Quality Incentives Program (EQIP)**

The EQIP was established by the 1996 Farm Bill to provide a voluntary conservation program for farmers and ranchers who face serious threats to soil, water, and related natural resources. EQIP offers financial, technical, and educational help to install or implement structural, vegetative, and management practices designed to conserve soil and other natural resource. Current priorities for these funds dictate that one half of the available monies be directed to livestock-related concerns. Cost-sharing may pay up to 75% of the costs for certain conservation practices. Incentive payments may be made to encourage producers to perform land management practices such as nutrient management, manure management, integrated pest management, irrigation water management, and wildlife habitat management.

#### ■ **Wildlife Habitat Incentives Program (WHIP)**

This program is designed for people who want to develop and improve wildlife habitat on private lands. Plans are developed in consultation with NRCS and local Conservation District. USDA will provide technical assistance and cost-share up to 75% of the cost of installing the wildlife practices. Participants generally must sign a 5- to 10-year contract with the U.S. Department of Agriculture (USDA), which requires that they maintain the practices.

#### ■ **Forestry Incentives Program (FIP)**

Originally authorized in 1978, the FIP allows cost sharing up to 65% (up to a maximum of \$10,000 per person per year) for tree planting, timber stand improvement, and related practices on nonindustrial private forest land. The FIP is administered by NRCS and the U.S. Forest Service. Cost share funds are restricted to individuals who own no more than 1,000 acres of eligible forest land.

#### ■ **Conservation of Private Grazing Land**

This program was authorized by the 1996 Farm Bill for the purpose of providing technical and educational assistance to owners of private grazing lands. It offers opportunities for better land management, erosion reduction, water conservation, wildlife habitat, and improving soil structure.

## **D. A Comprehensive Procedure for Nutrient Management**

In addition to regulatory assessment and source control, criteria can serve as effective scientific tools for holistic resource management. Effective programs incorporate aspects of prevention and maintenance as well as restoration. It is important that existing high-quality waters be managed wisely as a public resource and that waters whose uses are not yet threatened or impaired, but nonetheless are at risk from ongoing pollution, are identified and managed such that beneficial uses are maintained in the future. Below is a generic 10-step management program that originated with the Wisconsin Inland Lakes Program (Gibson et al., 1983) and has been subsequently refined as a natural resources management approach. States and Tribes can use this procedure in addition to their established regulatory protocols. This approach is intended to illuminate useful steps to take to ensure responsive management; it is not intended to establish or mandate any procedures as part of a regulatory requirement.

Management of lakes and reservoirs may be approached in a rational progression of actions beginning with a statement of their major stressors and symptoms and progressing logically to a course of action and final assessment to determine the relative success of the effort. The following sequence of steps is one illustration of this management approach. States or communities are encouraged to adapt this technique to suit their particular needs and expectations. Where considerable information is already available, some of these steps may be unnecessary, but the methodology is presented here for consideration.

### ***1. Status Identification***

Data used during the preliminary nutrient criteria development process and the application of the criteria will present the resource manager with an image of the general status of a lake/reservoir and the degree of need for responsive action. The information associated with these efforts, however, usually indicates a broad status condition, for example, high nutrient concentrations, algal blooms, fish kills, or low dissolved oxygen. Available data should be evaluated carefully to tease out potential relationships with land use practices or recent changes in practices (e.g., fishing pressure, stocking or lack thereof). In particular, previous investigations should be reviewed to make a preliminary determination of anthropogenic cause(s) versus natural cycling of the lake or reservoir. Essentially, one needs to conduct a preliminary evaluation of readily available or on-hand lake or reservoir data to ascertain that there is indeed a problem or potential problem of cultural overenrichment and that these sources probably can be addressed to the betterment of the water body and the public good.

### ***2. Background Investigation***

Given that the initial information reveals a viable management concern, it then becomes necessary and justifiable to gather as much background information as possible about the water body in question. There are three primary sources of such information.

#### **■ Literature Searches**

The initial effort here should be the “gray literature” (often internal regional State and Federal agency reports that provide specific information about that lake). Sources of such information include natural resource and fisheries agencies, forestry services, water quality administrations, hydrological and geological survey offices, planning offices, multi-State or county commissions, and community or environmental groups. A second source would be peer-reviewed professional literature—journals and related publications such as proceedings of conferences and symposiums, which may include specific



studies of the lake or reservoir of concern. But their primary value probably will be discussions of methods and techniques of investigation and management. As the management investigation progresses, these sources of information become more pertinent.

## ■ Questionnaires

In preparing a list of agencies from which reports may be solicited, the names of key personal contacts also should evolve. These contacts are the biologists, chemists, specialists, academics and resource managers, and citizen activists most familiar with the lake(s) of concern. As the literature and baseline data are reviewed, particular questions should develop, the answers to which will provide a fuller understanding of the resource and lend direction to the investigation and eventual management plan. Particularly helpful will be an understanding of the historical antecedents of the present status of the lake or reservoir.

A standardized questionnaire can be prepared listing concerns such as the availability of any reports or data or understanding of the history of development in the watershed, perhaps including industries, agricultural practices, or development and structures associated with the lake. Particular episodes may be noted for comment in the questionnaire, such as fish kills, algal blooms, or spill events, as well as historical problems, such as septic tank problems, agricultural runoff, erosion problems, or development concentrations.

All discharge sites should be documented, such as waste water treatment plants, drains, concentrations of cottages with onsite waste water treatment, marinas, major road crossings, and tributaries potentially bearing loadings of sediments or nutrients. Problem land use areas along the shore also should be noted, for example, degraded wetlands, lobes of the lake or reservoir where blooms or fish kills regularly occur, or areas where aquatic macrophytes have recently expanded or contracted. In addition, it is helpful to include a large, fairly detailed line drawing of the lake/reservoir and its watershed that the respondent may use to locate and identify particular observations.

If at all possible, the questionnaire should be limited to no more than two pages of questions, including space for answers plus the line drawing. Questions should be direct and concise. Determine exactly what you wish to learn and ask questions specifically related to this information. Opportunities for additional comments should be restricted to one open question at the end of the questionnaire.

To get the best response to a questionnaire, the potential respondents should be called first to confirm the names on the mailing list. They should be advised of the nature of the study and their cooperation then requested. Other potential respondents may be identified through these calls. If a large survey is necessary, this preliminary step may not be possible. However, most such regional inquiries are usually to no more than 50 specialists, and the additional information gained is well worth the telephone calls.

## ■ Interviews

By this point in the background investigation process, the key people to contact for detailed information should be evident. Their names will have come up in conversations and on reports, and they will be the people providing the most helpful responses on the questionnaires.

Other valuable contacts are the USDA Cooperative Extension Service agents for the counties in which the lake/reservoir is situated, county planners, and long-term residents and fishermen of the area. Their anecdotal information can be invaluable and helps add perspective to other sources of data.

The basis for the interviews should be to assess the questionnaire data already gathered. The interviews should clarify and elaborate on basic information generated by the questionnaire. The interview is also the means by which apparent contradictions in perceptions or observations may be at least partially resolved. It should be noted that many people are uncomfortable with recorded interviews; note-taking is often a more complimentary and less intimidating way to record information. In any case, immediately after each interview, a record of answers and observations should be prepared while the impressions of the interview are still fresh.

The compiled information from the background investigation will further clarify the initial problem statement. It should help resolve any ambiguities about the dynamics of the lake/reservoir and the human community. In addition, it should clearly define areas where more definitive, primary data collection is required to clearly understand the nutrient problems of that particular water body and provide direction for the subsequent management project.

### ***3. Data Gathering and Diagnostic Monitoring***

Data obtained during the nutrient criteria development process is the mainstay of the database to be prepared for any subsequent investigation. The intent of that survey was to develop a reasonable image of the status of the lake/reservoir. Diagnostic monitoring should expand on that structure and extend the understanding from status of the resource to a diagnosis of causes of the overenrichment. For example, where three reaches of a lake/reservoir may have been sampled and two identified as being of concern, now the tributaries and other higher order streams must be sampled to further reduce the area to locations of probable loadings. While earlier sampling was to portray the trophic state of the lake or reservoir, these sample sites should be directed specifically toward near-shore areas of potential loadings, tributaries, and portions of the tributaries where loadings may originate.

Diagnostic monitoring supports the identification of water quality problems and helps to develop an appropriate management plan. General guidelines for conducting diagnostic monitoring are provided below.

#### **■ Parameters To Sample**

Diagnostic monitoring is conducted after nutrient criteria have been established. It might not be necessary, therefore, to sample some parameters that are not related to the criteria.

Diagnostic sampling for nutrients requires an estimation of nutrient loading and sources. Major potential sources of nutrients (e.g., tributary streams, ground water flow, runoff, illegal discharges, atmospheric deposition) should be identified and sampled in such a way as to obtain an estimate of annual loads from each source. For methods and design considerations, see Olem and Flock (1990) and Wedepohl et al. (1990).

The variables and techniques employed in the preliminary survey should be reviewed for adequacy and either repeated or augmented. The manager should not eliminate the basis of the original classification by dropping any variables or stations at this point. Documenting potential success or failure of the subsequent management program will require “before” and “after” databases, and the initial survey design should be modified only after careful consideration and due attention to reestablishing the baseline survey.

Flow measurements are also an essential part of this survey. If nutrient concentrations are to be meaningfully compared and loading estimates made, cross-sectional areas and flow rates for all tributary streams and discharges must be included in the survey design. These measurements must be made or extrapolated each time water quality samples are collected. Without this information, it will be difficult or impossible to assign priorities to various loading sources identified in the investigation.

### ■ Sampling Frequency

Sampling frequency will increase for diagnostic monitoring because the sample population is now an individual lake. Sampling should occur repeatedly during the growing season to be able to precisely characterize individual lakes as well as discharges and loadings. Statistical power analysis can be used to determine the appropriate sample size based on the purpose of the sampling and the acceptable error (see Chapter 9).

In addition to expanding the number of stations and parameters to accommodate diagnostic determinations, the survey design should address the temporal variable by sampling these stations during each season of the year at times calibrated to that particular climate and locale. Accommodation may need to be made for periods of base flow, maximum runoff, turnovers, periods of maximum and minimum productivity, and, in some instances, migratory patterns of fish or waterfowl. Seasonal changes in land use such as peak summer or winter vacation periods, agricultural applications and harvests in the watershed, and seasonal commercial or industrial activities also should be addressed.

To separate signals from seasonal noise, it may be necessary to gather survey data for 2 or more consecutive years to strengthen data assessments. Such assessments will require a robust statistical evaluation of the data; this element should be incorporated into the study design at the outset. As with the initial survey design, the preliminary statistical tools chosen may be carried into this subsequent design as well. Care should be taken to address the need for replicate sample collections to ensure representative sample design and confidence in the results to be obtained. Early inclusion of a skilled environmental statistician on the management team is advisable.

### ■ Sampling Location

If turbidity, nutrients, and algae are known to be variable across the surface of a lake, then multiple sample sites are required. If gradients are known to occur, as in many large reservoirs, then sampling should be stratified by zones. For example, in a reservoir one could define the three reservoir zones (riverine, transitional, lacustrine) as sampling strata and take two or more samples from each zone.

The exact number of sampling sites in a lake or lake zone is determined by the spatial variability of nutrients, turbidity, and chlorophyll and the desired precision. In general, within a basin or reservoir zone, variation in time is larger than variation in space (Knowlton and Jones, 1989). Thus, chlorophyll samples taken 2 weeks apart may differ by severalfold, but samples taken on the same day 500 meters apart are likely to differ much less. Depending on the questions being addressed in the investigation, spatially composite samples may be more cost-effective than separate samples from several sites in a lake (see Olem and Flock [1990] and Wedepohl et al. [1990]).

The design and placement of these sample stations will rely heavily on the land use information developed from the background investigation. The overall premise should be to bracket suspected sources of nutrient loadings in the tributaries and near-bank areas so parcels can be either selected or eliminated as potential candidates for management attention.

#### ***4. Source Identification***

The cumulative information gathered should now provide a clear image of the state of the lake or reservoir, the most likely sources of nutrient loadings or related degradation, and their relative contributions to the problem. It is important to note that this process reveals only local sources of the overenrichment. Atmospheric deposition of nitrogen compounds and other broad-scale impacts beyond the watershed scale are not specifically addressed and must be assumed as essentially an environmental constant. With all the risks this entails, it is probably not an undue assumption, because such remediation is probably beyond the scope of most nutrient management projects employing this guidance.

The problems to be identified are likely to be as diverse as the geology, hydrology, and land use practices of the lake/reservoir and watershed. Typical elements include sediment resuspension and nutrient re-release; biotic imbalances affecting nutrient utilization by overfishing or stock mismanagement; discharge of excess nutrients directly to the lake or reservoir by waste water treatment plants, storm water runoff, or failing septic systems; and runoff from subdivisions, farms, logging operations, golf courses, and shopping centers. Other problems have included concentrations of migratory and resident waterfowl contributing to an excess of nutrients, removal or filling of bank areas and wetlands that once intercepted nutrient runoff, herbicide applications that killed macrophytes and promoted nuisance algal blooms, and chronic low dissolved oxygen problems attendant to overenrichment and vegetative imbalances.

Any combination of these in situ and land use problems are potential causes of the cumulative overenrichment problem. Management planning requires identifying first the loading sources and, second, of those sources, the ones that are most significant. Proximity of a source to the lake or reservoir (or in some cases, the ubiquitous nature of a source throughout the watershed such as subdivision or farm runoff), the relative loading estimate of that source, and the likelihood of successful remediation are the key factors in deciding which problem sources are priorities for inclusion in a management plan.

Loading estimation models such as those developed by Vollenweider and by Dillon and Rigler, the Reckhow-Simpson model, and BATHTUB by Walker are valuable for estimating the relative significance of various nutrient sources in the watershed with respect to the likely response of the lake. Chapter 9 describes many of these models and their relative utility. Modeling permits the manager to try out various preliminary management scenarios and combinations of management techniques to estimate their likely effectiveness. Some of these options for consideration in a lake nutrient management plan are discussed in the next step.

#### ***5. Management Practices for Nutrient Control***

Once the major sources of concern are identified and agreed on by the management planners, remedial measures appropriate to these sources must be identified. Management practices are well defined and documented for a variety of land uses in EPA guidance documents, USDA manuals, U.S. Forest Service manuals, and urban land use planning guides. The resource manager should study these references for likely approaches to consider and then consult regional experts in each of the subject land uses for qualification and other suggested management practice recommendations. Bringing these specialists together as a small workgroup is an effective, although sometimes contentious, way to develop the most technically sound approaches to these chosen problems.

Fitting the various components together in a comprehensive management plan is challenging. It calls for both imagination and a sense of cooperation. Usually no one approach stands out as the obvious best choice. Instead, two or three permutations of several generally agreed on BMPs will evolve from the planning sessions.

Selection of the optimal approach—or more likely, the best candidates—should first involve a careful assessment by the planning workgroup and then consultation with all elements of the watershed community, both organized interest groups and private landowners. The first phase of this selection process should include review by a threefold framework of evaluation. This approach was developed by the Department of Resource Development at Michigan State University (Figure 8.2) The premise behind this approach is essentially that the most effective and achievable management plan should be able to address three elements of practicality:

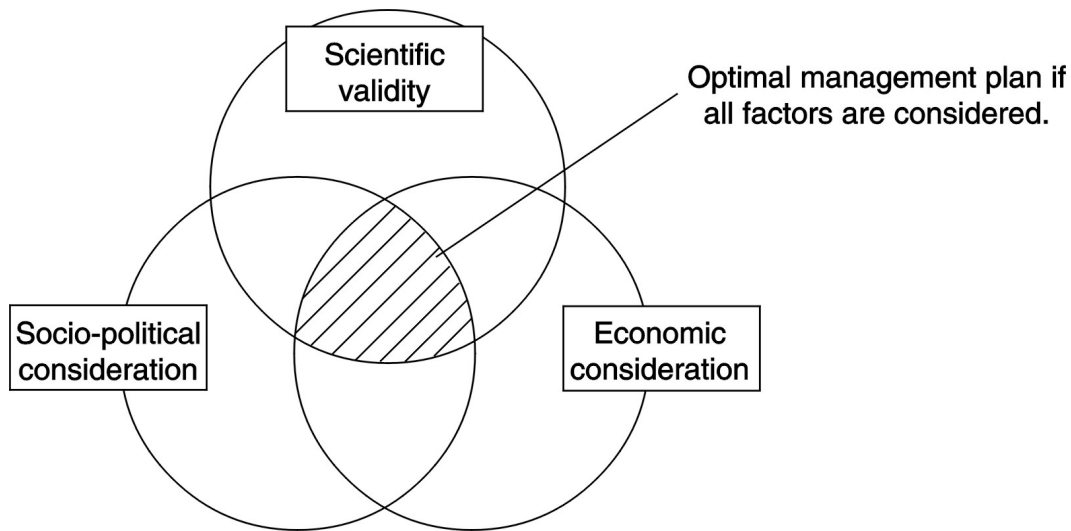

**Figure 8.2. “Threefold framework” of evaluation.**

- No resource or environmental management plan should even be considered unless it is scientifically valid. The technology proposed should be based in sound science and tested and validated. No attempt to manipulate the environment and peoples’ land use prerogatives should be made unless it can be demonstrated in advance that the technique is reliable or at least that the risks are quantifiable and understandable.
- The approach proposed should be cost-effective and affordable by the community. EPA has a series of economic tests that can be applied to standards development that can be adapted to management planning for a similar result. Among technically sound plans to achieve desired goals, the most cost-effective plans (typically those with elements that have the greatest benefit-cost ratios) are most likely the easiest to implement and the most likely to satisfy the public interest.
- The management plan should have an adequate degree of social and political acceptability. That which is eminently rational and cost-effective may conflict with the collective values of most of the local public. This is particularly important if taxing or regulatory actions are part of the management plan. Any form of regulation or permit action taken in addition to existing requirements should always be carefully researched through the responsible local, State, and

Federal agencies as to the justification, efficacy, lead time required, and likely effects on various segments of the community.

The resource manager most likely to achieve success will consider and responsibly address each of these three elements. All candidate alternatives should be evaluated in this manner and revised as necessary. This not only generates the optimal plan (or plans where competing but different strengths are evident), but it documents the rationale for that decision essential to public review before the final selection is made.

Involving the public in the process throughout is highly beneficial, and meetings or advisories to all potentially interested parties should be regularly provided, if not from the outset of the availability of definitive data, then certainly before the time when plan selection and approval are needed. A balance in public information must be struck between making announcements too early, which may needlessly arouse people before sufficient information has been generated, and making announcements too late, which may lead to suspicions of keeping the public in the dark.

## ***6. Detailed Management Plan***

A detailed management plan should include all 10 steps of the process described here. The first five steps are necessary to get to the design of the plan, but they should also be included so that anyone reading it will understand what has gone into the effort.

Natural resource management efforts can include these three elements: education, financing, and regulation. Any resource management tool will fall into one of these broad categories, and it is good to try to initiate the various techniques in the same order as they are presented here. First, you should start with relatively low-cost information and education efforts to acquaint people with the problem and how you propose to address it—and not coincidentally, to get their suggestions and perceptions of the issue and approach. A good educational effort should be the incentive for volunteer agreements and cooperative action. A grant-in-aid or other assistance is often the key element necessary to further encourage individuals to adopt appropriate local lake protection practices. Regulatory actions are necessary and appropriate when mandated by law, where cooperation and compliance are unlikely to occur otherwise, and when voluntary efforts have clearly not been successful.

## ***7. Implementation and Communication***

In addition to the discussion about communication above, the progress review periods during the management project are opportunities to provide reports to administrators, other involved agencies, politicians interested in the project, the general public and landowners, and other interest groups. Such reports should be brief and candid. They will be part of the public record so all parties are properly informed, help avoid the postproject cry of not being adequately advised of what was going on, and document the techniques and methods used for future consideration.

Regional public meetings and hearings are an excellent way to accomplish this communication. The more controversial an issue, the more this is necessary and the more important it is to listen carefully to the responses and to objectively weigh appropriate adjustments to the plan. To charge ahead in the face of significant opposition without evaluating the consequences is folly. This is especially true if a change to a stepwise approach in the management plan with additional public consultation would still achieve the same objective.

## ***8. Evaluation Monitoring and Periodic Review***

The management plan should always include “before,” “during,” and “after” water resource quality monitoring to demonstrate the relative response of the system to management efforts. This is why the initial survey stations should generally be maintained and expanded. Such monitoring data are important as a benchmark for evaluating progress and are an important component in the requisite progress reports described above. The change or lack thereof of the lake or reservoir is the ultimate determination of management success.

These built-in monitoring schedules should include seasonality and periodic data assessment intervals for management review to permit responses to changing circumstances, modifications of methods, schedules, and changes of emphasis as needed.

## ***9. Completion and Evaluation***

Management projects are frequently planned, initiated, and concluded, with new initiatives undertaken to meet pressing schedules, without sufficiently evaluating what was initially accomplished.

Review of the progress reports, of the original objectives, and of the monitoring data will reveal whether the lake or reservoir trophic state was successfully protected or improved. Just as important, this evaluation provides the documentation necessary to determine if methods and techniques attempted in this instance can be applied elsewhere, perhaps with modification. Alternatively, it will also reveal if mistakes were made that should be noted and avoided in future projects and perhaps that a sequel project is required to fully accomplish the original objectives.

## ***10. Continued Monitoring of the System***

The database initiated and expanded in the course of the project can now be reduced to the periodic measuring of key variables at critical times and locations. The purpose now is to keep sufficiently informed of the status of the lake or reservoir to ensure that the protection or remediation achieved is maintained. If periodic evaluation monitoring indicates a return of trophic decline, intervention should be possible at an early point so that costs of preserving that which was achieved are reduced. The evaluation and periodic monitoring steps of this process essentially close the loop. If new issues arise, the manager returns to step one with a new problem statement. General guidelines associated with evaluation monitoring are provided below.

### **■ Parameters To Sample**

Each of the water quality parameters discussed in the Indicators chapter (i.e., TP, TN, chlorophyll, Secchi depth, and dissolved oxygen) should be sampled during maintenance monitoring. Because the purpose of maintenance monitoring is to determine if conditions change or if criteria are exceeded, other physical or chemical variables need not be measured.

### **■ Sampling Frequency**

Sampling efforts for maintenance monitoring can be adaptive and sequential, so that a certain minimum of information is collected at regular intervals, and if data indicate change or uncertainty, the sampling effort (in both time and space) can be increased to attempt to reduce the uncertainty. For example, a lake in an undisturbed area could be sampled once every 5 years, from a single visit during an

index period (say, spring turnover). If results suggest a change in lake conditions beyond what is normally expected for a lake of its class, then additional sampling of the lake can be continued to determine if the departure from “normal” conditions is real and if it is ecologically significant. If TP, TN, chlorophyll *a*, and Secchi depth relationships have been established, it may be cost-effective to use Secchi depth as a preliminary indicator; if a trigger value is detected, more parameters would be measured.

This also suggests different levels of maintenance monitoring, depending on existing knowledge of a lake and expectations. Maintenance monitoring may be done for several purposes:

- Routine monitoring of a lake of known quality (i.e., has been sampled before) that is not expected to change greatly
- Initial sampling of a lake of unknown quality
- Monitoring of a lake of known quality that is expected to change, as with watershed development or following restoration efforts

Routine monitoring of lakes of known quality is the least intensive and would typically require sampling once every several years, as in the example above. Initial sampling of a lake of unknown quality requires the same sampling effort, and parameters, as the classification survey. Monitoring a known lake that is expected to change or suspected to have changed requires more intensive effort, typically an increase in sampling frequency to several times during the growing season to obtain seasonal averages of indicator values.

The actual frequency of sampling should be determined by the number of samples required to detect an ecologically relevant change in the indicators of a single lake, resources available for the monitoring program, and amount of time for a change to be detected. These considerations require power analysis using existing or preliminary data (see Chapter 9), and tradeoffs of desired significance level, desired power, desired effect size that is detectable, ecological significance, and most important, resources (labor and money) available for the monitoring program.

### ■ Sampling Location

For routine monitoring, it is recommended that the sampling locations be the same as for the classification survey, whether a single midlake site, a spatially composite sample, or separate sampling sites within a lake.

### E. Resources

Listed below are selected publications concerning lake and watershed management and protection.

- *Cooke, GD; Welch, EB; Peterson, SA; Newroth, PR. 1993. Restoration and management of lakes and reservoirs, 2nd ed. Boca Raton: Lewis Publishers.*  
This book is a current description of effective in-lake management techniques and approaches. It is an extensive account of the state of the art and science of in-basin lake management techniques.



- *Sharpley, AN (ed). 2000. Agriculture and phosphorus management: the Chesapeake Bay. Boca Raton: Lewis Publishers*

This text is a compilation of conference proceedings describing nutrient dynamics in the watershed of Chesapeake Bay with emphasis on agricultural loadings and practices. Although directed at an estuarine environment, much of the agriculturally based nutrient information has broad application.
- *U.S. Environmental Protection Agency. 1993. Guidance Specifying Management Measures for Sources of Nonpoint Pollution in Coastal Waters. (EPA-840-B-92-002)*

The EPA Office of Water produced the 1993 guidance document to support the Coastal Zone Act Reauthorization Amendments of 1990. This document describes several management measures to control nonpoint sources of pollution, including nutrients.
- *U.S. Environmental Protection Agency. 1990. Monitoring lake and reservoir restoration: technical supplement to lake and reservoir restoration guidance manual. (EPA-440/4-90-007)*

This document focuses on effective water quality monitoring techniques to assess status and trends of inland lakes and reservoirs. It was prepared by a panel of highly experienced State lake management specialists and emphasizes practical and cost effective measurement techniques.
- *U.S. Environmental Protection Agency. 1995. Watershed Protection: A Project Focus (EPA 841-R-95-003)*

This document focuses on developing watershed-specific programs or projects. It provides a blueprint for designing and implementing watershed projects, including references and case studies for specific elements of the process. The document illustrates how the broader principles of watershed management—including all relevant Federal, State, Tribal, local, and private activities—can be brought to bear on water quality and ecological concerns.
- *U.S. Environmental Protection Agency. 1995. Watershed Protection: A Statewide Approach (EPA 841-R-95-004)*

This document is primarily designed for State water quality managers. A common framework for a statewide watershed approach focuses on organizing and managing a State's major watersheds (called basins in this document). In this statewide approach, activities such as water quality monitoring, planning, and permitting are coordinated for multiple agencies on a set schedule within large watersheds or basins.
- *U.S. Environmental Protection Agency. 1997. Monitoring Consortiums: A Cost-Effective Means to Enhancing Watershed Data Collection and Analysis (EPA 841-R-97-006)*

This document addresses coordination in watershed monitoring. As demonstrated in the document's four case studies, consortiums can stretch the monitoring dollar, improve cooperation among partners, and increase sharing of expertise as well as expenses of data collection and management.
- *U.S. Environmental Protection Agency. 1997. Land Cover Digital Data Directory for the United States (EPA 841-B-97-005)*

Land cover, which is the pattern of ecological resources and human activities dominating different areas of the earth's surface, is one of the most important data sources used in watershed analysis and the management of water resources throughout the country. The 75 land cover data summaries in this directory include contact information to assist readers who may want to acquire copies of the digital data for their own use.

- *U.S. Environmental Protection Agency. 1997. Designing an Information Management System for Watersheds* (EPA 841-R-97-005)

This document is an introduction to the information management responsibilities and challenges facing any watershed group. The document reviews the fundamentals of identifying information management needs, integrating different databases, evaluating hardware and software options, and developing implementation plans.
- *U.S. Environmental Protection Agency. 1997. Information Management for the Watershed Approach in the Pacific Northwest* (EPA 841-R-97-004)

This document centers on a series of interviews with leaders and key participants in the statewide watershed approach activities in the State of Washington. The document reviews Washington's statewide watershed activities in case study fashion.
- *U.S. Environmental Protection Agency. 1998. Inventory of Watershed Training Courses* (EPA 841-D-98-001)

This inventory provides one-page summaries of 180 watershed-related training courses offered by Federal and State agencies; it also lists resource professionals in the private sector.
- *U.S. Environmental Protection Agency. 1997. Statewide Watershed Management Facilitation* (EPA 841-R-97-011)

This document addresses statewide watershed management and the process of facilitating the development or reorientation of statewide watershed programs. It includes state case histories.
- *U.S. Environmental Protection Agency. 1996. Watershed Approach Framework* (EPA 840-S-96-001)

This publication revisits and updates EPA's vision for a watershed approach, first explained in a 1991 document entitled "Watershed Protection Approach Framework." It describes watershed approaches as coordinating frameworks for environmental management that focus public and private efforts to address the highest priority problems defined geographic areas, involving both ground and surface water flow.
- *U.S. Environmental Protection Agency. 1997. Top 10 Watershed Lessons Learned* (EPA 840-F-97-001)

Watershed work has been going on for many years now, and this 60-page document summarizes the top lessons that have been learned by watershed practitioners across the United States regarding what works and what does not.
- *U.S. Environmental Protection Agency. 1999. Catalog of Federal Funding Sources for Watershed Protection (second ed.)* (EPA 841-B-99-003)

Many sources of Federal funding are available to support different aspects of watershed protection and specific types of local-level watershed projects. This document presents information on 52 Federal funding sources (grants and loans) that may be used to fund a variety of watershed projects.
- *U.S. Environmental Protection Agency. 1997. Watershed Training Opportunities* (EPA 841-B-97-008)

This is a 22-page booklet developed to highlight watershed training opportunities offered by EPA's Office of Water and the Watershed Academy. It covers training courses and educational materials on watersheds produced throughout the EPA Office of Water.

- *U.S. Environmental Protection Agency. 1997. Stream Corridor Restoration: Principles, Processes and Practices* (EPA 841-R-97-011)  
This document is a practical reference manual and logical framework to help environmental managers recognize stream restoration needs and design and implement restoration projects.
- *U.S. Environmental Protection Agency. 1997. Protocol for Developing Nutrient TMDLs* (EPA 841-B-99-007)  
This protocol is an organizational framework for the TMDL development process for nutrients. It leads to an understandable and justifiable TMDL.

# CHAPTER 9

## Modeling Tools

- A. Introduction
- B. Review of Lake/Reservoir Eutrophication Modeling Framework
- C. Model Use for Aiding in the Establishment of Reference Conditions
- D. Watershed Management Models

### A. Introduction

A variety of models are available that are related to assessment of nutrients in lakes and reservoirs. The use of models can include a wide range of applications, from evaluating in-lake trophic conditions to estimating loading from an entire watershed. After providing a brief review of lake and reservoir modeling frameworks, this chapter focuses on two areas where modeling can be applied with regard to the development and management of nutrient criteria. The first area is prediction or extrapolation of reference conditions, which are used as a basis for setting nutrient criteria (see Chapter 6). The second area deals with the use of models as tools for management in the watershed once nutrient criteria have been established and implemented (see Chapter 8). Readers are encouraged to consult the following references for more in-depth information on lake and reservoir modeling:

- Chapra, S. 1997. *Surface Water-Quality Modeling*. McGraw-Hill Publishers, Inc.
- Thomann, R.V., and J.A. Mueller. 1987. *Principles of Surface Water Quality Modeling and Control*. Harper & Row, New York.
- U.S. Environmental Protection Agency. 1990. *The Lake and Reservoir Restoration and Guidance Manual*. EPA/440/4-90/006. Office of Water, Washington, DC.
- U.S. Environmental Protection Agency. 1997. *Compendium of Tools for Watershed Assessment and TMDL Development*. EPA /841/b-97/006. Office of Water, Washington, DC.

### B. Review of Lake/Reservoir Eutrophication Modeling Frameworks

Modeling frameworks to simulate the impact of nutrients on the quality of standing waters can be divided into three general categories:

- Empirical models
- Nutrient budget/mass balance models
- Nutrient food chain models

These models are listed in order of increasing complexity and higher mechanistic definition. It should be stressed that higher complexity does not necessarily connote inherent superiority.

#### 1. Empirical Models

Empirical models are graphical approaches based on measurements from many lakes and reservoirs. The pioneering work in this area was performed by Vollenweider (1968, 1976) and Dillon and Rigler

(1974). Other investigators, notably Rast and Lee (1987) and Reckhow (1977), extended and broadened the approach.

Empirical models can be loosely divided into two categories: (1) phosphorus loading plots and (2) trophic parameter correlations. As depicted in Figure 9.1, phosphorus loading plots typically graph lakes on a two-dimensional space with the log of the areal phosphorus loading on the ordinate and the log of hydrogeometric parameters on the abscissa. For example, Figure 9.1 has the log of ratio of the lake's mean depth to its residence time as the abscissa. Lines are then superimposed to demarcate different trophic states. The plots then can be used to predict the trophic state of a lake based on its loading and hydrogeometry.

It should be noted that a number of investigators (e.g., Thomann, 1977; Chapra and Tarapchak, 1976; Vollenweider, 1976) have illustrated how such plots can be related to and derived from the simple phosphorus budget models to be described in the next section. Thus, aside from predicting trophic state, the plots can be structured to predict in-lake TP concentration as a function of loads.

Trophic parameter correlations are usually log-log plots relating two trophic parameters. For example, Figure 9.2 shows a correlation between chlorophyll *a* and TP concentration.

Empirical models have several strengths and weaknesses. Their strengths are:

- They are extremely easy to use.
- They provide a quick means to identify “outlier” lakes.
- If they are based on regional or local databases of relatively homogeneous populations of lakes (e.g., lime lakes in northern Michigan), they are capable of producing adequate predictions.

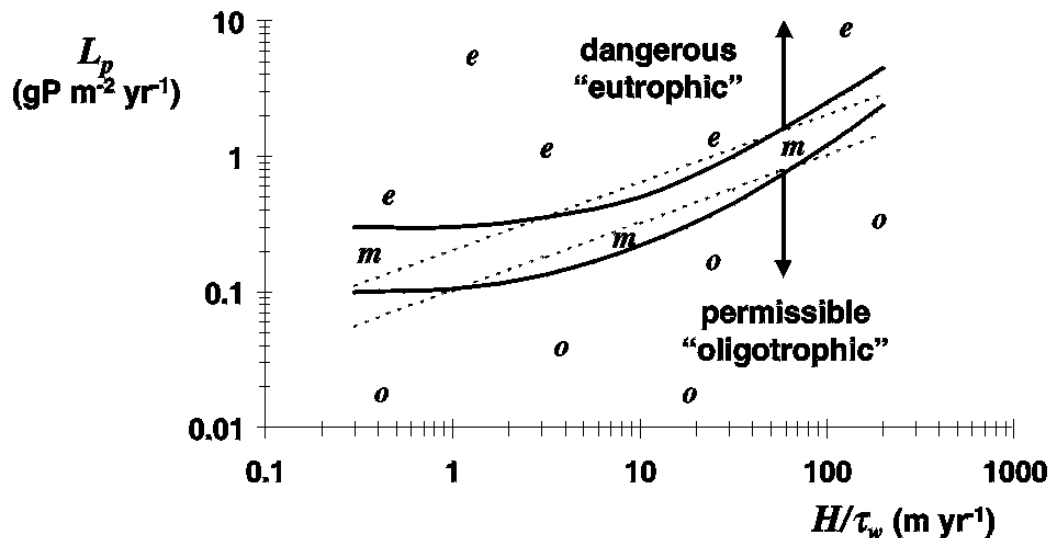
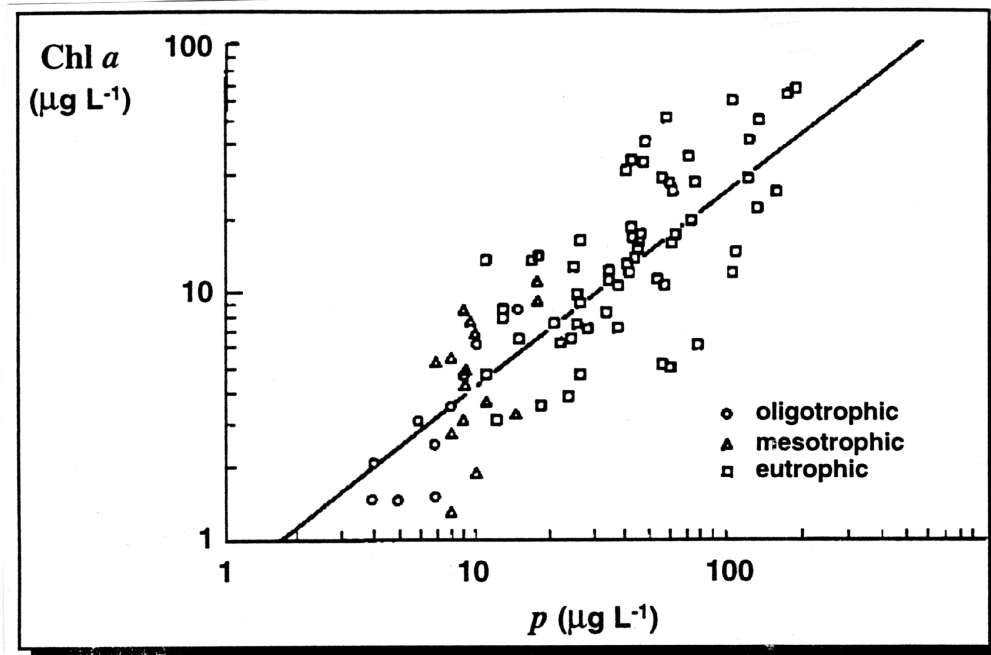

Figure 9.1. Vollenweider's loading plot (1975).



**Figure 9.2. Relationship between chlorophyll and phosphorus.** Trophic parameter correlations are usually log-log plots relating two trophic parameters. For example, Figure 9.2 shows a correlation between chlorophyll *a* and TP concentration.

Their primary weakness relates to the fact that, if based on global data (e.g., north temperate lakes), they tend to have very large standard errors of prediction. Unfortunately, the plots often are presented in a manner that does not make this uncertainty explicit. Hence, naive users can develop predictions and are unaware that their results may have substantial errors. A number of investigators, notably Reckhow and Walker, have worked to include uncertainty estimates with empirical model predictions.

In summary, although they have some utility, empirical models (and particularly those based on global data) do not usually have the required precision upon which high-cost decisions can be made. As such, empirical models should be relegated to broad screening applications and for identifying atypical lakes. However, they may have sufficient precision if developed and applied for regional populations of lakes and reservoirs.

## 2. *Nutrient Budget/Mass Balance Models*

Early on (e.g., Vollenweider, 1969), it was recognized that simple mass balance models could provide similar predictions to phosphorus loading plots. These models do not attempt a detailed characterization of the division of phosphorus within the water column. Rather, they focus of characterizing major inputs and outputs to predict the long-term trends of a lake's response to loading changes.

The simplest example of a TP budget model was developed by Vollenweider (1969) and modified by Chapra (1975):

$$V \frac{dp}{dt} = W - Qp - vAp$$

where  $V$  = volume,  $p$  = TP concentration,  $t$  = time,  $W$  = loading,  $Q$  = outflow,  $v$  = an apparent settling velocity, and  $A$  = surface area. As depicted in Figure 9.3a, the key feature of this model is the simple way in which it characterizes the input-output terms for TP. In particular, it attempts to characterize sedimentation losses as a simple one-way settling of TP.

As with loading plots, steady-state solutions can be developed by setting the derivative to 0 and solving for  $p = W/(Q + vA)$ . If levels of TP can be associated with trophic state, the model can be used to determine the loading required to maintain a particular lake at a desired quality in a fashion similar to the loading plots. The model also provides a framework to determine the temporal response of a lake to loading changes. Thus, it has the advantage over loading plots in that system dynamics can be characterized.

Phosphorus budget models have been improved in several ways:

- For incompletely mixed systems, the lake can be divided into a system of interconnected well-mixed systems. This can be done horizontally or vertically. For example, Chapra (1979) used two mass balances to characterize a lake with a major embayment. In a similar manner, O'Melia (1972) and others have vertically divided the water column of thermally stratified lakes into surface and bottom layers

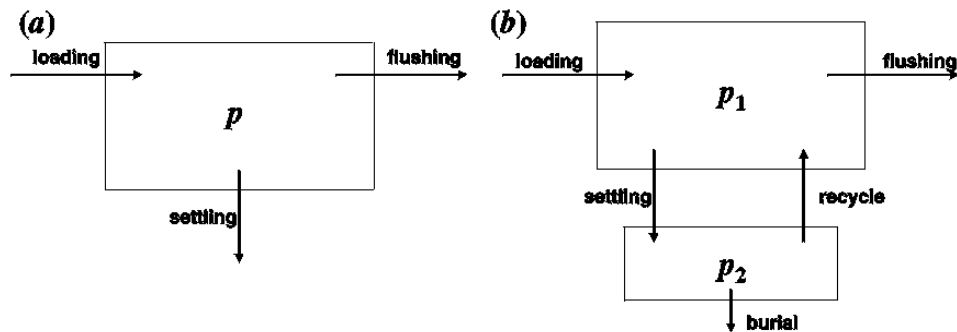

**Figure 9.3. Two phosphorus budget models: (a) characterizes sedimentation as a simple one-way loss to the sediments and (b) includes sediment feedback**

- Efforts have been made to better characterize sediment–water interactions. Chapra and Canale represented a lake and its underlying sediments as a two-layer system (Figure 9-3b). Along with phosphorus settling, this model also allows sediment feedback. A simple oxygen model is used to simulate hypolimnetic anoxia, which triggers sediment release of TP into the overlying waters. This mechanism is significant, because sediment feedback can retard the recovery of lakes after TP load reductions.
- Hybrid models have been developed that use mass balance and multiple segments to characterize transport, but to quantify kinetics, they use empirically derived relationships. Walker’s BATHTUB model for reservoirs is a good representative of this type.

In summary, the phosphorus budget models use simple mass balance to characterize how phosphorus levels change in lakes in response to load modifications. Thus, the assumption is made that “as goes phosphorus, so goes eutrophication.” Such models can be useful for simulating the long-term trends in the quality of phosphorus-limited lakes and reservoirs.

### **3. Nutrient/Food Chain Models**

In contrast to the budget models described above, nutrient/food chain models attempt to mechanistically characterize the partitioning of matter within the lake on a seasonal timeframe. These models were first developed in the 1970’s to expressly address the impact of nutrients on natural waters (e.g., Chen, 1970; Chen and Orlob, 1975; Di Toro et al., 1971; Canale et al., 1974). They typically have a number of common characteristics, including transport characterization and kinetic characterization.

#### **■ Transport Characterization**

An effort is made to characterize the internal physics of a lake or reservoir. Thus, rather than representing the lake as a single well-mixed entity, multiple segments typically are used to model the internal physics. The most common approach is to use two vertical layers to characterize thermal stratification. More refined vertical segmentation is sometimes used to resolve hypolimnetic gradients, particularly near the sediment–water interface. In addition, multiple horizontal segments are employed for incompletely mixed systems such as elongated reservoirs. There are two ways in which the magnitude of mixing and interflow between segments is modeled:

- First, it can be treated as a model input. This is done by specifying turbulent diffusion coefficients and intersegment flows. In many such applications, the temperature distribution is also treated as a model input.
- Second, water motion can be calculated internally using energy and momentum balances. Thus, a separate hydrodynamic model is used to supply the physics. In some cases, temperature is calculated as a part of the hydrodynamic simulation.

#### **■ Kinetic Characterization**

Matter in the lake is divided into several forms of nutrients and a food chain. A typical example of how this is done is shown in Figure 9.4. Several nutrients are typically included. Hence, the model is capable of simulating multiple nutrient limitation. As shown in the figure, phosphorus and nitrogen are the common choices. These usually are divided into available and unavailable components. The latter can be broken down further, for example, into dissolved and particulate fractions.



The food chain shown in the figure consists of a single algal compartment, along with two zooplankton compartments. Algae growth is calculated as a function of temperature, light, and available nutrient concentrations. All other rates are temperature dependent. All three organisms experience respiration/excretion losses. As shown in the figure, these can be released to either the available or unavailable nutrient pools. Grazing is inefficient, with a fraction of the grazing egested to the unavailable pools.

This framework can be simplified by dropping a nutrient (usually nitrogen). It is more likely to be made more complicated by adding nutrients (e.g., silicon) or making them more refined (e.g., breaking the unavailable components into dissolved and particulate fractions). The food chain can be made more complex by breaking the single algal compartments into components (e.g., diatoms, greens and blue-greens). Similar refinements can be made to the zooplankton. When this is done, feeding preferences usually must be specified. It should be noted that other variables such as oxygen and pH can be integrated into these frameworks. In these cases, it is usually necessary to simulate organic carbon.

This framework can be simplified by dropping a nutrient (usually nitrogen). It is more likely to be made more complicated by adding nutrients (e.g., silicon) or making them more refined (e.g., breaking the unavailable components into dissolved and particulate fractions). The food chain can be made more complex by breaking the single algal compartments into components (e.g., diatoms, greens and blue-greens). Similar refinements can be made to the zooplankton. When this is done, feeding preferences usually must be specified. It should be noted that other variables such as oxygen and pH can be integrated into these frameworks. In these cases, it is usually necessary to simulate organic carbon.

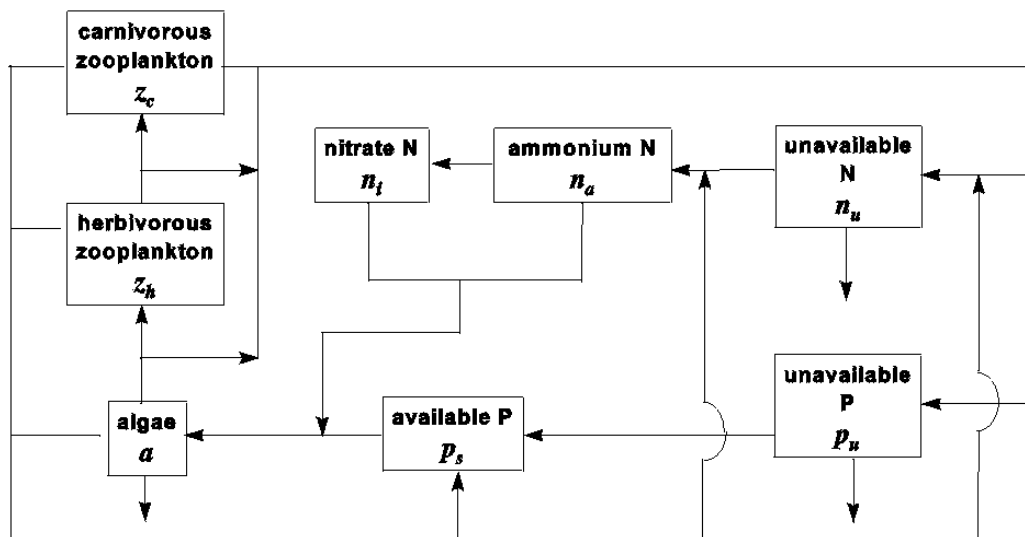

Figure 9.4. Kinetic segmentation.

## C. Model Use for Aiding in the Establishment of Reference Conditions

### 1. Morphoedaphic Index

The morphoedaphic index (MEI) is the ratio of total dissolved solids in lake water to the mean depth of the lake. Early studies suggested that the MEI was correlated with fish and phytoplankton production of lakes (e.g., Rawson, 1952; Ryder, 1965; Oglesby, 1977). The MEI approach was extended by Vighi and Chiaudani (1985) to predict phosphorus concentrations resulting from natural background loading in undisturbed watersheds. This prediction can, therefore, be used to predict reference phosphorus concentrations.

Using data from 53 cool-temperate lakes of North America and Europe, with negligible anthropogenic phosphorus input, Vighi and Chiaudani (1985) developed a regression equation predicting mean phosphorus concentration from the MEI, where MEI was calculated using either alkalinity or conductivity as a surrogate for total dissolved solids:

$$\begin{aligned}\text{Log [P]} &= 1.48 + 0.33 \text{ Log MEI}_{\text{alk}}; r = 0.83 \\ \text{Log [P]} &= 0.75 + 0.27 \text{ Log MEI}_{\text{cond}}; r = 0.71.\end{aligned}$$

Analysis of covariance showed no significant differences between the European and North American lakes, and lakes with known anthropogenic phosphorus inputs all fell above the estimated regression line for undisturbed lakes (Vighi and Chiaudani 1985). This MEI model is used by the Minnesota Pollution Control Agency (MPCA) to estimate background phosphorus concentrations and develop reference conditions for oligotrophic and mesotrophic lakes (see text box at end of this chapter). Many Minnesota lakes are similar to the lakes for which the model was developed: relatively deep cool-temperate lakes of glacial origin, which are oligotrophic to mesotrophic. The approach has not been calibrated or confirmed for shallow lakes, naturally eutrophic lakes, warm-temperate lakes, or impoundments. The MEI approach is simple and appears to be highly successful for a limited set of cool-temperate lakes. However, because its use has not been widespread (possibly because of its simplicity), it has not been calibrated and tested for a wider variety of lakes. Because this approach has potential, it needs to be recalibrated and tested with regional reference lake data sets.

### 2. Mass Balance Models with Loading Estimation

#### ■ Mass Balance Models

Mass balance models are a means of estimating concentrations of nutrients using knowledge of loading into a lake and hydrology of a lake. A mass balance model by itself will not establish reference conditions—it will predict nutrient concentrations given certain loading values. Therefore, to use a mass balance model to derive reference conditions for a lake, an estimate of the natural background nutrient loading to the lake is required. In the most basic steady-state mass balance phosphorus model, the equation for prediction of the concentration of phosphorus in a reservoir is produced by rearranging the mass balance equation (see Chapter 2) and solving for the concentration in the lake:

$$\begin{aligned}\text{Concentration (lake)} &= \text{Concentration (incoming water)} \times \text{Fraction NOT Sedimented} \\ \text{or} \\ C_L &= C_i \times (1 - R)\end{aligned}$$

$C_L$  and  $C_i$  are concentrations of the material in the lake (L) and in the incoming water (i), and R is the amount retained in the water column.  $C_i$  is usually calculated as the nutrient loading, J (mg/year), divided by the amount of water flowing out of the reservoir ( $m^3$ /year) to compensate for evaporation from the reservoir surface. The letter R represents the fraction of the material retained in the lake (i.e., sedimented). By subtracting the fraction sedimented from 1, the term “(1-R)” represents the fraction of the incoming concentration that can be found in the reservoir water (Dillon and Rigler, 1974). There are a number of methods for estimating (1-R), but one of the simplest, and yet one of the most consistently accurate, has been found to be:

$$1 - R = \frac{1}{1 + sT}$$

where T is the water residence time (Vollenweider, 1976; Larsen and Mercier, 1976). This equation implies that the retention of materials in the reservoir increases the longer the water remains in the reservoir (as the water residence time increases). This makes intuitive sense because it means there is more time for the phosphorus to sediment out of the water column. The effect is that the longer the water residence time, the lower the expected phosphorus concentrations in the reservoir. This becomes especially significant because watershed development not only affects nutrient loading through increases in nutrient concentration but also increases water flow into the reservoir, thus decreasing the water residence time and further increasing the in-reservoir phosphorus concentration.

The final predictive equation becomes:

$$C_L = C_i \frac{1}{1 + s\sqrt{T}}$$

In the context of estimating reference conditions, models of this type can be used to estimate the potential predisturbance condition of the water body. The incoming concentration ( $C_i$ ) does not necessarily have to represent the present or future concentration in the incoming stream. If there are undisturbed streams in the region, then the concentrations in those streams can be used instead to estimate the theoretical undisturbed condition. Some error would be introduced because water flow, and therefore the water residence time (T), also may be affected by disturbance; the estimated value would then underestimate the reference phosphorus condition.

## ■ Receiving Water Models

Receiving water models are used to examine the interactions between loadings and response, evaluate loading capacities, and test various loading scenarios. As with watershed loading models, receiving water models vary widely in complexity. For traditional point source abatement, where biodegradable pollutant discharges are the major concern, simple steady-state models of the dissolved oxygen balance are commonly used by planners and pollution control authorities. For assessment of eutrophication and toxics, more comprehensive models have evolved to incorporate a wider range of processes. Other recent reviews of receiving water models include Ambrose et al. (1995).

A fundamental concept for the analysis of receiving water body response to point and nonpoint source inputs is the principle of mass balance (or continuity). Receiving water models typically develop a mass balance for one or more interacting constituents, taking into account three factors: transport through the system, reactions within the system, and inputs into the system. The first factor describes the

hydrologic and hydrodynamic regime of the water system; the second, the biological, chemical, and physical reactions that affect constituents; and the third, the inputs to or withdrawals from the system because of anthropogenic activities and natural phenomena (O’Conner et al., 1975). The complexity of a receiving water model depends on the way in which these three factors are incorporated. The simplest models use a steady-state one-dimensional framework with steady inputs. The more complex models typically use hydrodynamic relationships, consider interactions between constituents, allow distributed nonpoint inputs, and are capable of providing dynamic, multidimensional simulations.

The various physical, chemical, and biological processes considered by a receiving water model are represented mathematically by mechanistic and/or empirical relationships between forcing functions and state variables (Jorgensen, 1995). Forcing functions are variables or functions of an external nature that are regarded in the model formulation as directly influencing the state of the receiving water body. Point and nonpoint source loadings to the water body are examples of forcing functions; other examples are temperature and solar radiation. State variables, such as dissolved oxygen and chlorophyll *a* concentrations, define the state of the receiving water body. When the predicted values of state variables change because of changes to forcing functions, the state variables are regarded as model outputs. In the context of TMDL development, the typical situation would involve manipulating forcing functions that are controllable (e.g., point source loadings and, to an extent, nonpoint source loadings) and observing the effect on state variables of interest.

Receiving water models are typically described in terms of their representation of space (spatial domain), time (temporal domain), flow simulation (hydrodynamics), transport processes, inputs (forcing functions), and state variables. Other factors considered in the review of receiving water models include user interface and inherent application complexity. Receiving water models can be grouped generally into three classes—hydrodynamic models, steady-state water quality models, and dynamic water quality models. Water quality models can simulate the chemical and biological processes that occur within a water body system based on external and internal inputs and reactions. Because steady-state water quality models are the most commonly used and the easiest to implement, a select few are described below. For more information on hydrodynamic models and dynamic water quality models, the reader is referred to U.S. EPA, 1997.

#### *Watershed and Lake Modeling Software (EUTROMOD)*

EUTROMOD is a spreadsheet-based modeling procedure for eutrophication management developed at Duke University and distributed by the North American Lake Management Society (Reckhow, 1990). The steady-state modeling system allows for internal calculations of both nonpoint source loading and lake response. The system estimates nutrient loadings, various trophic state parameters, and trihalomethane concentrations in lake water. The computation algorithms used in EUTROMOD were developed based on statistical relationships and a continuously stirred tank reactor model. Model results include the most likely predicted phosphorus and nitrogen loading for the watershed and for each land use category. The model also determines the lake response to various pollution loading rates. The spreadsheet capabilities of the model allow graphical representations of the results and data export to other spreadsheet systems for statistical analyses. The model was used in conjunction with a Geographic Information System (GIS) for establishing TMDLs to Wister Lake, Oklahoma (Hession et al., 1995).

#### *Seasonal and Long-Term Trends of Total Phosphorus and Oxygen in Stratified Lakes (PHOSMOD)*

PHOSMOD is a budget model that can predict the long-term response of a lake to changes in phosphorus loading (Chapra and Canale, 1991). In the model, the lake is treated as two layers: a water

layer and a surface sediment layer. A TP budget for the water layer is developed with inputs from external loading and recycling from the sediments and considering losses due to flushing and settling. In the sediment layer budget, TP is gained by settling and lost by recycling and burial. The sediment-to-water recycling is dependent on the levels of sediment TP and hypolimnetic oxygen, with the concentration of the latter estimated with a semiempirical model. Chapra and Canale (1991) present an application of the model and an analysis to demonstrate how the model predictions replicate in-lake changes not possible with simpler phosphorus budget models.

### *BATHTUB*

FLUX, PROFILE, and BATHTUB (Walker, 1986) are a collection of programs designed to assist in the data reduction and model implementation phases of eutrophication studies in lakes and reservoirs. FLUX is a tool for data reduction and preprocessing of tributary nutrient loadings from grab sampling and flow records. The program can assist in error detection and sampling program design. PROFILE provides displays of lake water quality data and assists in analysis of sampling information. Data analysis procedures include hypolimnetic oxygen depletion rates, spatial and temporal variability, and statistical summaries. BATHTUB allows the user to segment the lake into a hydraulic network. Nutrient balance and eutrophication models can be applied to the network to assess advection, dispersion, and nutrient sedimentation. Empirical relationships that have been calibrated and tested for reservoir applications are used to predict eutrophication-related water quality conditions. The segmented structure of BATHTUB allows its application to single reservoirs, partial reservoirs, networks of reservoirs, or collections of reservoirs, permitting regional comparative assessments of reservoir conditions, controlling factors, and model performance. Inputs and outputs can be expressed in probabilistic terms to account for limitations in input data and intrinsic model errors. The programs and models have been applied to U.S. Army Corps of Engineer reservoirs (Kennedy, 1995), as well as a number of other lakes and reservoirs. BATHTUB has been cited as an effective tool for lake and reservoir water quality assessment and management, particularly where data are limited (Ernst et al., 1994).

### *AQUATOX*

A receiving water and food chain model will soon be released by the EPA Office of Science and Technology. AQUATOX is designed to simulate the biological, physical, and chemical processes within a water body in response to stressors. Parameters include phosphorus, nitrogen, chlorophyll *a*, Secchi depth, dissolved oxygen, macrophytes, and several trophic groups of invertebrates and fish. It is a time-variable model expected to predict seasonal changes, such as when different algal groups may bloom and lake ecosystem responses to changes in nutrient loading or other management measures.

AQUATOX is expected to provide the user with a great deal of data in the form of data libraries, which can be used “as is” or edited by the user to better characterize a water body. It has been validated for nutrients on a stratified eutrophic lake in New York and a reservoir in Iowa. It will be undergoing peer review in 2000.

### ■ **Simple Watershed-Scale Loading Models**

Watershed-scale loading models are good choices to use to estimate nutrient loads entering lakes and reservoirs. For discussion purposes, watershed-scale loading estimation methods can be divided into three general categories based on complexity, operation, time step, and simulation technique—simple methods, mid-range models, and detailed models (U.S. EPA, 1997). Simple methods are the most

suitable for aiding in the prediction of reference conditions. Mid-range and detailed watershed-scale loading models are more advantageous for watershed management applications, as detailed below.

Simple methods are generally empirical in nature. The major advantage of empirical methods is that they can provide a means of developing regional reference conditions with less effort and data requirements than more complex simulation models. These methods are compilations of expert judgment and empirical relationships between physiographical characteristics of the watershed and pollutant export, or they are estimates based on existing data. They are the most suitable models for developing regional reference conditions and making regional predictions, but they are the least suitable models for aiding watershed management and lake management decisions.

Typically, simple methods rely on large-scale aggregation and neglect important features of small patches of land. They rely on generalized sources of information and therefore have low to medium requirements for site-specific data. Default values provided for these methods are derived from empirical relationships that are evaluated based on regional or site-specific data. The estimations usually are expressed as mean annual values. Simple methods provide aggregated (e.g., annual average) estimates of sediment and pollutant loadings, but they have limited predictive capability for short-term loading or events. The empiricism contained in the models limits their transferability to other regions. Because they often neglect seasonal variability, simple methods might not be adequate to model short-term water quality problems for which specific loadings of shorter duration are important.

Pollutant loads are determined from export coefficients (e.g., the Watershed model) or as a function of the sediment yield (e.g., EPA screening procedures, SLOSS-PHOSPH). The Simple Method, the U.S. Geological Survey (USGS) regression method, and the Federal Highway Administration model are statistically based approaches developed from past monitoring information. In general, the application of empirical models is limited to the watershed types for which they were developed, with similar land uses or activities. Applications to new areas requires recalibration with relevant data.

Selected simple empirical watershed-scale loading models are described below (U.S. EPA, 1997).

#### *Reckhow-Simpson Model*

This approach (Reckhow and Simpson, 1980) uses a simple mass balance model with empirical predictions of phosphorus loading rates from different land uses to predict mean lake phosphorus concentration. The mass-balance equation uses phosphorus loading, water loading, and an empirically derived settling velocity for phosphorus to estimate phosphorous concentration. Users must derive high, median, and low estimates of phosphorus export coefficients from agricultural, forest, and urban land, as well as septic fields and precipitation. The high and low estimates are used to bracket uncertainty of the best estimate.

#### *EPA Screening Procedures*

The EPA screening procedures, developed by the EPA Environmental Research Laboratory in Athens, Georgia (McElroy et al., 1976; Mills, 1985), include methodologies to calculate pollutant loads from point and nonpoint sources, including atmospheric deposition, for preliminary assessment of water quality. The procedures consist of loading functions and simple empirical expressions relating nonpoint pollutant loads to other readily available parameters. Data required generally include information on land use/land cover, management practices, soils, and topography. Although these procedures are not coded into a computer program, several computer-based models have adapted the loading function

concept to predict pollutant loadings. An advantage of this approach is the possibility of using readily available data as default values when site-specific information is lacking. Application of these procedures requires minimum personnel training and practically no calibration. However, application to large, complex watersheds should be limited to planning activities. Many of the techniques included in the manual were incorporated into current models such as Generalized Watershed Loading Functions (GWLF).

#### *USGS SPARROW Regression Approach*

The SPARROW regression is very similar to the storm runoff model (described below), and is based on hydrologic unit-level discharge data from USGS gaging stations (Smith et al., 1997). The model was developed from nationwide data (414 stations for up to 15 years). The SPARROW approach considered four sources of total nitrogen and TP: point sources, fertilizer, livestock waste, and runoff from nonagricultural land. Atmospheric nitrogen deposition also was included in the nitrogen model (Smith et al., 1997). The model estimated land surface delivery (of nonpoint source runoff) and instream decay (denitrification or settlement) of the nutrients. A possible drawback of the approach for estimating reference conditions is that nonagricultural land uses were lumped as a single category (Smith et al., 1997). The model was developed from nationwide data; use of this method for extrapolation of regional reference conditions would require reestimation and calibration using relevant regional data. While time consuming and data intensive, regional recalibration should result in more precise estimates than the national model.

#### *Simple Method*

The Simple Method is an empirical approach developed for estimating pollutant export from urban development sites in the Washington, DC, area (Schueler, 1987). It is used at the site-planning level to predict pollutant loadings under a variety of development scenarios. Its application is limited to small drainage areas of less than a square mile. Pollutant concentrations of phosphorus, nitrogen, chemical oxygen demand, biochemical oxygen demand, and metals are calculated from flow-weighted concentration values for new suburban areas, older urban areas, central business districts, hardwood forests, and urban highways. The method relies on the National Urban Runoff Program (NURP) data for default values (U.S. EPA, 1983). A graphical relationship is used to determine the event mean sediment concentration based on readily available information. This method is not coded into a computer program but can be easily implemented with a hand-held calculator.

#### *USGS Regression Approach*

The regression approach developed by USGS researchers is based on a statistical description of historic records of storm runoff responses on a watershed level (Tasker and Driver, 1988). This method may be used for rough preliminary calculations of annual pollutant loads when data and time are limited. Simple regression equations were developed using available monitoring data for pollutant discharges at 76 gaging stations in 20 States. Separate equations are given for 10 pollutants, including dissolved and total nutrients, chemical oxygen demand, and metals. Input data include drainage area, percent imperviousness, mean annual rainfall, general land use pattern, and mean minimum monthly temperature. Application of this method provides storm-mean pollutant loads and corresponding confidence intervals. The use of this method as a planning tool at a regional or watershed level might require preliminary calibration and verification with additional, more recent monitoring data.

### *Simplified Pollutant Yield Approach (SLOSS-PHOSPH)*

This method uses two simplified loading algorithms to evaluate soil erosion, sedimentation, and phosphorus transport from distributed watershed areas. The SLOSS algorithm provides estimates of sediment yield, whereas the PHOSPH algorithm uses a loading function to evaluate the amount of sediment-bound phosphorus. Application to watershed and subwatershed levels was developed by Tim et al. (1991) based on an integrated approach coupling these algorithms with VirGIS (Virginia GIS). The approach was applied to the Nomini Creek watershed, Westmoreland County, Virginia, to target critical areas of nonpoint source pollution at the subwatershed level (U.S. EPA, 1992c). In this application, analysis was limited to phosphorus loading; however, other pollutants for which input data or default values are available can be modeled in a similar fashion. The approach requires full-scale GIS capability and trained personnel.

### *Watershed*

Watershed is a spreadsheet model developed at the University of Wisconsin to calculate phosphorus loading from point sources, combined sewer overflows, septic tanks, rural croplands, and other urban and rural sources. It can be used to evaluate the tradeoffs between control of point and nonpoint sources (Walker et al., 1989). It uses an annual time step to calculate total pollution loads and to evaluate the cost-effectiveness of pollution control practices in terms of cost per unit load reduction. The program uses a series of worksheets to summarize watershed characteristics and to estimate pollutant loadings for uncontrolled and controlled conditions. Because of the simple formulation describing the various pollutant loading processes, the model can be applied using available default values with minimum calibration effort. Watershed was applied to study the tradeoffs between controlling point and nonpoint sources in the Delavan Lake watershed in Wisconsin.

### *Federal Highway Administration Model*

FHWA's Office of Engineering and Highway Operations has developed a simple statistical spreadsheet procedure to estimate pollutant loading and impacts to streams and lakes that receive highway storm water runoff (FHWA, 1990). The procedure uses several worksheets to tabulate site characteristics and other input parameters, as well as to calculate runoff volumes, pollutant loads, and the magnitude and frequency of occurrence of instream pollutant concentrations. The FHWA model uses a set of default values for pollutant event-mean concentrations that depend on traffic volume and the rural or urban setting of the highway's pathway. FHWA uses this method to identify and quantify the constituents of highway runoff and their potential effects on receiving waters and to identify areas that might require controls.

### *Watershed Management Model*

The Watershed Management Model (WMM) was developed for the Florida Department of Environmental Regulation for watershed management planning and estimation of watershed pollutant loads (Camp et al., 1992). Pollutants simulated include nitrogen, phosphorus, lead, and zinc from point and nonpoint sources. The model is implemented in the Lotus 1-2-3 spreadsheet environment and will thus calculate standard statistics and produce plots and bar charts of results. Although it was developed to predict annual loadings, WMM can be adapted to predict seasonal loads provided that seasonal event mean concentration data are available. In the absence of site-specific information, the event concentrations derived from NURP surveys may be used as default values. The model includes computational components for stream and lake water quality analysis using simple transport and



transformation formulations based on travel time. WMM has been applied to several watersheds, including the development of a master plan for Jacksonville, Florida, and the Part II estimation of watershed loadings for the National Pollutant Discharge Elimination System permitting process. It also has been applied in Norfolk County, Virginia; to a watershed management plan for North Carolina; to a wasteload allocation study for Lake Tohopekaliga, near Orlando, Florida; and for water quality planning in Austin, Texas (Pantalion et al., 1995).

#### **D. Watershed Management Models**

As watershed-based assessment and integrated analysis of point and nonpoint source pollution have become the focus of governmental water programs, modeling has been used to evaluate a wider range of pollutant generation, transport, control, and environmental response issues (U.S. EPA, 1997). Management goals such as pollutant source identification and prioritization, prediction and estimation of lake and reservoir response to watershed nutrient control practices, and long-term evaluation of a watershed system's response to management efforts can be addressed using modeling techniques. This section discusses the use of watershed loading models and receiving water models for management purposes.

##### ***1. Mid-Range Watershed-Scale Loading Models***

The advantage of mid-range watershed-scale loading models is that they evaluate pollution sources and impacts over broad geographic scales and therefore can assist in defining target areas for pollution mitigation programs on a watershed basis. Several mid-range models are designed to interface with GISs, which greatly facilitate parameter estimation. Greater reliance on site-specific data gives mid-range models a relatively broad range of regional applicability. However, the use of simplifying assumptions can limit the accuracy of their predictions to within about an order of magnitude (Dillaha, 1992) and can restrict their analysis to relative comparisons.

This class of model attempts a compromise between the empiricism of the simple methods and the complexity of detailed mechanistic models. Mid-range models use a management-level approach to assess pollutant sources and transport in watersheds by incorporating simplified relationships for the generation and transport of pollutants. Mid-range models, however, still retain responsiveness to management objectives and actions appropriate to watershed management planning (Clark et al., 1979). They are relatively simple and are intended to be used to identify problem areas within large drainage basins or to make preliminary, qualitative evaluations of best management practices (BMP) alternatives (Dillaha, 1992).

Unlike the simple methods, which are restricted to predictions of annual or storm loads, mid-range tools can be used to assess the seasonal or interannual variability of nonpoint source pollutant loadings and to assess long-term water quality trends. Also, they can be used to address land use patterns and landscape configurations in actual watersheds. They are based primarily on empirical relationships and default values. In addition, they typically require some site-specific data and calibration.

Mid-range models are designed to estimate the importance of pollutant contributions from multiple land uses and many individual source areas in a watershed. Thus, they can be used to target important areas of pollution generation and identify areas best suited for controls on a watershed basis. Moreover, the continuous simulation furnished by some of these models provides an analysis of the relative importance of sources for a range of storm events or conditions. In an effort to reduce complexity and data requirements, these models often are developed for specific applications. For instance, mid-range

models can be designed for application to agricultural, urban, or mixed watersheds. Some mid-range models simplify the description of transport processes while emphasizing possible reductions available with controls; others simplify the description of control options and emphasize changes in concentrations as pollutants move through the watershed.

Because mid-range models attempt to use smaller time steps to represent seasonal variability, they require additional meteorologic data (e.g., daily weather data for the GWLF, hourly rainfall for SITEMAP). They also attempt to relate pollutant loadings to hydrologic (e.g., runoff) and erosion (e.g., sediment yield) processes. These models usually include adequate input-output features (e.g., AGNPS, GWLF), making applications easier to process. Several of these models (SITEMAP, Auto-QI) were developed in existing computing environments (e.g., Lotus 1-2-3) to make use of their built-in graphical and statistical capabilities. Neither the simple nor the mid-range models consider degradation and transformation processes, and few incorporate adequate representation of pollutant transport within and from the watershed. Although their applications might be limited to relative comparisons, they can often provide water quality managers with useful information for watershed-level planning decisions.

Selected mid-range models are described below:

#### ■ **Stormwater Intercept and Treatment Evaluation Model for Analysis and Planning (SITEMAP)**

SITEMAP, previously distributed under the name NPSMAP, is a dynamic simulation program that computes, tabulates, and displays daily runoff, pollutant loadings, infiltration, soil moisture, irrigation water demand, evapotranspiration, drainage to ground water, and daily outflows, water, and residual pollutant levels in retention basins or wetland systems (Omicron Associates, 1990). The model can be used to evaluate user-specified alternative control strategies, and it simulates stream segment load capacities in an attempt to develop point source wasteload allocations and nonpoint source load allocations. Probability distributions for runoff and nutrient loadings can be calculated by the model based on either single-event or continuous simulations. The model can be applied in urban, agricultural, or complex watershed simulations. SITEMAP operates within the Lotus 1-2-3 programming environment and is capable of producing graphical output. Although this model requires a minimum calibration effort, it requires moderate effort to prepare input data files. The current version of the program considers only nutrient loading; sediment and other pollutants are not yet incorporated into the program. The model is easily interfaced with GIS (ARC/INFO) to facilitate preparation of land use files. SITEMAP has been applied as a component of a full watershed model to the Tualatin River basin for the Oregon Department of Environmental Quality, and to the Fairview Creek watershed for the Metropolitan Service District in Portland, Oregon.

#### ■ **Generalized Watershed Loading Functions Model**

The GWLF model was developed at Cornell University to assess the point and nonpoint loadings of nitrogen and phosphorus from urban and agricultural watersheds, including septic systems, and to evaluate the effectiveness of certain land use management practices (Haith et al., 1992). One advantage of this model is that it was written with the express purpose of requiring no calibration, making extensive use of default parameters. The GWLF model includes rainfall/runoff and erosion and sediment generation components, as well as total and dissolved nitrogen and phosphorus loadings. The current version of this model does not account for loadings of toxics and metals. The GWLF model uses daily time steps and allows analysis of annual and seasonal time series. The model also uses simple transport routing based on the delivery ratio concept. In addition, simulation results can be used to identify and rank pollution sources and evaluate basinwide management programs and land use changes. The most

recent update of the model incorporates a septic (onsite waste water disposal) system component. The model also includes several reporting and graphical representations of simulation output to aid in interpretation of the results. This model was successfully tested on a medium-sized watershed in New York (Haith and Shoemaker, 1987). A version of the model with an enhanced user interface and linkages to national databases, the Watershed Screening Model has recently become available and is distributed with EPA's Office of Wetlands, Oceans and Watersheds Watershed Screening and Targeting Tool.

#### ■ **Urban Catchment Model (P8-UCM)**

The P8-UCM program was developed for the Narragansett Bay Project to simulate the generation and transport of storm water runoff pollutants in small urban catchments and to assess impacts of development on water quality with minimum site-specific data. It includes several routines for evaluating the expected removal efficiency for particular site plans, selecting or siting BMPs necessary to achieve a specified level of pollutant removal, and comparing the relative changes in pollutant loads as a watershed develops (Palmstrom and Walker, 1990). Default input parameters can be derived from NURP data and are available as a function of land use, land cover, and soil properties. However, without calibration, the use of model results should be limited to relative comparisons. Spreadsheet-like menus and online help documentation make extensive user interface possible. On-screen graphical representations of output are developed for a better interpretation of simulation results. The model also includes components for performing monthly or cumulative frequency distributions for flows and pollutant loadings.

#### ■ **Automated Q-ILLUDAS (AUTO-QI)**

AUTO-QI is a watershed model developed by the Illinois State Water Survey to perform continuous simulations of storm water runoff from pervious and impervious urban lands (Terstriep et al., 1990). It also allows the examination of storm events or storm sequence impacts on receiving water. Critical events also are identified by the model. However, hourly weather input data are required. Several pollutants, including nutrients, chemical oxygen demand, metals, and bacteria, can be analyzed simultaneously. This model also includes a component to evaluate the relative effectiveness of BMPs. An updated version of AUTO-QI, with an improved user interface and linkage to a GIS (ARC/INFO on PRIME computer), has been completed by the Illinois State Water Survey. This interface is provided to generate the necessary input files related to land use, soils, and control measures. AUTO-QI was verified on the Boneyard Creek in Champaign, Illinois, and applied to the Calumet and Little Rivers to determine annual pollutant loadings.

#### ■ **Agricultural Nonpoint Source Pollution Model (AGNPS)**

Developed by the U.S. Department of Agriculture (USDA) Agricultural Research Service, AGNPS addresses concerns related to the potential impacts of point and nonpoint source pollution on water quality (Young et al., 1989). It was designed to quantitatively estimate pollution loads from agricultural watersheds and to assess the relative effects of alternative management programs. The model simulates surface water runoff along with nutrient and sediment constituents associated with agricultural nonpoint sources, as well as point sources such as feedlots, waste water treatment plants, and stream bank or gully erosion. The available version of AGNPS is event based; however, a continuous version is under active development (Needham and Young, 1993). The structure of the model consists of a square grid cell system to represent the spatial distribution of watershed properties. This grid system allows the model to be connected to other software such as GIS and digital elevation models. This connectivity can facilitate

the development of a number of the model's input parameters. Two new terrain-enhanced versions of the model—AGNPS-C, a contour-based version, and AGNPS-G, a grid-based version—have been developed to automatically generate the grid network and the required topographic parameters (Panuska et al., 1991). Vieux and Needham (1993) describe a GIS-based analysis of the sensitivity of AGNPS predictions to grid-cell size. Engel et al. (1993) present GRASS-based tools to assist with the preparation of model inputs and visualization and analysis of model results. Tim and Jolly (1994) used AGNPS with ARC/INFO to evaluate the effectiveness of several alternative management strategies in reducing sediment pollution in a 417-hectare watershed in southern Iowa. The model also includes enhanced graphical representations of input and output information.

#### ■ **Source Loading and Management Model (SLAMM)**

The SLAMM model (Pitt, 1993) can identify pollutant sources and evaluate the effects of a number of different storm water control practices on runoff. The model performs continuous mass balances for particulate and dissolved pollutants and runoff volumes. Runoff is calculated by a method developed by Pitt (1987) for small storm hydrology. Runoff is based on rainfall minus initial abstraction and infiltration and is calculated for both pervious and impervious areas. Triangular hydrographs, parameterized by a statistical approach, are used to simulate flow. Exponential buildup and rain washoff and wind removal functions are used for pollutant loadings. Water and sediment from various source areas are tracked by source area as they are routed through various treatment devices. The program considers how particulates filter or settle out in control devices. Particulate removal is calculated based on the design characteristics of the basin or other removal device. Storage and overflow of devices also are considered. At the outfall locations, the characteristics of the source areas are used to determine pollutant loads in solid and dissolved phases. Loads from various source areas are summed. SLAMM has been used in conjunction with a receiving water quality model (Hydrological Simulation Program—FORTRAN, HSPF) to examine the ultimate effects on urban runoff from Toronto for the Ontario Ministry of the Environment. SLAMM also was used to evaluate control options for controlling urban runoff in Madison, Wisconsin, using GIS information (Thum et al., 1990). The State of Wisconsin uses SLAMM as part of its Priority Watershed Program. It was used in Portland, Oregon, for a study evaluating combined sewer overflows.

## ***2. Detailed Watershed Loading Models***

Detailed models best represent the current understanding of watershed processes affecting pollution generation. Detailed models are best able to identify causes of problems rather than simply describe overall conditions. If properly applied and calibrated, detailed models can provide relatively accurate predictions of variable flows and water quality at any point in a watershed. The additional precision they provide, however, comes at the expense of considerable time and resource expenditure.

Detailed models use storm event or continuous simulation to predict flow and pollutant concentrations for a range of flow conditions. The models are large and were not designed with emphasis on their potential use by the typical state or local planner. Many of these models were developed to research the fundamental land surface and instream processes that influence runoff and pollutant generation rather than to communicate information to decisionmakers faced with planning watershed management.

Detailed models incorporate the manner in which watershed processes change over time in a continuous fashion rather than rely on simplified terms for rates of change (Addiscott and Wagenet, 1985). They tend to require rate parameters for flow velocities and pollutant accumulation, settling, and

decay instead of capacity terms. The length of time steps is variable and depends on the stability of numerical solutions as well as the response time for the system (Nix, 1991). Algorithms in detailed models more closely simulate the physical processes of infiltration, runoff, pollutant accumulation, instream effects, and ground water/surface water interaction. The input and output of detailed models also have greater spatial and temporal resolution. Moreover, the manner in which physical characteristics and processes differ over space is incorporated within the governing equations (Nix, 1991). Linkage to biological modeling is possible because of the comprehensive nature of continuous simulation models. In addition, detailed hydrologic simulations can be used to design potential control actions.

These models use small time steps to allow for continuous and storm event simulations. However, input data file preparation and calibration require professional training and adequate resources. Some of these models (e.g., STORM, SWMM, ANSWERS) were developed not only to support planning-level evaluations but also to provide design criteria for pollution control practices. If appropriately applied, state-of-the-art models such as HSPF and SWMM can provide accurate estimations of pollutant loads and the expected impacts on water quality. New interfaces developed for HSPF and SWMM, and links with GISs, can facilitate the use of complex models for environmental decisionmaking. However, their added accuracy might not always justify the amount of effort and resources they require. Application of such detailed models is more cost-effective when used to address complex situations or objectives.

Selected detailed models are described below.

#### ■ **Storage, Treatment, Overflow Runoff Model (STORM)**

STORM is a U.S. Army Corps of Engineers model developed for continuous simulation of runoff quantity and quality, including sediments and several conservative pollutants. It also simulates combined sewer systems (Hydrologic Engineering Center, 1977). STORM has been widely used for planning and evaluation of the tradeoffs between treatment and storage control options for combined sewer overflows. Long-term simulations of runoff quantity and quality can be used for the construction of duration-frequency diagrams. These diagrams are useful in developing urban planning alternatives and designing structural control practices. STORM was primarily designed for modeling storm water runoff from urban areas. It requires relatively moderate to high calibration and input data. STORM was initially developed for mainframe computer usage; however, several versions have been adapted by various individual consultants for use on microcomputers. The model has been applied recently to water quality planning in the city of Austin, Texas (Pantalion et al., 1995).

#### ■ **Areal Nonpoint Source Watershed Environment Response Simulation Model (ANSWERS)**

ANSWERS is a comprehensive model developed at the University of Georgia to evaluate the effects of land use, management schemes, and conservation practices or structures on the quantity and quality of water from both agricultural and nonagricultural watersheds (Beasley, 1986). The distributed structure of this model allows for a better analysis of the spatial as well as temporal variability of pollution sources and loads. It was initially developed on a storm event basis to enhance the physical description of erosion and sediment transport processes. Data file preparation for the ANSWERS program is rather complex and requires mainframe capabilities, especially when dealing with large watersheds. The output routines are quite flexible; results may be obtained in several tabular and graphical forms. The program has been used to evaluate management practices for agricultural watersheds and construction sites in Indiana. It has been combined with extensive monitoring programs to evaluate the relative importance of point and nonpoint source contributions to Saginaw Bay. This application involved the computation of

unit area loadings under different land use scenarios for evaluation of the tradeoffs between load allocations and wasteload allocations. Recent model revisions include improvements to the nutrient transport and transformation subroutines (Dillaha et al., 1988). Bouraoui et al. (1993) describe the development of a continuous version of the model.

#### ■ **Multi-Event Urban Runoff Quality Model (DR3M-QUAL)**

DR3M is a watershed model for routing storm runoff through a branched system of pipes and/or natural channels using rainfall as input. The model provides detailed simulation of storm runoff periods selected by the user and a daily soil moisture accounting between storms. Kinematic wave theory is used for routing flows over contributing overland flow areas and through the channel network. Storm hydrographs may be saved for input to DR3M-QUAL, which simulates the quality of surface runoff from urban watersheds. The model simulates impervious areas, pervious areas, and precipitation contributions to runoff quality, as well as the effects of street sweeping and/or detention storage. Variations of runoff quality are simulated for user-specified storm runoff periods. Between these storms, a daily accounting of the accumulation and washoff of water-quality constituents on effective impervious areas is maintained. Input to the model includes the storm hydrographs, usually from DR3M. The program has been reviewed extensively within the USGS and applied to several urban modeling studies (Brabets, 1986; Guay, 1990; Lindner-Lunsford and Ellis, 1987).

#### ■ **Simulation for Water Resources in Rural Basins—Water Quality (SWRRBWQ)**

The SWRRBWQ model was adapted from the field-scale CREAMS model by USDA to simulate hydrologic, sedimentation, nutrient, and pesticide movement in large, complex rural watersheds (Arnold et al., 1989). SWRRBWQ uses a daily time step to evaluate the effect of management decisions on water, sediment yields, and pollutant loadings. The processes simulated within this model include surface runoff, percolation, irrigation return flow, evapotranspiration, transmission losses, pond and reservoir storage, sedimentation, and crop growth. The model is useful for estimating the order of magnitude of pollutant loadings from relatively small watersheds or watersheds with fairly uniform properties. Input requirements are relatively high, and experienced personnel are required for successful simulations. SWRRBWQ was used by the National Oceanic and Atmospheric Administration to evaluate pollutant loadings to coastal estuaries and embayments as part of its national Coastal Pollution Discharge Inventory. The model has been run for all major estuaries on the East Coast, West Coast, and Gulf Coast for a wide range of pollutants (Donigian and Huber, 1991). Although SWRRBWQ is no longer under active development, the technology is being incorporated into the Soil and Water Assessment Tool as part of the Hydrologic Unit Model for the United States project at Temple, Texas (Arnold et al., 1993; Srinivasan and Arnold, 1994). EPA's Office of Science and Technology (OST) recently developed a Microsoft Windows-based interface for SWRRBWQ to allow convenient access to temperature, precipitation, and soil data files.

#### ■ **Storm Water Management Model (SWMM)**

SWMM is a comprehensive watershed-scale model developed by EPA (Huber and Dickinson, 1988). It was initially developed to address urban storm water and assist in storm event analysis and derivation of design criteria for structural control of urban storm water pollution, but it was later upgraded to allow continuous simulation and application to complex watersheds and land uses. SWMM can be used to model several types of pollutants provided that input data are available. Recent versions of the model can be used for either continuous or storm event simulation with user-specified variable time steps. The model is relatively data intensive and requires special effort for validation and calibration. Its application

in detailed studies of complex watersheds might require a team effort and highly trained personnel. SWMM has been applied to address various urban water quantity and quality problems in many locations in the United States and other countries (Donigian and Huber, 1991; Huber, 1992). In addition to developing comprehensive watershed-scale planning, typical uses of SWMM include predicting combined sewer overflows, assessing the effectiveness of BMPs, providing input to short-time-increment dynamic receiving water quality models, and interpreting receiving water quality monitoring data (Donigian and Huber, 1991). Warwick and Tadepalli (1991) describe calibration and verification of SWMM on a 10-square-mile urbanized watershed in Dallas, Texas. Tsihrintzis et al. (1995) describe SWMM applications to four watersheds in South Florida representing high- and low-density residential, commercial, and highway land uses. Ovbiebo and She (1995) describe another application of SWMM in a subbasin of the Duwamish River, Washington. OST distributes a Microsoft Windows interface for SWMM that makes the model more accessible. A postprocessor allows tabular and graphical display of model results and has a special section to help with model calibration.

#### ■ Hydrological Simulation Program—FORTRAN (HSPF)

HSPF is a comprehensive package developed by EPA for simulating water quantity and quality for a wide range of organic and inorganic pollutants from agricultural watersheds (Bicknell et al., 1993). The model uses continuous simulations of water balance and pollutant generation, transformation, and transport. Time series of the runoff flow rate, sediment yield, and user-specified pollutant concentrations can be generated at any point in the watershed. The model also includes instream quality components for nutrient fate and transport, biological oxygen demand, dissolved oxygen, pH, phytoplankton, zooplankton, and benthic algae. Statistical features are incorporated into the model to allow for frequency-duration analysis of specific output parameters. Data requirements for HSPF are extensive, and calibration and verification are recommended. The program is maintained on IBM microcomputers and DEC/VAX systems. Because of its comprehensive nature, the HSPF model requires highly trained personnel. It is recommended that its application to real case studies be carried out as a team effort. The model has been extensively used for both screening-level and detailed analyses. HSPF is being used by the Chesapeake Bay Program to model total watershed contributions of flow, sediment, nutrients, and associated constituents to the tidal region of the Bay (Donigian et al., 1990; Donigian and Patwardhan, 1992). Moore et al. (1992) describe an application to model BMP effects on a Tennessee watershed. Scheckenberger and Kennedy (1994) discuss how HSPF can be used in subwatershed planning. Ball et al. (1993) describe an application of HSPF in Australia. Lumb et al. (1990) describe an interactive program for data management and analysis that can be effectively used with HSPF. Lumb and Kittle (1993) present an expert system that can be used for calibration and application of HSPF.

## Using the Walker BATHTUB Model in Lake Pepin, Minnesota

BATHTUB was developed for modeling reservoir water quality and is based on empirical data from U.S. Army Corps of Engineers' reservoirs (Walker, 1986). BATHTUB is routinely used in Clean Water Partnership (CWP) nonpoint source studies and for determining the need for effluent-P limitations in Minnesota. The CWP studies are similar to Clean Lakes Phase I studies and are typically designed to obtain accurate estimates of water and P loading from a lake's major subwatersheds. FLUX, a data reduction tool, is used to reduce flow and concentration data and provide accurate estimates of average flow and concentration (typically flow-weighted means) for the period of concern (typically one water year). Flow-weighted mean concentrations and flow data are used in BATHTUB. BATHTUB allows for segmentation of a lake or reservoir and can be used to route flows and loads between a series of lakes, thus accounting for upstream sedimentation. BATHTUB, Version 5.3 (Walker, 1996) also allows estimation of internal phosphorus loading.

In the absence of monitored data (e.g., small subwatersheds) phosphorus loading may be estimated based on land use composition of the subwatershed, runoff coefficients, and literature-based phosphorus concentrations for a specific land use (e.g. Walker, 1985b). This is often the case when determining effluent-phosphorus limits where detailed loading data are seldom available. In many instances with small dischargers (typically less than 1 MGD) some in-lake data are available, plant discharge is known, and background watershed phosphorus loading is estimated. BATHTUB is then used to determine the "effect" of the discharge on the lake and the need for an effluent-P limitation (typically 1 mg P/L) on the discharge to protect the condition of the lake.

BATHTUB was used to help establish a chlorophyll *a* goal for Lake Pepin, a run-of-the-river reservoir on the Mississippi River between Minnesota and Wisconsin (Heiskary and Walker, 1995). A major interagency study of Lake Pepin and the Mississippi River was initiated in 1990 in response to major nuisance algal blooms, which occurred during the low-flow summer of 1988, and to assess the impact of the 250 MGD Metropolitan Council's Metro wastewater treatment facility located 80 kilometers upstream of the lake. In Lake Pepin inorganic turbidity and flow, in addition to phosphorus, strongly influence chlorophyll *a* concentrations. By choosing a model subroutine which accounted for these factors, reliable estimates of chlorophyll *a*, as a function of flow (residence time) and inflow phosphorus concentration were made. In turn, the in-lake phosphorus concentration required to achieve the chlorophyll *a* goal of 30 µg/L (and thus minimize the frequency of severe nuisance blooms) over a range in flow conditions was estimated. The flows of concern in this case ranged from about 4,600 cfs (2% reoccurrence) up to about 20,000 cfs (50% reoccurrence). A flow of 20,000 cfs corresponded to a residence time of about 11 days in Lake Pepin. Concurrent modeling of Lake Pepin by the Metropolitan Council using WASP provided comparable results (Lung and Larson, 1995).

Both modeling efforts raised questions about the role of internal loading in this system and to what degree internal loading might inhibit recovery of the system (even with substantial reductions in external loading). Subsequent permit negotiations led to (1) interim phosphorus limits at the Metro Plant; (2) provisions to pursue bio-phosphorus removal in a portion of the plant; and (3) further modeling of Lake Pepin and the Mississippi River to better understand the relationship between external loading, internal recycling, and the production of algae in the reservoir. More recent permit negotiations (1998-99) led to permanent phosphorus limits for the Metro Plant that will be accomplished through biological phosphorus removal. Detailed mechanistic modeling, conducted as a requirement of the previous permit, provided an improved understanding of this complex run-of-the-river reservoir. However, questions remained on the magnitude of internal loading and how this might influence the overall recovery of this system with reductions in external P loading.



## CASE STUDY: The Minnesota Approach to Lake Eutrophication Modeling

The Minnesota Pollution Control Agency (MPCA) uses a suite of models in the course of lake eutrophication studies. Applications include: goal setting during Lake Assessment Program (LAP) studies; defining water and nutrient mass-balances during nonpoint source (Clean Water Partnership) studies; and establishing effluent-phosphorus limits for municipal and industrial wastewater discharges to lakes. The choice of model is dictated by the availability of data and the degree of precision required in the modeling estimate. For example, the establishment of effluent phosphorus limits for large dischargers requires greater precision than is required for a simple goal-setting exercise. The suite of models used by MPCA include (1) a simple regression model for predicting background phosphorus concentrations, (2) an ecoregion-based model, (3) spreadsheet methodologies based on the Reckhow and Simpson (1980) technique, (4) the BATHTUB model, and (5) mechanistic applications such as WASP. All of these models have been used as a basis for goal setting and can also be used to develop nutrient criteria, to predict whether lakes may achieve certain criteria levels, or to determine how point or nonpoint sources of phosphorus may impact a lake.

A regression model developed by Vighi and Chiaudani (1985), which is based on the morphoedaphic index (commonly used in fishery science), is frequently used in Minnesota to estimate background TP for lakes during LAP studies. The regression equation predicts TP based on lake morphometry (mean depth) and alkalinity or conductivity and provides a quick estimate of background phosphorus concentrations for a lake. When used in conjunction with reference-lake data sets and other models it can be very useful for goal setting. It may also be particularly useful for developing phosphorus criteria in regions where background conditions are assumed to be naturally oligotrophic to mesotrophic because the model-development data set is based on oligotrophic and mesotrophic lakes. This model is best used in conjunction with other tools and data sets and may be of limited value for goal setting in very shallow lakes, lakes with excessive internal loading, or lake/reservoir chains.

The "Minnesota Lake Eutrophication Analysis Procedures" (MINLEAP), was developed by MPCA staff based on an analysis of data collected from the reference lakes in each of Minnesota's ecoregions. It is intended to be used as a screening tool for estimating lake conditions with minimal input data (lake mean depth and surface area, watershed area, ecoregion, and some observed data for comparison). MINLEAP is described in greater detail in Wilson and Walker (1989). Routine data from minimally-impacted streams in each ecoregion are used as one basis for estimating inflow TP concentrations. Annual precipitation, evaporation, and runoff are summarized based on Minnesota Department of Natural Resources and USGS data and regionalized for use in the model (Wilson, 1990). The model predicts in-lake phosphorus concentrations based on the Canfield and Bachmann (1981) natural lake equation. Chlorophyll *a* and Secchi are estimated based on regression equations developed from the ecoregion-reference lake data set. In addition, nuisance frequencies of chlorophyll *a* are predicted based on equations developed by Walker (1985a). These nuisance frequency predictions are particularly useful for communicating the impact of increasing in-lake phosphorus concentrations to lake users and local governments.

The MINLEAP procedure has been extremely useful for quickly screening lake condition and as a basis for goal setting. The Vighi and Chiaudani regression is built into the model and allows for comparisons between the two methodologies. The MINLEAP model tends to work best for headwater lakes or lakes with moderate-sized watersheds. The model will tend to over-predict in-lake phosphorus concentrations for lakes with large watersheds or for chains of lakes, since upstream sedimentation is not specifically incorporated into the model. The program was originally written in BASIC but has been converted for use in Windows, thus increasing its utility and making it potentially adaptable for additional ecoregions or for use in other states.

The next level of modeling routinely employed by Minnesota is the Reckhow and Simpson spreadsheet model. This spreadsheet is based on Reckhow and Simpson (1980) and underlying concepts are discussed in greater detail in Wilson (1990). This model relies on phosphorus export coefficients and land uses as a basis for estimating phosphorus loading to a lake. Runoff coefficients and regional precipitation and evaporation data are used to estimate the lake water budget. This type of model can be useful for estimating the impact of changes in land use and making general estimates of the relative contributions to the in-lake phosphorus concentration from a variety of sources such as the watershed (e.g., soils), precipitation, and shoreland septic systems. The accuracy of the estimates is dependent on good land use data, appropriate phosphorus export coefficients for the region, and reliable in-lake data to initially test the model.

Appropriate phosphorus export coefficients are often a shortcoming of the Reckhow and Simpson technique. This is especially true for lakes with large watersheds and/or lakes which have extensive lake or wetland areas in their watershed. In these instances, routinely published export coefficients will often overestimate actual phosphorus loading and produce unreliable estimates. Prairie and Kalf (1986) provide some regression equations that account for the size of the watershed, predominant land use, and the retention of phosphorus that occurs in large watersheds. This often yields more reasonable export estimates.

The MPCA version of the Reckhow-Simpson spreadsheet was modified by Wilson to include a methodology which allows for an estimate of the potential loading from feedlots in the watershed (Heiskary and Wilson, 1996). This analysis is based on estimates

of animal units and literature estimates of phosphorus generated per animal. This feature is useful in watersheds with extensive feedlots or pasturing operations since routinely cited phosphorus exports for “pastured use” do not typically account for the high phosphorus exports arising from feedlots (Shuler, 1995). Although a spreadsheet model of this type may have many shortcomings, it often is the only readily available model that can be used to estimate land use changes in the watershed when data are very limited (as is often the case for local governments needing to assess the impact of small scale land use changes on the quality of a lake).

Several other methodologies are somewhat similar to that described here but more widely available and may be useful for developing or testing nutrient criteria or assessing the impact of land use changes in a lake’s watershed. Prominent among these would be EUTROMOD (Reckhow, 1990) and the Wisconsin Lake Model Spreadsheet (WILMS; Panuska et al., 1994). These two models and related models for assessing the impact of development in a watershed (such as Pondnet and Pondsiz) are readily available from the North American Lake Management Society (Phone: 608-233-2836).

## REFERENCES

- Addiscott TM, Wagenet RJ. 1985. Concepts of solute leaching in soils: A review of modeling approaches. *J Soil Sci* 36:411-424.
- Ambrose RB, Barnwell TO, McCutcheon SC, et al. 1995. Computer models for water quality analysis. In *Handbook of water resources*. New York: McGraw-Hill.
- Ameel JJ, Axler RP, Owen CJ. 1993. Persulfate digestion for determination of total nitrogen and phosphorus in low-nutrient waters. *Am Environ Lab* 10:1-11.
- American Public Health Association. 1995. *Standard methods for the examination of water and wastewater*. 19th ed. Washington, DC.
- American Public Health Association. 1998. *Standard methods for the examination of water and wastewater*. 20th ed. Washington, DC.
- Arnold JG, Engel BA, R Srinivasan R. 1993. A continuous time, grid cell watershed model. In: *Proceedings of Application of Advanced Information Technologies for the Management of Natural Resources*, sponsored by ASAE, June 17-19, 1993, Spokane, WA.
- Arnold JG, Williams JR, Nicks AD, et al. 1989. SWRRB, a basin scale simulation model for soil and water resources in rural basins. *J Water Res Plan Manage* 113(2):243-256.
- Ball JE, White MJ, Innes G de R, et al. 1993. Application of HSPF on the Upper Nepean Catchment. In: *Proceedings of Hydrology and Water Resources Symposium*, Newcastle, New South Wales, Australia, June 30-July 2, 1993, pp. 343-348.
- Bannerman R, Owens D, Dodds R, et al. 1993. Sources of pollutants in Wisconsin stormwater. *Water Sci Technol* (28)3-5:241-259.
- Beasley DB. 1986. Distributed parameter hydrologic and water quality modeling. In: Giorgini, Zingales E, eds. *Agricultural nonpoint source pollution: Model selection and application*, pp. 345-362.
- Bicknell BR, Imhoff JC, Kittle JL, et al. 1993. *Hydrological Simulation Program - FORTRAN (HSPF): User's manual for release 10.0*. U.S. Environmental Protection Agency, Environmental Research Laboratory, Athens, GA. EPA 600/3-84-066.
- Bouraoui E, Dillaha TA, Mostaghimi S. 1993. ANSWERS 2000: Watershed model for sediment and nutrient transport. ASAE Paper No. 93-2079. American Society of Agricultural Engineers, St. Joseph, MI.
- Brabets TP. 1986. Quantity and quality of urban runoff from the Chester Creek Basin, Anchorage, Alaska. *Water Resources Investigations Report 86-4312*. U.S. Geological Survey, Denver, CO.
- Brezonik PL, Shannon EE. 1971. Trophic state of lakes in north central Florida. *Research Project Technical Completion Report*. OWRR Project No. B-004-FLA., Publ. No. 13. Water Research Center, University of Florida.

- Camp, Dresser, and Mckee (CDM). 1992. Watershed Management Model user's manual, version 2.0. Prepared for the Florida Department of Environmental Regulation, Tallahassee, FL.
- Canale RP, Hinemann DF, Nachippan S. 1974. A biological production model for Grand Traverse Bay. University of Michigan Sea Grant Program, Technical Report No. 37, Ann Arbor, MI.
- Canfield D, Bachmann R. 1981. Prediction of total phosphorus concentrations, chlorophyll-a, and Secchi depths in natural and artificial lakes. *Can. J Fish Aquat Sci* 38:414-423.
- Canfield DE. 1983. Prediction of chlorophyll *a* concentrations in Florida lakes: The importance of phosphorus and nitrogen. *Water Res Bull* 19:255-262.
- Canfield DE Jr. 1983. Impact of integrated aquatic weed management on water quality in a citrus grove. *J Aquat Plant Manage* 21:69-73.
- Canfield DE Jr, Langeland KA, Maceina MJ, et al. 1983. Trophic state classification of lakes with aquatic macrophytes. *Can J Fish Aquat Sci* 40:1713-1718.
- Carlson RE. 1977. A trophic state index for lakes. *Limnol Oceanogr* 22:361-369.
- Carlson RE. 1980. More complications in the chlorophyll-Secchi disk relationship. *Limnol Oceanogr* 25(2):379-382.
- Carlson RE. 1983. Discussion: Using differences among Carlson' trophic state index values in regional water quality assessment, by Richard A. Osgood. *Water Res Bull* 19(2):307-309.
- Carlson RE. 1991. Expanding the trophic state concept to identify non-nutrient limited lakes and reservoirs. In: *Enhancing the State's lake management programs: Proceedings of a conference, Chicago, 1991*, North American Lake Management Society, pp. 59-71.
- Carlson RE. 1992. Expanding the trophic state concept to identify non-nutrient limited lakes and reservoirs. In: *Proceedings of a National Conference on Enhancing the States' Lake Management Programs, Monitoring and Lake Impact Assessment, Chicago*. pp. 59-71.
- Carlson RE, Simpson J. 1996. A coordinator's guide to volunteer lake monitoring methods. North American Lake Management Society, Madison, WI.
- Carpenter SR, Lodge DM. 1986. Effects of submersed macrophytes on ecosystem processes. *Aquat Bot* 341-370.
- Chapra S, Canale RR. 1991. Long-term phenomenological model of phosphorus and oxygen for stratified lakes. *Water Res* 25(6):707-715.
- Chapra SC. 1975. Comment on An empirical method of estimating the retention of phosphorus in lakes by Kirchner WB, Dillon PJ. *Water Res* 11(6):1033-1034.
- Chapra SC. 1979. Applying phosphorus loading models to embayments. *Limnol Oceanogr* 24:163-168.

Chen CW, Orlob GT. 1975. Ecological simulation for aquatic environments. In: Patton BC, ed. *Systems analysis and simulation in ecology*. Vol. III. New York: Academic Press, p. 475.

Chapra SC, Tarapchak SJ. 1976. A chlorophyll a model and its relationship to phosphorus loading plots for lakes. *Water Res* 12(6):1260-1264.

Chen CW, Orlob GT. 1975. Ecological simulation for aquatic environments. In: Patton BC, ed. *Systems analysis and simulation in ecology*. Vol. III. New York: Academic Press, p. 475.

Clark WC, Jones DD, Holling CS. 1979. Lessons for ecological policy design: A case study of ecosystem management. *Ecol Model* 7:1-53.

Cornett RJ, Rigler FH. 1979. Hypolimnetic oxygen deficits: Their prediction and interpretation. *Science* 205:580-581.

D'Elia CF, Steudler PA, Corwin N. 1977. Determination of total nitrogen in aqueous samples using persulfate digestion. *Limnol Oceanogr* 22:760-764.

Dillaha, TA. 1992. Nonpoint source modelling for evaluating the effectiveness of best management practices. *NWQEP Notes* 52(March):5-7.

Dillon PJ, Rigler FH. 1975. A simple method for predicting the capacity of a lake for development based on lake trophic status. *J Fish Res Board Can* 31(9):1519-1531.

Donigian AS Jr, Bicknell BR, Linker LC, et al. 1990. Chesapeake Bay Program Watershed Model application to calculate bay nutrient loadings: Preliminary Phase I findings and recommendations. Prepared for the U.S. Chesapeake Bay Program, Annapolis, MD, by AQUA TERRA Consultants.

Donigian AS, Huber WC. 1991. Modeling of nonpoint source water quality in urban and non-urban areas. U.S. Environmental Protection Agency, Washington, DC. EPA/600/3-91/039.

Donigian AS Jr, Patwardhan AS. 1992. Modeling nutrient loadings from croplands in the Chesapeake Bay Watershed. In: *Proceedings of water resources sessions at Water Forum '92*, Baltimore, MD, August 2-6, 1992, pp. 817-822.

Ebina J, et al. 1983. Simultaneous determination of total nitrogen and total phosphorus in water using peroxydisulfate oxidation. *Water Res* 17:1721-1726.

Edmondson WT. 1961. Changes in Lake Washington following an increase in the nutrient income. *Verhandl Int Verein Theoret Angew Limnol* 14:167-175.

Edmondson WT. 1972. Nutrients and phytoplankton in Lake Washington. In: Likens GE, ed., *Nutrients and eutrophication*. Lawrence, KS: American Society of Limnology and Oceanography, pp. 172-193.

Elser JJ, Marzolf ER, Goldman CR. 1990. Phosphorus and nitrogen limitation of phytoplankton growth in the freshwaters of North America: A review and critique of experimental enrichments. *Can J Fish Aquat Sci* 47:1468-1477.

- Engel BA, Srinivasan R, Rewerts C. 1993. Modeling erosion and surface water quality. Geographic Information Systems: Proceedings of the Seventh Annual GRASS Users Conference, Lakewood, CO, March 16-19, 1992. National Park Service Technical Report NPS/NRGISD/NRTR-93/13.
- Ernst MR, Frossard W, Mancini JL. 1994. Two eutrophication models make the grade. *Water Environ Technol* November:15-16.
- Fairweather PG. 1991. Statistical power and design requirements for environmental monitoring. *Aus J Mar Freshwater Res* 42:555-67.
- Federal Highway Administration. 1990. Pollutant loadings and impacts from highway stormwater runoff. U.S. Department of Transportation, Research, Development, and Technology, McLean, VA.
- Ford DE. 1990. Reservoir transport processes. In: Thornton KW, Kimmel BL, Payne FE, eds. *Reservoir limnology: Ecological perspectives*. New York: Wiley-Interscience, pp. 15-41.
- Gerritsen J, Jessup B, Leppo E, et al. 1999. Development and testing of a biological index for Florida lakes. Prepared for Florida Department of Environmental Protection, Tallahassee, FL.
- Gibson G, Wedepohl R, Knauer D. 1983. Lake protection by watershed management for Wisconsin lake districts. Proceedings of the North American Lake Management Society, Vancouver, British Columbia, Canada. EPA 440/5-83-001.
- Gliwicz ZM, Kowalczewski A. 1981. Epilimnetic and hypolimnetic symptoms of eutrophication in Great Mazurian Lakes, Poland. *Freshwater Biol* 11:425-433.
- Griffith GE, Canfield DE Jr, Horsburgh CA, et al. 1997. Lake regions of Florida. Map published by Florida Department of Environmental Protection and U.S. Environmental Protection Agency, Tallahassee, FL.
- Guay JR. 1990. Simulation of urban runoff and river water quality in the San Joaquin River near Fresno, California. In: Symposium Proceedings on Urban Hydrology, American Water Resources Association, Denver, CO, November 4-8, 1990, pp. 177-182.
- Haith DA, Mandel R, Wu RS. 1992. GVVLFF-Generalized Watershed Loading Functions, Version 2.0 User's manual. Cornell University, Department of Agricultural Engineering, Ithaca, NY.
- Haith DA, Shoemaker LL. 1987. Generalized watershed loading functions for stream flow nutrients. *Water Res Bull* 107(EEI):121-137.
- Heiskary S, Lindbloom J, Wilson CB. 1994. Detecting water quality trends with citizen volunteer data. *Lake Reservoir Manage* 9(1):4-9.
- Heiskary SA. 1989. Lake assessment program: A cooperative lake study program. *Lake Reservoir Manage* 5:85-94.
- Heiskary SA, Anhorn R, Noonan T, et al. 1994. Minnesota lake and watershed data collection manual. Environmental Quality Board-Lakes Task Force, Data and Information Committee. Minnesota Lakes Association.

- Heiskary SA, Walker WW Jr. 1988. Developing phosphorus criteria for Minnesota lakes. *Lake Reservoir Manage* 4(1):1-10.
- Heiskary SA, Walker WW Jr. 1995. Establishing a chlorophyll-a goal for a run-of-the-river reservoir. *Lake Reservoir Manage* 11(1):67-76.
- Heiskary SA, Wilson CB. 1988. Minnesota Lake Water Quality Assessment Report. Minnesota Pollution Control Agency, St. Paul.
- Heiskary SA, Wilson CB. 1989. The regional nature of lake water quality across Minnesota: An analysis for improving resource management. *J Minn Acad Sci* 55:71-77.
- Hession WC, Storm DE, Burks SL, et al. 1995. Using EUTROMOD with a GIS for establishing total maximum daily loads to Wister Lake, Oklahoma. In: *Impact of animal waste on the land-water interface*. Lewis Publishers, pp. 53-60.
- Hoyer MV, Jones JR. 1983. Factors affecting the relation between phosphorous and chlorophyll a in midwestern reservoirs. *Can J Fish Aquat Sci* 40:192-199.
- Huber WC. 1992. Experience with the USEPA SWMM Model for analysis and solution of urban drainage problems. In: Dolz J, Gomez M, Martin JP, eds. *Proceedings, Inundaciones Y Redes De Drenaje Urbano*, pp. 199-220. Colegio de ingenieros de Caminos, Canales Y Puertos, Universitat Politecnica de Catalunya, Barcelona, Spain.
- Huber WC, Brezonik PL, Heaney JP. 1982. A classification of Florida lakes. Report to the Florida Department of Environmental Regulation. Report ENV-05-82-1.
- Huber WC, Dickinson RE. 1988. Storm water management model version 4. User's manual. U.S. Environmental Protection Agency, Athens, GA. EPA/600/3-88/001a (NTIS PB88-236641/AS).
- Hurlbert SH. 1984. Pseudoreplication and the design of ecological field experiments. *Ecol Monog* 54(2):187-211.
- Jones JR, Bachmann RW. 1978. Trophic status of Iowa lakes in relation to origin and glacial geology. *Hydrobiologia* 57:267-273.
- Jones JR, Knowlton MF. 1993. Limnology of Missouri reservoirs: An analysis of regional patterns. *Lake Reservoir Manage* 8:17-30.
- Jones JR, Knowlton MF, Swar DB. 1989. Limnological reconnaissance of waterbodies in central and southern Nepal. *Hydrobiologia* 184:171-189.
- Jones JR, Novak JT. 1981. Limnological characteristics of Lake of the Ozarks, Missouri. *Verhandl Int Vereinig Theoret Angew Limnol* 21:919-925.
- Jorgensen SE. 1995. State of the art of ecological modelling in limnology. *Ecol Model* 78(1995):101-115.
- Karr JR. 1981. Assessment of biotic integrity using fish communities. *Fisheries* 6(6):21-27.

Kennedy RH. 1998. Basinwide considerations for water quality management: importance of phosphorus retention by reservoirs. Water Quality Technical Note MS-03, U.S. Army Engineer Waterways Experiment Station, Vicksburg, MS.

Kennedy RH. 1999a. Reservoir design and operation: Limnological implications and management opportunities. In: Tundisi JG, Straskraba M, eds. Theoretical reservoir ecology and its applications. Brazil and the Netherlands: International Institute of Ecology, Brazilian Academy of Sciences, and Backhuys Publishers, pp. 1-28.

Kennedy RH. 1999b. Nutrient criteria: Considerations for Corps of Engineers reservoirs. Water Quality Technical Note, U.S. Army Engineer Waterways Experiment Station, Vicksburg, MS.

Kennedy RH, Walker WW. 1990. Reservoir nutrient dynamics. In: Thornton KW, Kimmel DL, Payne FE, eds. Reservoir limnology: Ecological perspective. New York: John Wiley, pp. 109-131.

Kennedy RH, Thornton KW, Ford D. 1985. Characterization of the reservoir ecosystem. In: Gunnison D, ed. Microbial processes in reservoirs. Boston: Dr. W. Junk Publishers.

Kiilsgaard CW, Rohm CM, Pierson SM, et al. 1993. Total phosphorus regions for lakes in the Northeastern United States. Prepared for ManTech Environmental Technology, Inc., Corvallis, OR, and the U.S. Environmental Protection Agency, Corvallis, OR.

Kimmel BL, Lind OT, Paulson LJ. 1990. Reservoir primary production. In: Thornton KW, Kimmel BL, Payne FE, eds. Reservoir limnology: Ecological perspectives. New York: Wiley-Interscience, pp. 133-193.

Knowlton MF, Jones JR. 1989. Comparison of surfaces and depth integrated composite samples for estimating algal biomass and phosphorus values, and notes on the vertical distribution of autotrophs in Midwestern lakes. Arch Hydrobiol 83 (Suppl):175-196.

Knowlton MF, Jones JR. 1996. Nutrient addition experiments in a nitrogen-limited high plains reservoir where nitrogen-fixing algae seldom bloom. J Freshwater Ecol 11:123-130.

Kratzer CR, Brezonik PL. 1981. A Carlson-type trophic state index for nitrogen in Florida lakes. Water Res Bull 17:713-715.

Laws EA, Chalup MS. 1990. A microalgal growth model. Limnol Oceanogr 35(3):597-608.

Lindner-Lunsford JB, Ellis SR. 1987. Comparison of conceptually based and regression rainfall-runoff models, Denver Metropolitan Area, Colorado, and potential applications in urban areas. Water Resources Investigation Report 87-4104. U.S. Geological Survey, Denver, CO.

Lindner-Lunsford JB, Hutchinson GE. 1957. A treatise on limnology. Vol. 1. Geography, physics, and chemistry. New York: John Wiley.

Linthurst RA, Landers DH, Eilers JM, et al. 1986. Characteristics of lakes in the eastern United States. Vol. 1: Population descriptions and physico-chemical relationships. Office of Research and Development, U.S. Environmental Protection Agency.



Lumb AM, Kittle JL, Flynn KM. 1990. Users manual for ANIVIE, A computer program for interactive hydrologic analyses and data management. Water Resources Investigation Report 89-4080. U.S. Geological Survey, Reston, VA.

Lumb AM, Kittle JL. 1993. Expert system for calibration and application of watershed models. In: Proceedings of the Federal Interagency Workshop on Hydrologic Modeling Demands for the 90's. U.S. Geological Survey Water Resources Investigation Report 93-4018. Fort Collins, CO, June 6-9, 1993.

Martin RG, Arneson RD. 1978. Comparative limnology of a deep-discharge reservoir and a surface-discharge lake on the Madison River, Montana. *Freshwater Biol* 8:33-42.

McCauley E, Downing JA, Watson S. 1989. Sigmoid relationships between nutrients and chlorophyll among lakes. *Can J Fish Aquat Sci* 46:1171-1175.

McCollor S, Heiskary S. 1993. Selected water quality characteristics of minimally impacted streams from Minnesota's seven ecoregions. Minnesota Pollution Control Agency, St. Paul, MN.

McElroy AD, Chiu SW, Nabgen JW, et al. 1976. Loading functions for assessment of water pollution for non-point sources. U.S. Environmental Protection Agency. EPA 600/2-76/151 (NTIS PB-253325).

Meeuwig JJ, Peters RH. 1996. Circumventing phosphorus in lake management: A comparison of chlorophyll *a* predictions from land-use and phosphorus loading models. *Can J Fish Aquat Sci* 53:1795-1806.

Menzel DW, Corwin N. 1965. The measurement of total phosphorus in sea water based on the liberation of organically bound fraction by persulfate oxidation. *Limnol Oceanogr* 10:280-282.

Mills WB, Borcella BB, Ungs MJ, et al. 1985. Water quality assessment. A screening procedure for toxic and conventional pollutants in surface and ground water. Part 1. U.S. Environmental Protection Agency, Environmental Research Laboratory, Athens, GA. EPA/600/6-85/002a.

Moore LW, Chew CY, Smith RH, et al. 1992. Modeling of Best Management Practices on North Reelfoot Creek, Tennessee. *Water Environ Res* 64(3):241-247.

Morris DP, Lewis WM Jr. 1988. Phytoplankton nutrient limitation in Colorado mountain lakes. *Freshwater Biol* 20:315-327.

Mortimer CH. 1941. The exchange of dissolved substances between mud and water in lakes. *J Ecol* 30:147-201.

Moss B, Madgewick J, Phillips G. 1996. A guide to the restoration of nutrient-enriched shallow lakes. Broads Authority, Norwich, UK. 180 pp.

Naumann E. 1929. The scope and chief problems of regional limnology. *Int Revue Ges Hydrobiol* 21:423.

Needham SE, Young, RA. 1993. ANN-AGNPS: A continuous simulation watershed model. In Proceedings of the Federal Interagency Workshop on Hydrologic Modeling Demands for the 90's, Fort Collins, CO, June 6-9, 1993. U.S. Geological Survey Water Resources Investigation Report 93-4018.

- Nix JS. 1991. Applying urban runoff models. *Water Environ Technol* June 1991.
- North American Lake Management Society. 1992. Developing eutrophication standards for lakes and reservoirs. Report prepared by the Lake Standards Subcommittee. Alachua, FL. 51 pp.
- Nurnberg GK. 1996. Trophic state of clear and colored, soft- and hardwater lakes with special consideration of nutrients, anoxia, phytoplankton and fish. *J Lake Reservoir Manage* 12:432-447.
- O'Conner DJ, Thomann RX, Di Toro DM. 1975. Water quality analyses of estuarine systems. In: *Estuaries, geophysics, and the environment*. National Academy of Sciences, Washington, DC.
- Oglesby RT. 1977. Relationships of fish yield to lake phytoplankton standing crop, production, and morphoedaphic factors. *J Fish Res Board Can* 34:(12)2271-2279.
- Oglesby RT, Leach JH, Forney J. 1987. Potential Stizostedion yield as a function of chlorophyll concentration with special reference to Lake Erie. *Can J Fish Aquat Sci* 44(Suppl. 2):166-170.
- Olen H, Flock G, eds. 1990. *Lake and reservoir restoration guidance manual*, 2nd ed. U.S. Environmental Protection Agency. EPA-440/4-90-006.
- O'Melia CR. 1972. An approach to modeling of lakes. *Schweiz Zeitschr Hydrol* 34:1-34.
- Omernik JM. 1976. The influence of land use on stream nutrient levels. U.S. Environmental Protection Agency. EPA-600/3-76-014.
- Omernik JM. 1987. Ecoregions of the conterminous United States. *Ann Assoc Am Geogr* 77(1):118-125.
- Omernik JM. 1995. Ecoregions: A framework for managing ecosystems. *George Wright Forum* 12(1):35-50.
- Omernik JM. 1998. EPA ecoregion map. NHEERL-WED, U.S. Environmental Protection Agency, Corvallis, OR
- Omernik JM, Larsen DP, Rohm CM, et al. 1988. Summer total phosphorus in lakes: A map of Minnesota, Wisconsin, and Michigan. *Environ Manage* 12:815-825.
- Omernik JM, Rohm CM, Clark SE, et al. Summer total phosphorus in lakes: A map of Minnesota, Wisconsin, and Michigan, USA. *Environ Manage* 12(6):815-825.
- Omicron Associates. 1990. Nonpoint pollution source model for analysis and planning (NPSMAP)—Users manual. Omicron Associates, Portland, OR.
- Organization for Economic Co-operation and Development (OECD). 1982. *Eutrophication of waters-- monitoring assessment and control*. OECD, Paris. 154 p.
- Osgood RA. 1988. Lake mixis and internal phosphorous dynamics. *Arch Hydrobiol* 113:629-638.

Ovbiebo T, She N. 1995. Urban runoff quality and quantity modeling in a subbasin of the Duwamish river using XP-SWMM. In: Proceedings of a Symposium, Water Management Planning for the 21st Century, American Society of Civil Engineers, San Antonio, TX, August 14-16, 1995, pp. 320-329.

Palmstrom N, Walker WW Jr. 1990. P8 urban catchment model user's guide, program documentation, and evaluation of existing models, design concepts, and Hunt-Potowomut data inventory. The Narragansett Bay Project Report No. NBP-90-50.

Pantalion J, Scharlach A, Oswald G. 1995. Water quality master planning in an urban watershed. In: Watershed Management: Planning for the 21st Century, proceedings of the ASCE's First International Conference of Water Resources Engineering, San Antonio, TX, August 14-16, 1995, pp. 330-339.

Panuska JC, Moore JD, Kramer LA. 1991. Terrain analysis: Integration into the agricultural nonpoint source (AGNPS) pollution model. *J Soil Water Conserv* 46(1):59-64.

Paulsen SG, Larsen DP, Kaufmann PR, et al. 1991. EMAP - surface waters monitoring and research strategy, fiscal year 1991. U.S. Environmental Protection Agency, Office of Research and Development, Washington, DC, and Environmental Research Laboratory, Corvallis, OR. EPA-600-3-91-002.

Peterman RM. 1990. The importance of reporting statistical power: The forest decline and acidic deposition example. *Ecology* 71:2024-2027.

Peters RH. 1986. The role of prediction in limnology. *Limnol Oceanogr* 31:1143-1159.

Pielou EC. 1977. *Mathematical ecology*. New York: John Wiley.

Pitt R. 1987. Small storm urban flow and particulate washoff contributions to outfall discharges. Ph.D. dissertation, Civil and Environmental Engineering Department, University of Wisconsin, Madison, WI.

Pitt R. 1993. Source loading and management model (SLAMM). Presented at the National Conference on Urban Runoff Management, March 30-April 2, 1993, Chicago, IL.

Prairie YT, Duarte CM, Kalff J. 1989. Unifying nutrient-chlorophyll relationships in lakes. *Can J Fish Aquat Sci* 46:1176-1182.

Prairie YT, Marshall CT. 1995. On the use of structured time-series to detect and test hypotheses about within-lake relationships. *Can J Fish Aquat Sci* 52:799-803.

Prairie YT, Kalff J. 1986. Effect of catchment size on phosphorus export. *Water Res Bull* 22(3):465-470.

Pridmore RD, Vant WN, Rutherford JC. 1985. Chlorophyll-nutrient relationships in North Island Lakes (New Zealand). *Hydrobiologia* 121:181-189.

Quiros R. 1990. Factors related to variance or residuals in chlorophyll-total phosphorus regression in lakes and reservoirs of Argentina. *Hydrobiologia* 200/201:343-355.

Raschke RL. 1994. Phytoplankton bloom frequencies in a population of small Southeastern impoundments. *Lake Reservoir Manage* 8(2):205-210.

- Rast W, Lee GF. 1983. Nutrient loading estimates for lakes. *J Env Eng* 109:502-517.
- Rast W, Lee GF. 1987. Summary analysis of the North American OECD eutrophication project: Nutrient loading-lake response relationships and trophic state indices. U.S. Environmental Protection Agency. EPA 600/3-78-008.
- Rawson DS. 1952. Mean depths and the fish production of large lakes. *Ecology* 33:513-521.
- Rawson DS. 1955. Morphometry as a dominant factor in the productivity of large lakes. *Verhandl Int Verein Theoret Angew Limnol* 12:164-175.
- Reckhow KH, Simpson JT. 1980. A procedure using modeling and error analysis for the prediction of the lake phosphorus concentration from land use information. *Can J Fish Aquat Sci* 37:1439-1448.
- Reynolds CS. 1997. Vegetative processes in the Pelagic: A model for ecosystem theory. Ecology Institute, Oldendorf/Luhe, Germany. 371 p.
- Reynolds CS, Walsby AE. 1975. Water blooms. *Biol Rev* 50:437-481.
- Riley ET, Prepas EE. 1985. Comparison of the phosphorus-chlorophyll relationships in mixed and stratified lakes. *Can J Fish Aquat Sci* 42 (4):831-835.
- Rodhe W. 1969. Crystallization of eutrophication concepts in northern Europe. In: *Eutrophication: Causes, consequences, correctives*. National Academy of Sciences, pp. 50-64.
- Rohm CM, Omernik JM, Kilsgaard CW. 1995. Regional patterns of total phosphorous in lakes of the northeastern United States. *Lake Reservoir Manage* 11:1-14.
- Ryder RA. 1965. A method for estimating the potential fish production of north-temperate lakes. *Trans Am Fish Soc* 94:214-218.
- Ryding SO, Rast W. 1989. The control of eutrophication of lakes and reservoirs. *Man and the Biosphere Series*, United Nations Educational Scientific and Cultural Organization, Paris, France. 314 pp.
- Sakamoto M. 1966. Primary production of phytoplankton community in some Japanese lakes and its dependence on lake depth. *Arch Hydrobiol* 62:1-28.
- Sawyer CN. 1947. Fertilization of lakes by agricultural and urban drainage. *N Engl Water Works Assoc* 61:109-127.
- Scheckenberger RB, Kennedy AS. 1994. The use of HSPF in subwatershed planning. In: James W, ed. *Current practices in modelling the management of stormwater impacts*. Boca Raton, FL: Lewis Publishers, pp. 175-187.
- Scheffer M. 1989. Alternative stable states in eutrophic shallow freshwater systems: A minimal model. *Hydrobiol Bull* 23:73-85.
- Scheffer M, Hosper SH, Meijer M-L, et al. 1993. Alternative equilibria in shallow lakes. *Trend Ecol Evolut* 8:275-279.

- Schindler DW. 1977. Evolution of phosphorus limitations in lakes. *Science* 195:260-262.
- Schindler DW. 1978. Factors regulating phytoplankton production and standing crop in the world's freshwaters. *Limnol Oceanogr* 23:478-486.
- Schueler T. 1987. Controlling urban runoff. A practical manual for planning and designing urban BMPs. Metropolitan Washington Council of Governments, Washington, DC.
- Schuler D. 1995. Lake Shaokatan restoration project. *Land Water* May/June:12-15.
- Shannon EE, Brezonik PL. 1972. Limnological characteristics of north and central Florida lakes. *Limnol Oceanogr* 17:97-110.
- Shapiro J, Lamarra V, Lynch M. 1975. Biomanipulation—An ecosystem approach to lake restoration. Proceedings of a Symposium on Water Quality Management Through Control, University of Florida.
- Smart MM, Reid FA, Jones JR. 1981. A comparison of a persulfate digestion and the Kjeldahl procedure for determination of total nitrogen in freshwater samples. *Water Res* 15:919-921.
- Smart MM, Jones JR, Sebaugh JL. 1985. Stream-waterhed relations in the Missouri Ozark Plateau province. *J Environ Qual* 14:79-82.
- Smeltzer E, Heiskary SA. 1990. Analysis and applications of lake user survey data. *Lake Reservoir Manage* 6:109-118.
- Smeltzer E, Walker WW, Garrison V. 1989. Eleven years of lake eutrophication monitoring in Vermont: A critical evaluation. In: *Enhancing State's Lake Management Programs*. U.S. Environmental Protection Agency and North American Lake Management Society, pp. 52-62.
- Smith RA, Schwartz GE, Alexander RB. 1997. Regional interpretation of water quality monitoring data. *Water Res* 33:2781-2798.
- Søballe DM, Bachmann RW. 1984. Removal of Des Moines River phytoplankton by reservoir transit. *Can J Fish Aquat Sci* 41:1803-1813.
- Søballe DM, Threlkeld ST. 1985. Advection, phytoplankton biomass, and nutrient transformation in a rapidly flushed impoundment. *Arch Hydrobiol* 105:187-203.
- Solorzano L, Sharp J. 1980. Determination of total dissolved nitrogen in natural waters. *Limnol Oceanogr* 25:751-754.
- Srinivasan R, Arnold JG. 1994. Integration of a basin-scale water quality model with GIS. *Water Res Bull* 30(3):453-462.
- Straškraba M, Straškrabova V. 1975. Management problems of Slapy Reservoir, Bohemia, Czechoslovakia. In: *Proceedings of a Symposium on the Effects of Storage on Water Quality*, Reading University, Reading, England, pp. 449-484.

Straškraba M, Tundisi JG, Duncan A. 1993. State-of-of-the-art of reservoir limnology and water quality management. In: Straškraba M, Tundisi JG, Duncan A, eds. Comparative reservoir limnology and water quality management. The Netherlands: Kluwer Academic Publishers, pp. 213-288.

Straškraba M, Dostálková I, Hejzlar J, et al. 1995. The effect of reservoirs on phosphorus concentration. *Int Rev Gesamt Hydrobiol* 80:403-413.

Tasker GD, Driver NE. 1988. Nationwide regression models for predicting urban runoff water quality at unmonitored sites. *Water Res Bull* 24(5):1091-1101.

Terstriep ML, Lee MI, Mills EP, et al. 1990. Simulation of urban runoff and pollutant loading from the greater Lake Calumet area. Prepared for the U.S. Environmental Protection Agency, Region 5, Water Division, Watershed Management Unit, Chicago, IL, by the Illinois State Water Survey.

Tetra Tech, Inc. 1995. Hydrodynamic and water quality mathematical modeling study of Norfolk Harbor, Connecticut -Final report. Tetra Tech, Inc., Fairfax, VA.

Thienemann A. 1921. Seeypen. *Naturwissenschaften* 18:1-3.

Thomann RV. 1977. Comparison of lake phytoplankton models and loading plots. *Limnol Oceanogr* 22:370-373.

Thompson SK. 1992. *Sampling*. New York: John Wiley.

Thornton KW. 1990. Sedimentary process. In: Thornton KW, Kimmel BL, Payne FE, eds, *Reservoir limnology: Ecological perspectives*. New York: John Wiley, pp. 43-69.

Thornton KW, Kennedy RH, Carroll JH, et al. 1980. Reservoir sedimentation and water quality—An heuristic model. In: *Proceedings of the Symposium on Surface Water Impoundments*, ASCE, 2-5 June 1980, Minneapolis, MN, pp. 654-664.

Thum RG, Pickett SR, Niemann Jr BJ, et al. 1990. LIS/GIS: Integrating nonpoint pollutant assessment with land development planning. *Wisc Land Inf Newsl* 5(2):1-12.

Tim US, Jolly R. 1994. Evaluating agricultural nonpoint-source pollution using integrated geographic information systems and hydrologic/water quality model. *J Environ Qual* 23:25-35.

Tim US, Mostaghimi S, Shanholtz VO, et al. 1991. Identification of critical nonpoint pollution source area using geographic information systems and simulation modeling. In: *Proceedings of the American Society of Agricultural Engineers (ASAE) International Winter Meeting*, Albuquerque, NM, June 23-26, 1991.

Tshihrintzis VA, Hamid R, Fuentes HR. 1995. Calibration and verification of watershed quality model SWMM in sub-tropical urban areas. In: *Proceedings of the First International Conference-Water Resources Engineering*, American Society of Civil Engineers, San Antonio, TX, August 14-18, 1995, pp. 373-377.

U.S. Army Corps of Engineers. 1998. *National Inventory of Dams*. Office of the Chief, Washington, DC.

- U.S. Environmental Protection Agency. 1974. An approach to a relative trophic index system for classifying lakes and reservoirs. Working Paper No. 24. National Eutrophication Survey, Corvallis, OR.
- U.S. Environmental Protection Agency. 1983. Results of the nationwide urban runoff project. Vol. 1. Office of Water, Washington DC.
- U.S. Environmental Protection Agency. 1992a. Science Advisory Board report to Administrator Browner reviewing "Biological Criteria: Technical Guidance for Streams and Small Rivers." Office of Research and Development, Washington, DC.
- U.S. Environmental Protection Agency. 1992b. TMDL Case Study #4: Nomimi Creek Watershed. TMDL Case Study Series. Office of Water, Washington, DC. EPA 841-F-93-004.
- U.S. Environmental Protection Agency. 1996. Proceedings of the National Nutrient Assessment Workshop, December 4-6, 1995. EPA-822-R-96-004.
- U.S. Environmental Protection Agency. 1997. Compendium of tools for watershed assessment and TMDL development. Office of Water, Washington, DC. EPA 841-b-97-006.
- U.S. Environmental Protection Agency. 1998. National strategy for the development of regional nutrient criteria. EPA-822-R-98-002.
- Verry ES, Timmons DR. 1982. Waterborne nutrient flow through an upland-peatland watershed in Minnesota. *Ecology* 63(5):1456-1467.
- Vieux BE, Needham S. 1993. Nonpoint-pollution model sensitivity to grid-cell size. *J Water Res Plan Manage* 119(2):141-157.
- Vollenweider RA. 1968. The scientific basis of lake and stream eutrophication with particular reference to phosphorus and nitrogen as eutrophication factors. Technical Report DAS/DSI/68.27, Organization for Economic Cooperation and Development, Paris, France.
- Vollenweider RA. 1975. Input-output models with special reference to the phosphorus loading concept in limnology. *Schweiz Zeitschr Hydrol* 37:53-84.
- Vollenweider RA. 1976. Advances in defining critical loading levels for phosphorus in lake eutrophication. *Mem Ist Ital Idrobiol* 33:53-83.
- Vollenweider RA, Kerekes JJ. 1980. Background and summary results of the OECD cooperative program on eutrophication. In: Proceedings of an International Symposium on Inland Waters and Lake Restoration, pp. 26-36. U.S. Environmental Protection Agency. EPA 440/5-81-010.
- Walker WW Jr. 1979. Use of hypolimnetic depletion rate as a trophic status index for lakes. *Water Res* 15:1463-1470.
- Walker, W.W. 1985a. Statistical bases for mean chlorophyll a criteria. pp. 57-62 In *Lake and Reservoir Management: Practical Applications*. Proceedings of the Fourth Annual Conference and International Symposium. October 16-19, 1984. McAfee, NJ, North American Lake Management Society.

- Walker WW Jr. 1985b. Urban nonpoint source impacts on surface water supply. Perspectives on nonpoint source pollution. Proceedings of a national conference, Kansas City, MO, May 19-22, 1985, pp. 129-137. U.S. Environmental Protection Agency. EPA 440/5-85-01.
- Walker WW. 1986. Empirical methods for predicting eutrophication in impoundments; Report 4, Phase 11. Applications Manual. Technical Report E-81-9, U.S. Army Engineer Waterways Experiment Station, Vicksburg, MS.
- Walker WW Jr. 1987. Empirical methods for predicting eutrophication in impoundments. Report 4. Phase III: Application manual, Technical Report e-81-9. USACE WES, Vicksburg, MS.
- Walker WW Jr. 1996. Simplified procedures for eutrophication assessment and prediction: User manual. prepared for USACE, USWES, Vicksburg MS. W-96-2
- Walker JF, Pickard SA, Sonzogni WC. 1989. Spreadsheet watershed modeling for nonpoint-source pollution management in a Wisconsin basin. *Water Res Bull* 25(1):139-147.
- Warwick JJ, Tadepalli P. 1991. Efficacy of SWMM application. *J Water Res Plan Manage* 117(3):352-366.
- Watson SE, McCauley E, Downing JA. 1992. Sigmoid relationships between phosphorus, algal biomass and algal community structure. *Can J Fish Aquat Sci* 49:2605-2610.
- Wedepohl RE, Knauer DR, Wolbert GB, et al. 1990. Monitoring lake and reservoir restoration. U.S. Environmental Protection Agency. EPA 440/4-90-007.
- Welch EB, Cooke GD. 1995. Internal phosphorus loading in shallow lakes: Importance and control. *Lake Reservoir Manage* 11:273-281.
- Wetzel RG. 1966. Variations in productivity of Goose and hypereutrophic Sylvan lakes, Indiana Invest Indiana Lakes Streams 7:147-184.
- Wetzel RG, ed. 1975. *Limnology*. New York: W.B. Saunders.
- Wilson CB. 1990. Lake water quality modeling: An overview of the basics. In: *Enhancing States' Lake/Wetland Programs*. NIPC, NALMS, U.S. Environmental Protection Agency, pp. 133-141.
- Wright HE Jr. 1967. A square-rod piston sampler for lake sediments. *J Sediment Petrol* 37:975-976.
- Wurtsbaugh WA, Vincent WF, Alfaro Tapia R, et al. 1985. Nutrient limitation of algal growth and nitrogen fixation in a tropical alpine lake, Lake Titicaca (Peru/Bolivia). *Freshwater Biol* 15:185-195.
- Young RA, Onstad CA, Bosch DD, et al. 1989. AGNPS: A nonpoint source pollution model for evaluating agriculture watersheds. *J Soil Water Conserv* 44:168-173.



# APPENDIX A

## Nutrient Region Descriptions

### I. Willamette and Central Valleys

- Broad, arable, western valleys that are drier and flatter than the neighboring Western Forested Mountains (II)
- Soils are typically nutrient rich and more naturally fertile than those of the adjacent Western Forested Mountains (II)
- Cropland agriculture is the dominant landuse and contrasts with that of surrounding nutrient regions; associated fertilizer use and irrigation return has affected surficial water quality
- Areas of high human population density occur, unlike in most of the Western Forested Mountains (II)

### II. Western Forested Mountains

- High relief, mostly forested mountains; they contrast with the agriculturally dominated Willamette and Central Valleys (I) as well as the unwooded Xeric West (III) and the Great Plains Grass and Shrublands (IV)
- Elevational vegetation banding occurs. Highest elevations are wet, low-nutrient, glacially modified alpine areas with locally numerous tarns. High areas are dominated by coniferous forests and contain steep-gradient perennial streams. Deciduous trees become more common at lower elevations and grow with conifers in mixed stands that have a grass understory. Lowest areas are more xeric and can be dominated by shrubland and grassland; however, mountain-fed, perennial streams that are lined by riparian vegetation can be common
- Logging is a common landuse and can strongly affect water quality
- Grazing occurs in the Western Forested Mountains (II) especially on shrublands and grasslands; associated nutrient problems occur
- Relatively small areas of agriculture are found in the Puget Lowland (2), near the Pacific Ocean, and within some mountain valleys

### III. Xeric West

- Dry, unforested basins and plateaus with scattered mountains and buttes; the Xeric West (III) is climatically, physiographically, and vegetationally distinct from the Western Forested Mountains (II)
- Xeric West (III) is drier than surrounding nutrient regions
- Perennial streams are rare; those that occur typically originate outside the Region III in the Western Forested Mountains (II)
- Natural vegetation is often desertic and is typically dominated by sagebrush, creosote bush, and grassland; areas of woodland also occur
- Low density grazing is the common landuse of the Xeric West (III); it has affected vegetal cover, surficial water quality, and stream flow characteristics. The landuse mosaic is distinct from that of the Willamette and Central Valleys (I), Western Forested Mountains (II), and South Central Cultivated Great Plains (V)

- Agriculture is found only locally. It is often irrigated, such as in the Imperial, Snake, and Gila valleys, and is characterized by large anthropogenic inputs of nitrogen from artificial fertilizers. Nonirrigated agriculture also occurs, including grain farming in the Palouse
- Locally, areas of high human population density occur along with associated nutrient inputs

#### **IV. Great Plains Grass and Shrublands**

- Semiarid high plains with intermittent or ephemeral streams; perennial streams also occur but usually originate in the Western Forested Mountains (II)
- Great Plains Grass and Shrublands (IV) is drier than the Corn Belt and Northern Great Plains (VI) but moister than the Xeric West (III)
- Natural vegetation is short grass prairie and is distinct from that of the Western Forested Mountains (II), the Xeric West (III), and much of the Corn Belt and Northern Great Plains (VI)
- The Great Plains Grass and Shrublands (IV) is composed mostly of grassland and is largely nonarable; cropland is much less common than in the Corn Belt and Northern Great Plains (VI) and the South Central Cultivated Great Plains (V)
- Grazing is the common landuse and has reduced vegetal cover and affected stream quality
- Cropland occurs locally such as in the Northwestern Glaciated Plains (42) ecoregion

#### **V. South Central Cultivated Great Plains**

- Part of the Great Plains
- The natural vegetation is mostly grassland and is distinct from that of the Western Forested Mountains (II)
- The South Central Cultivated Great Plains (V) is now mostly cropland that is dominated by sorghum and winter wheat farming; the landuse mosaic is distinct from that of the surrounding nutrient regions
- Dense concentrations of animal feed lots are found in the South Central Cultivated Great Plains (V); associated nutrient problems also occur

#### **VI. Corn Belt and Northern Great Plains**

- Rolling glaciated terrain is common; nearly-level, poorly-drained proglacial lakebeds occur locally
- The Corn Belt and Northern Great Plains (VI) is typically covered by nutrient-rich soils that are typically more fertile than those of the Great Plains Grass and Shrublands (IV), Nutrient Poor Largely Glaciated Upper Midwest and Northeast (VIII), and Southeastern Temperate Forested Plains and Hills (IX)
- Soils were derived from glacial drift; alfisols are found in the east while mollisols occur in the west
- The natural vegetation was mostly tall grass prairie and is distinct from that of the Great Plains Grass and Shrublands (IV) and the South Central Cultivated Great Plains (V)
- Today, the Corn Belt and Northern Great Plains (VI) is dominated by cropland agriculture, and extensive corn, soybean, and wheat farming occurs. The landuse mosaic is different from that of surrounding nutrient regions
- Poorly drained areas occur locally and are typically nearly level and clayey; they must be tilled to be arable, and streams are resultantly impacted by severe turbidity problems
- Fertilizers have been extensively applied and nitrates can be found in the ground water
- Locally, feedlots and areas of high human population density occur together with associated nutrient problems.
- Lakes occur locally and are usually eutrophic

## **VII. Mostly Glaciated Dairy Region**

- The Mostly Glaciated Dairy Region (VII) is transitional between the Nutrient Poor Largely Glaciated Upper Midwest and Northeast (VIII) and the Corn Belt and Northern Great Plains (VI)
- Region VII has a mix of nutrient-rich and nutrient-poor soils whereas Region VIII is dominated by relatively thin, nutrient-poor soils and Region VI has nutrient-rich soils
- Region VII contains fewer lakes than Region VIII and more than Region VI
- The lakes of Region VII have varying trophic states while those of Region VIII are typically of better quality
- The length of its growing season is in between that of the cooler Region VIII and the milder Region VI
- The landuse mosaic is dominated by dairying and is generally distinct from that of the Corn Belt and Northern Great Plains (VI); corn farming also occurs like in Region VI but is mostly used for silage
- Dairy cattle are often in close proximity to the region's perennial streams; associated impact on streams and lakes is widespread
- Locally, areas of high human population density and associated nutrient inputs occur

## **VIII. Nutrient-Poor Largely Glaciated Upper Midwest and Northeast**

- The forested Nutrient-Poor Largely Glaciated Upper Midwest and Northeast (VIII) has a high concentration of oligotrophic lakes; lake density and quality is a contrast with those of the Corn Belt and Northern Great Plains (VI) and the Mostly Glaciated Dairy Region (VII)
- Soils are thinner and more nutrient poor than surrounding nutrient regions
- Human population density is low

## **IX. Southeastern Temperate Forested Plains and Hills**

- Irregular plains and hills
- Originally, the Southeastern Temperate Forested Plains and Hills (IX) was mostly forested in contrast to the South Central Cultivated Great Plains (V); areas of savannah and grassland also occurred
- Today, Region IX is a mosaic of forest, cropland, and pasture
- The Southeastern Temperate Forested Plains and Hills (IX) is not as arable as the South Central Cultivated Great Plains (V) or the Corn Belt and Northern Great Plains (VI). However, there is much more cropland than in the Central and Eastern Forest Uplands (XI)
- Lateritic soils are common and are a contrast to the soils of the surrounding nutrient regions
- Areas of depleted soils are found in Region IX and are the result of cotton or tobacco farming
- Major poultry and aquaculture operations are found locally in the Southeastern Temperate Forested Plains and Hills (IX) and associated anthropogenic inputs of nutrients have occurred

## **X. Texas – Louisiana Coastal and Mississippi Alluvial Plains**

- Alluvial and coastal plains
- Alluvial soils are naturally rich in contrast to those of the Southeastern Temperate Forested Plains and Hills (IX); they once supported southern floodplain forest
- Coastal plain soils once supported grassland
- The landuse mosaic of Region X is different from the Great Plains Grass and Shrublands (IV) and the Southeastern Temperate Forested Plains and Hills (IX)
- The dominant landuse of the Texas – Louisiana Coastal and Mississippi Alluvial Plains (X) is cropland agriculture. Cotton, soybeans, rice, sorghum, corn, and wheat are commonly grown

- Fertilizers have been extensively applied and have affected surficial water quality
- Locally, areas of high human population density occur along with associated nutrient inputs

## **XI. Central and Eastern Forest Uplands**

- Mostly forested low mountains and high hills; streams are generally fast moving and are typically clearer than the low gradient streams of the Southeastern Temperate Forested Plains and Hills (IX)
- Scattered areas of intensive agriculture occur, such as in the limestone valleys of the Ridge and Valley (67)
- Major poultry and aquaculture operations are found locally in the Central and Eastern Forest Uplands (XI) along with associated anthropogenic inputs of nutrients

## **XII. Southern Coastal Plain**

- Flat, hot coastal plain that is physiographically distinct from the Southeastern Temperate Forested Plains and Hills (IX)
- Many solution and coastal plain lakes of varying trophic states occur; phosphate deposits locally affect lake quality
- The Southern Coastal Plain (XII) is dominated by extensive areas of citrus orchards and vegetable farming; its landuse mosaic is different from that of the Southeastern Temperate Forested Plains and Hills (IX), the Southern Florida Coastal Plain (XIII), and the Eastern Coastal Plain (XIV)
- Areas of high human population density occur along with associated nutrient inputs

## **XIII. Southern Florida Coastal Plain**

- The Southern Florida Coastal Plain (XIII) is a tropical, nearly level coastal plain with broad wetlands; lakes are much less common than in the Southern Coastal Plain (XII)
- Today, Region XIII is extensively drained for agriculture and sugar cane farming is widespread; its landuse mosaic is distinct from that of the Southern Coastal Plain (XII)
- Locally, areas of high human population density occur along with associated nutrient inputs

## **XIV. Eastern Coastal Plain**

- Coastal plain
- Swampy or marshy areas are found in the southern and central sections and forests grow in the northern portion
- Poorly-drained soils are common in the central and southern portion and nutrient poor soils are found in the northern section
- Cropland is generally limited in extent
- Areas of high human population density occur along with associated nutrient inputs
- Major poultry and aquaculture operations are found locally in the Eastern Coastal Plain (XIV); associated anthropogenic inputs of nutrients have occurred

# APPENDIX B

## STATEWIDE OR REGIONAL APPROACHES

1. **GEORGIA**  
The Georgia Lake Standards Legislation (M. Walker)
2. **MINNESOTA**  
Ecoregional Classification of Minnesota Lakes (S. Heiskary)
3. **NORTH CAROLINA**  
Nutrient Control in North Carolina's Lakes and Reservoirs (D. Reid)
4. **SOUTH DAKOTA**  
A Watershed Approach - South Dakota (W. Stewart)
5. **VIRGINIA**  
The Virginia Nutrient Enriched Waters Designation (J. Gregory)
6. **WISCONSIN**  
Wisconsin Lake Phosphorus Criteria (G. Searle)
7. **TENNESSEE VALLEY**  
The Tennessee Valley Authority Reservoir Vital Signs Monitoring Program:  
Chlorophyll and Nutrients Rating Scheme (N. Carriker and D. Meinert)
8. **BRITISH COLUMBIA**  
The British Columbia Water Use Based Approach (R. Nordin)
9. **ONTARIO**  
Rationale For a Revised Phosphorus Criterion for Precambrian Shield Lakes  
in Ontario (N. Hutchinson)

## LAKE OR RESERVOIR SPECIFIC APPROACHES

10. **DILLON RESERVOIR, COLORADO**  
Dillon Reservoir Phosphorus Standard, Load Allocation, and Crediting  
System (R. Ray)
11. **EVERGLADES, FLORIDA**  
Interim Phosphorus Standards for the Everglades (W. W. Walker)
12. **LAKE CHAMPLAIN, VERMONT, NEW YORK, AND QUEBEC**  
Total Phosphorus Criteria for Lake Champlain (E. Smeltzer)

# 1. Georgia Lake Standards Legislation

*by Max Walker, Georgia Department of Natural Resources*

In 1990, the Georgia General Assembly adopted a lake standards bill (O.C.G.A. 12-5-23.1). A copy of the bill is reproduced below. The legislation requires that the Georgia Environmental Protection Division (EPD) conduct comprehensive studies and develop water quality standards for lakes with a surface area of 1,000 acres or more. The General Assembly provided no funds to support implementation of the legislation. Phase I Diagnostic-Feasibility Studies have been completed by EPD using USEPA Clean Lakes funds on Lakes West Point, Walter F. George, and Jackson. Based on the information collected as a part of the Phase I studies, water quality standards were developed and adopted for each lake. Phase I studies are ongoing on Lakes Lanier, Allatoona, Blackshear, and Carters. At such time as the studies are completed, the EPD will use the information and develop and adopt water quality standards for these lakes.

## **12-5-23.1 Water quality standards for lakes; monitoring; studies and reports; development, approval, and publication of water quality standards.**

- (a) As used in the Code section, the word “lake” means any publicly owned lakes or reservoir located wholly or partially within this state which has a normal pool level surface average of 1,000 or more acres.
- (b) The director shall establish water quality standards for each lake which require the lake to be safe and suitable for fishing and swimming and for use as a public water supply, unless a use attainability analysis conducted within requirements of this article demonstrates such standards unattainable.
- (c) For purposes of this subsection, a multiple parameter approach for lake water quality standards shall be adopted. Numerical criteria including, but not limited to, those listed below shall be adopted for each lake:
  - (A) pH (maximum and minimum);
  - (B) Fecal coliform bacteria;
  - (C) Chlorophyll *a* for designated areas determined as necessary to protect a specific use;
  - (D) Total nitrogen;
  - (E) Total phosphorus loading for the lake in pounds per acre feet per year; and
  - (F) Dissolved oxygen in the epilimnion during periods of thermal stratification.
- (d) The standards for water quality of each lake shall take into account the geographic location of the lake within the state and the location of the lake within its watershed as well as horizontal and vertical variations of hydrological conditions within each lake. The director shall also establish nutrient limits for each of the lakes’ major tributary streams including streams with permitted discharges. Such limits shall be consistent with the requirements of subsection (b) of this Code section and shall be established on the basis of accepted limnological techniques and as necessary in accordance with the legal and technical principles for total maximum daily loads. The nutrient limits for tributary streams shall be established at the same time that the lake water quality standards are established.
- (e) After water quality standards are established for each lake and its tributary streams, the division shall monitor each lake on a regular basis to ensure that the lake reaches and maintains such standards.

- (f) The data from such monitoring shall be public information. The director shall have the authority to close a swimming area if data from samplings indicates, in the opinion of the director, that such action is necessary for public safety.
- (g) Provided funds are available from any source, there shall be a comprehensive study of each lake prior to adopting lake water quality standards for the lake. Study components and procedures will be established after consultation with local officials and affected organizations. The comprehensive study for Lake Sidney Lanier, Lake Water F. George, and West Point Lake shall be initiated during 1990. At least three comprehensive studies for participating lakes shall be initiated in each subsequent year. The duration of each study shall not exceed two years. A scientific report on each comprehensive study shall be published within 180 days after the completion of the study. Draft recommendations for numerical criteria for each of the water quality parameters will be simultaneously published, taking into account the scientific findings. A public notice of the draft recommendations, including a copy of the recommendations, will be made available to the public. Public notice in accordance with Chapter 13 of Title 50, the “Georgia Administrative Procedure Act,” shall be provided for such recommendations. The notice shall be made available at least 30 days prior to board action in a regional public library or county courthouse. The recommendations will be provided to persons submitting a written request. A comment period of not less than 45 days nor more than 60 days will be provided.
- (h) The director or the director’s designate shall conduct a public hearing within the above-referenced comment period in the vicinity of the lake before the final adoption of lake water quality standards for the lake. The director shall announce the date, time, place, and purpose of the public hearing at least 30 days prior to the hearing. A ten-day period subsequent to the hearing will be allowed for additional public comment.
- (i) The Department of Natural Resources will evaluate the comments received during the comment period and during the public hearing and will then develop recommended final standards and criteria for submission to the Board of Natural Resources for consideration and approval.
- (j) The final recommendations of the director for lake water quality standards shall be made to the Board of Natural Resources within 60 days after the close of the comment period subsequent to the public hearing provided for in subsection (h) of this Code section. The standards, with such modifications as the board may determine, shall be considered for adoption by the Board of Natural Resources within 60 days after receiving the recommendations from the director. Such standards shall be published by the department and made available to all interested local government officials and citizens of the area served by the lake.
- (k) At the discretion of the direction, comment periods and deadlines set forth above may be extended, but in no circumstance shall more than one year elapse between the completion of the lake study and the adoption of the final recommendations. (Code 1981, § 12-5-23.1, enacted by Ga. L. 1990, p. 1207, § 1.)

## 2. Ecoregional Classification of Minnesota Lakes

*by Steven Heiskary, Minnesota Pollution Control Agency*

Minnesota has over 12,000 lakes spread across diverse geographic areas. Previous studies had shown distinct regional patterns in lake productivity associated with regional differences in geology, vegetation, hydrology, and land use (Heiskary and Wilson, 1989). Minnesota contains seven ecoregions (Omernik, 1987), and four of the ecoregions contain 98 percent of the lakes. These four ecoregions are the Northern Lakes and Forest (NLF), North Central Hardwood Forest (NCHF), Northern Glaciated Plains (NGP), and Western Corn Belt Plains (WCBP) (Figure 1). Minnesota uses these ecoregions as the framework for analyzing data, developing monitoring strategies, assessing use patterns, and developing phosphorus goals and criteria for lakes (Heiskary, 1989).

**Figure 1: Minnesota Ecoregions**

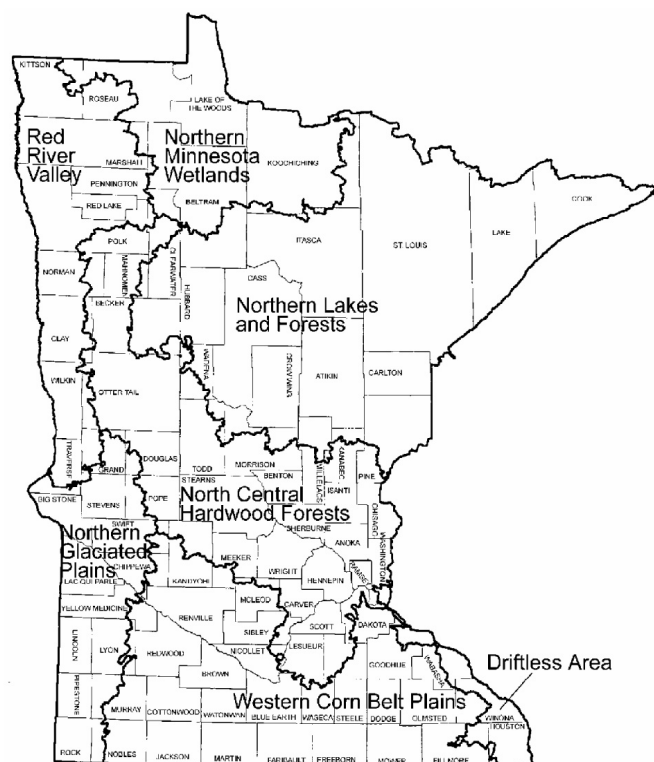



The Minnesota Pollution Control Agency (MPCA) and several other groups collected data on chlorophyll *a* concentrations and several water quality parameters (total phosphorus, total nitrogen, and Secchi transparency) in 90 reference lakes between 1985 and 1987. Secchi transparency data were collected mostly by volunteer participants in the Citizen Lake Monitoring Program. Reference lakes were chosen to represent minimally impacted sites within each ecoregion. Criteria used in selecting reference lakes included maximum depth, surface area, fishery classification, and recommendations from the Minnesota Department of Natural Resources (Heiskary and Wilson, 1989). Lake morphometry had previously been examined. In addition to the reference lake data base, MPCA examined a statewide data base containing data collected by these same groups on approximately 1,400 lakes from 1977 to 1987.

Differences in morphology, chlorophyll *a* concentrations, total phosphorus, total nitrogen, and Secchi transparency were found among lakes in the four ecoregions in both studies. Lakes in the two forested ecoregions (NLF and NCHF) are deeper (median maximum depth of 11 meters), with slightly smaller surface areas (40 to 280 ha), than those in the plains ecoregions (NGP and WCBP). Lakes in the two plains ecoregions were typically shallow (median maximum depth of 3 meters) with larger surface areas (60 to 300 hectares).

Box-and-whisker plots for chlorophyll *a* and water quality measurements in the reference lake study paralleled the morphological differences seen among the ecoregions (Heiskary and Wilson, 1989). The two plains ecoregions had significantly higher chlorophyll *a* levels than either of the two forested ecoregions. Results of the statewide data base analysis showed these same trends. The results of these two data base analyses support the use of ecoregions in developing frameworks for data analysis, monitoring strategies, assessing use patterns, and developing phosphorus goals and criteria for lakes.

# 3. Nutrient Control in North Carolina's Lakes and Reservoirs

*by Dianne Reed, North Carolina Department of Environmental Management*

North Carolina's approach to the control of eutrophication could serve as a model for how to use specific criteria and special programs along with special use classifications to achieve restoration and protection of lakes and reservoirs under the Clean Water Act. This approach provides the flexibility necessary to develop management strategies for the wide variety of responses to nutrient loading seen in North Carolina lakes and reservoirs.

In the late 1970s, in response to extensive algal blooms in a coastal river (Chowan River), which has many characteristics similar to a lake, North Carolina adopted a chlorophyll *a* standard of 40 µg/L for warm waters and 15 µg/L for cold waters as part of its water quality standards. Another important aspect of this standard was the inclusion of a narrative that gives the Director of the Division of Water Quality authority to prohibit or limit any discharge into surface waters if the Director determines that this discharge would contribute to exceedances of the chlorophyll *a* standard. This narrative has allowed the inclusion of more stringent nutrient limits in several permits throughout the state without reclassification or development of basinwide plans.

As a result of the work done on the Chowan River, the Division established an algal bloom program. This program analyzes phytoplankton, chlorophyll *a*, and nutrients, as well as other parameters from lakes, reservoirs, and slow-moving rivers throughout North Carolina. Data collected through this program resulted in a legislative ban on phosphate detergents for the entire state.

Another action that contributed significantly to nutrient control in North Carolina was the development of the Nutrient Sensitive Waters (NSW) supplemental classification. The NSW supplemental classification allows the state to seek abatement of the point and nonpoint source releases of nutrients upstream from a priority water body through the rule-making process. There are a total of six areas that have been declared NSW in North Carolina.

Two of the areas were major reservoir watersheds, Falls of the Neuse Lake and Jordan Lake. Sufficient data were available to adapt nitrogen, phosphorus, and chlorophyll *a* loading/response models and to assess the impact of predicted population growth and changes in wastewater inputs and land use. As a result of the modeling, new wastewater treatment plants, as well as major existing ones, are required to meet a total phosphorus effluent limitation of 2.0 mg/L.

Nonpoint pollution sources also are addressed. The state legislature created a targeted agricultural water quality cost sharing program to provide an incentive for producers and growers to use nutrient abatement practices. The program provides a 75 percent cost share and has been enthusiastically received. To control urban nonpoint sources, the state issued developmental (land use) guidelines to counties and municipalities in the lake watersheds for controlling urban pollutants through local ordinances. With the NPDES stormwater permit program and water supply watershed use designation, North Carolina is well positioned to control eutrophication in its lakes and reservoirs.

Another way that North Carolina is addressing eutrophication of its waters is within the basinwide water quality management process and plans. One example of how these management plans are being successfully used is in Lake Wylie (Catawba River Basin). In 1992, North Carolina documented eutrophic conditions in Lake Wylie and several of its major tributaries. Both point and nonpoint pollution sources were identified as contributing to high nutrient loadings resulting in violations of the State chlorophyll *a* standard. To address eutrophication in Lake Wylie, the State adopted a point and nonpoint

nutrient control strategy for the Lake Wylie watershed. The basis for these actions was the chlorophyll *a* standard and its caveat allowing the Director to require nutrient controls at his or her discretion.

For point sources, the strategy required state-of-the-art nutrient removal for all new or expanding wastewater discharges in the vicinity of the lake. For nonpoint sources, this strategy included targeting of funds from the state's Agricultural Cost Share Program for the Reduction of Nonpoint Source Pollution for implementation of best management practices on agricultural lands in highly impacted watersheds of Lake Wylie.

In conjunction with the 1995 Catawba River basinwide planning effort, the Lake Wylie management strategy was reexamined and updated. As a result of the update, no new discharges will be allowed to the lake mainstem or its tributaries, unless an evaluation of engineering alternatives shows that such a discharge is the most environmentally sound alternative. Any new discharges that meet this requirement will be required to apply advanced removal technology.

New facilities (including expansions) with a permitted design flow of greater than or equal to 1 million gallon per day (MGD) are required to meet monthly average limits of 1 mg/l total phosphorus and 6 mg/l total nitrogen (nitrogen limits to apply for the months April through October only). New facilities and expansions with a permitted design flow of less than 1 MGD but greater than 0.05 MGD are required to meet a total phosphorus limit of 2 mg/l. The industries in the management area are to control TP and TN to best available technology levels as agreed upon with state regulators. It is entirely possible that discharges could receive more stringent nitrogen and phosphorus limits on a case-by-case basis if supported by sampling data and approved by the Director.

To reduce nutrient enrichment in the two most eutrophic arms of Lake Wylie, additional recommendations were made for point source discharges to the Catawba Creek and Crowders Creek watersheds. In both watersheds, incentives are to be established to encourage the privately owned facilities to tie on to larger municipal WWTPs.

# 4. Watershed Approach in South Dakota

by William Stewart, South Dakota Department of Environment and Natural Resources

The State of South Dakota has had ambient water quality standards in place for lakes since the late 1960's. These standards exist in both numeric and narrative forms. Phosphorus is not listed as a parameter in the numeric standards but is covered by the narrative section. At this time, there are no numeric limits on phosphorus on any surface waters of the state.

The Watershed Protection Program is part of the South Dakota Department of Environment and Natural Resources. This program is responsible for nonpoint source pollution control and lake management. The Watershed Protection Program is based on requests for assistance from local groups such as lake associations or conservation districts. Virtually all of the watershed and lake restoration projects in the state are done on a voluntary basis and enforcement is seldom used, except in extreme cases. By far and away, the largest problem for South Dakota lake water quality is sediment and nutrients from agricultural nonpoint source pollution.

The first step in conducting a lake restoration project in South Dakota is the assessment of the lake and its watershed. A typical assessment project is a two-year effort, including intensive water quality monitoring of the lake and tributaries, stream gauging, biological sampling, land-use modeling, and public outreach.

A mathematical relationship developed by Vollenweider and Kerekes (1980) is used to model the relationship between phosphorus inflows and ambient total phosphorus concentrations in the lake. By changing the phosphorus inflows in the equation, corresponding changes in in-lake phosphorus are estimated. In this way, we are able to model changes in chlorophyll *a* concentrations and the response of in-lake phosphorus concentration to the reduction of tributary phosphorus levels.

Once we have determined the target reduction in in-lake phosphorus, we use the Agricultural Nonpoint Source (AGNPS) model to estimate load reductions from the watershed. In order to use the AGNPS program, the watershed is divided into 40-acre cells and 21 parameters are collected for each cell. The model estimates loads of nitrogen, phosphorus, and sediment to the lake. By adding various Best Management Practices to the model, it is possible to determine which practices are needed to reach the estimated watershed phosphorus reduction to produce the desired ambient in-lake phosphorus concentration.

The information from the lake/watershed assessment is used to develop an implementation plan for restoration. The South Dakota Watershed Protection Program has had considerable success with this procedure. The lake and watershed stakeholders generally accept the assessment reports and find them to be useful planning tools in the development of restoration plans.

## References

Vollenwieder, R.A. and J. Kerekes, 1980. *The loading concept as a basis for controlling eutrophication*. Philosophy and preliminary results of the OECD Programme on Eutrophication. Prog. Water Technol. 12:3-38.

# 5. The Virginia Nutrient Enriched Waters Designation

by Jean Gregory, Virginia Department of Environmental Quality

The quality of Virginia's surface waters, particularly those in the Chesapeake Bay drainage area, is affected by the presence of nutrient enrichment. In recognition of this, the State Water Control Board (SWCB), now the Department of Environmental Quality, has developed a strategy to protect the surface waters of the Commonwealth of Virginia from the effects of nutrient enrichment.

In the mid-1980's, the State's General Assembly formed a joint legislative subcommittee to study these problems in the Chesapeake Bay. One of the recommendations in their final report was to direct the SWCB to develop water quality standards by July 1, 1988, to protect Chesapeake Bay and its tributaries from nutrient enrichment. The SWCB decided to expand this standards-setting activity statewide to include other river basins and lakes where there were known nutrient enrichment problems. A second legislative mandate to develop implementation strategies for carrying out these water quality standards was made jointly to the SWCB, which has jurisdiction for point sources, and the Division of Soil and Water, which is responsible for nonpoint source controls. As a result, SWCB developed two regulations that became effective on May 25, 1988. The first established a water quality standard that designated as "nutrient enriched waters" those waters of the Commonwealth that show evidence of degradation due to the presence of excessive nutrients. A companion policy regulation was created to control certain point source nutrient discharges affecting State waters designated as "nutrient enriched waters."

To assist them in developing the water quality standard, the SWCB formed a Technical Advisory Committee (TAC) composed of 19 scientists from east coast universities and the Federal government. There were specific issues the Board was seeking advice on prior to developing these standards, including such issues as whether narrative or numerical standards were needed, appropriate parameters and numerical levels, and the appropriate monitoring, sampling, and evaluation methods.

The SWCB used a variety of policy analysis techniques to obtain recommendations from the committee for the best indicators of nutrient enrichment. First, SWCB mailed a series of three delphi questionnaires to the 19 TAC scientists asking them to identify major issues and thereby reach some consensus on topics to focus on. Responses were anonymous so that the scientists would not bias each other. SWCB followed this process with a two-day spring (May 14-15, 1987) workshop held in Williamsburg by the University of Virginia's Institute of Environmental Negotiation. A summary report was compiled.

The Technical Advisory Committee recommended four parameters that could be used as in-stream indicators of nutrient enrichment. Listed in descending order of importance they are chlorophyll *a*, dissolved oxygen (D.O.) fluctuations, total phosphorus, and total nitrogen. Note that the first two parameters are symptoms of nutrient enrichment rather than direct measurements of nutrients.

Each of these four parameters was considered to develop a recommendation for fresh water lakes.

## *Chlorophyll a*

• Most TAC members favored use of a chlorophyll *a* criterion for lakes. A numerical level of 25 µg/l as a monthly average with a maximum one-time exceedence level of 50 µg/l was proposed. These values received general support from the group. There was a discussion about whether the chlorophyll criterion should be based on planktonic chlorophyll only or whether some consideration should be given to

macrophytic chlorophyll as well. It was determined that a planktonic measure would be easier to sample and would accurately reflect the eutrophic condition of the lake.

It was suggested that monitoring samples be taken at one-half the Secchi depth as long as that depth was greater than 1 foot. An alternative proposal was to use an integrated mixed layer sample which, according to some members, would yield more reliable results. The use of Secchi depth is, however, a well-recognized and reliable method and it was favored for its simplicity.

TAC members thought the numerical chlorophyll criterion for lakes should be combined with a narrative element that would deal with the problems caused by high chlorophyll levels—taste, odor, and clogged filters at water treatment plants.

#### *Dissolved Oxygen*

- It was the consensus of the TAC group that due to wide variation in D.O. at different depths and the difficulty this creates in setting standards and sampling techniques, and the fact that D.O. problems are symptoms that would be reflected in other standards, no lake criterion for D.O. should be recommended. The group did agree that a narrative component addressing the conditions associated with D.O. problems should be drafted.

#### *Total Phosphorus*

- The TAC group suggested two possible lake criteria for total phosphorus in lake waters: a level of 50  $\mu\text{g/l}$  as a weighted mean based on the water mass, or a level of 25  $\mu\text{g/l}$  as a mixed layer mean. These levels were judged to be of equal validity as a measure of total P. (It was noted that if chlorophyll were sampled on a mixed layer basis this might be the preferred approach because the two samples could be taken at the same time.)

#### *Total Nitrogen*

- The TAC group discussed the possibility of linking the criterion for total nitrogen to the criterion for phosphorus. It was suggested that some N to P ratio could be used or that the nitrogen criterion could be set at ten times the phosphorus criterion. After discussion, the group agreed that no nitrogen criterion should be set. Phosphorus is almost always the limiting factor in the eutrophication of Virginia's warm water lakes, and the group thought a nitrogen criterion would be unnecessary.

### ***Recommendations of the TAC***

In freshwater lakes the state should consider setting a chlorophyll *a* criterion of 25  $\mu\text{g/l}$  as a monthly average, with a one-time exceedence level of 50  $\mu\text{g/l}$  with both measured at one-half the Secchi depth (if > 1 foot). This should be combined with a total phosphorus criterion of 50  $\mu\text{g/l}$  as a weighted mean or 25  $\mu\text{g/l}$  as a mixed layer mean. A narrative component should be developed as well to address more general chlorophyll *a* and D.O. problems in lakes.

Taking into consideration the recommendation of the committee, the SWCB decided to base its designations for lakes and all other surface waters on the first three parameters. A reference to these parameters was included in the introduction to the water quality standard regulation for designating nutrient enriched waters. SWCB was intentionally silent on the numerical limits because unacceptable amounts of these parameters could vary depending on the type of water body, whether it were a lake, free-flowing river, or tidal estuary. Because every designation would require an amendment to Virginia's water quality standards, and full public participation is required by the agency and State rules for adopting regulations, SWCB felt that the public would be properly notified in every case of the appropriate scientific and numeric basis for these designations.

Average seasonal concentrations of chlorophyll *a* exceeding 25 mg/l, dissolved oxygen fluctuations, and high water column concentrations of total phosphorus have been the indicators used to date to evaluate the historical data and to identify those waters affected by excessive nutrients. Chlorophyll *a*, a pigment found in all plants, was used as the primary indicator because it indicates the quantity of plant growth.

Based on a review of historical water quality records, the SWCB designated as “nutrient enriched waters” three lakes, one tributary to a lake, nine embayments or tributaries to the Potomac River, the Virginia portion of the Chesapeake Bay, and a large portion of the Bay’s tributaries. Since this initial round of designations, SWCB has amended the standard to designate the tidal freshwater portion of the Chowan River Basin in Virginia. SWCB intends to continue to review these designations and, during each triennial review of water quality standards, will consider additions and deletions to the list. For example, Lake Chesdin is proposed for designation during the current triennial review of the water quality standards regulation.

As SWCB has authority to issue National Pollution Discharge Elimination System (NPDES) permits, and thereby control point source discharges of nutrients, a policy for controlling certain point sources of nutrients to those waters designated as “nutrient enriched” was established. (Another agency, the Division of Soil and Water, developed strategies for managing nonpoint sources of nutrients to “nutrient enriched waters.”) The policy requires certain municipal and industrial organizations that discharge effluents containing phosphorus to maintain a monthly average total phosphorus concentration of 2 mg/L or less. The 2 mg/L limit was based on the following criteria:

- Limits that are readily achievable by chemical addition processes, as demonstrated by experiences in other parts of the country
- Suggested achievable limits for biological phosphorus removal contained in several reports as well as in State pilot plant studies.

SWCB has found that this level of phosphorus removal would result in meeting the 40 percent reduction goal of total phosphorus for point source discharges from Virginia entering into the Chesapeake Bay.

Municipal and industrial dischargers that release phosphorus in concentrations above 2 mg/l to these “nutrient-enriched waters” are subject to this policy if they have a design flow of 1.0 MGD or greater and a permit issued on or before July 1, 1988. These dischargers were required to meet the 2 mg/l effluent limitation as quickly as possible and, in any event, within three years following modification of the NPDES permit. If the discharger voluntarily accepted a permit that required nitrogen removal to meet a monthly average total nitrogen effluent limitation of 10 mg/l for April through October, the discharger was allowed an additional year to meet the phosphorus effluent limitation.

All new source dischargers with a permit issued after July 1, 1988, and a design flow greater than or equal to 0.05 MGD that propose to discharge to “nutrient-enriched waters” are also required to meet a monthly average total phosphorus effluent limitation of 2 mg/l. All dischargers to “nutrient-enriched waters” that, at the time of that designation, were subject to effluent limitations more stringent than the 2 mg/l monthly average total phosphorus are required to continue to meet the more stringent phosphorus limitation.

The policy regulation also contains language that allows SWCB to require monitoring of discharges when the permittee has the potential for discharging monthly average total phosphorus greater than 2 mg/l and also allows adjoining States to petition the Board to consider rulemakings to control nutrients entering tributaries to their nutrient-enriched waters.

The policy regulation states that after the point source controls are implemented and the effects of this policy and the nonpoint source control programs are evaluated, the SWCB recognizes that it may be necessary to impose further limitations on dischargers for additional nutrient control to prevent undesirable growths of aquatic plants. This policy can thus be viewed as the first phase of a strategy to protect Virginia’s waters from the effects of excessive nutrients.

# 6. Wisconsin Lake Phosphorus Criteria

*by Greg Searle, Wisconsin Department of Natural Resources*

In 1991 the Wisconsin Department of Natural Resources (WDNR) began development of water quality criteria for phosphorus for lakes and impoundments. The Phosphorus Technical Workgroup (PTW) was charged with developing scientifically defensible phosphorus water quality criteria and passing the criteria on to a Technical Advisory Committee for implementation consideration. The PTW has completed the development of phosphorus “numbers” (the use of the term “numbers” will be explained after the development section) and has passed those numbers on to a Watershed Advisory Committee.

## ***Development of Phosphorus “Numbers”***

Historical total phosphorus data were obtained from the STORET database for lakes and impoundments across the state. The dataset was censored in the following ways:

- Minimum surface area was equal to or exceeded 25 acres.
- Sample dates were restricted to those collected between June 1 and September 15, inclusive.
- Surface data were utilized and defined as samples that were collected from a depth of four feet or less.

The reduced dataset was further categorized by drainage type and known summer thermal stratification patterns (mixed or stratified). With respect to drainage type, the waterbodies were designated as drainage or seepage waterbodies. The definition of drainage type was associated with the presence or absence of an outlet and not the source of water entering the waterbody.

To account for regional patterns of summer total phosphorus, the STORET data were overlaid on each of 21 sub-ecoregions of Wisconsin proposed by Omernik et al. (1988). Evaluation of these data led to the conclusion that minimal data in many of the sub-ecoregions restricted the ability to accurately derive water quality criteria. Recent efforts of Lillie et. al. (1993) to develop a Trophic State Index (TSI) for Wisconsin lakes showed clear associations between water clarity, chlorophyll *a*, and TP on a regional basis. The PTW agreed that the STORET data should be evaluated using Lillie’s proposed regions.

WDNR staff concluded that a three-way separation (north, central, and south) of phosphorus regions for lakes was supported by the comparison of mean total phosphorus data. When comparing similarly impacted lakes in the proposed North vs. South regions, there was a trend of significance. Mean total phosphorus concentrations in lakes categorized as being moderately or slightly impacted were different, whereas they were not for those lakes categorized as being highly impacted or those that were unranked altogether. This analysis did not support grouping the two regions together. In comparing both the proposed North or the South to the Central region, a consistent difference was not found in mean total phosphorus concentrations. These data clearly indicate that, while the Central region may be grouped with either the North or South Region, it does not bridge the two regions, and therefore supports a different set of water quality standards.

Like the regional inconsistencies observed in the comparative total phosphorus values for lakes, there were also inconsistencies observed in mean total phosphorus values for impoundments. Mean total phosphorus concentrations in the proposed South region were not significantly higher than those for the North. The mean total phosphorus values for the Central region were statistically different when compared with the North and South regions. Since the mean total phosphorus values may be similar in the North and South, but not the North and Central or the South and Central, it was decided to separate the three regions altogether.



Having decided to further evaluate total phosphorus data using the three regions identified by Lillie et al. (1993), the STORET data were combined for each region by drainage type and potential for thermal stratification. Based on PTW consensus, lower quartiles (25 percent quantile) were generated using SAS univariate procedures on all individual total phosphorus values in the censored STORET dataset. Once the lower quartile values were generated, they were further modified by rounding them down to the nearest multiple of five.

Several discussions occurred in previous PTW meetings regarding the significance of using the lower quartile numbers. PTW members exercised their “best professional judgment” and seemed to believe that the lower quartile would provide a conservative estimate of background total phosphorus concentrations in Wisconsin’s lakes and impoundments. The members believed that there were more technical means of determining background values (i.e., paleolimnological studies, lake-specific or impoundment-specific modeling, etc.). They acknowledged, however, that there were resource limitations and agreed that the lower quartiles were the best available method for estimating ambient water quality standards that would lead to satisfactory water quality if met. In accepting the concept of lower quartile-based water quality standards, there was unanimous agreement among PTW members that the group would recommend to the Watershed Advisory Committee that whatever administrative rule revisions were eventually made, there must be language that allows for the development of site-specific criteria where sufficient data are available.

Following the generation of the lower quartile values using each of the individual data points, a “trip” analysis was performed on mean total phosphorus values for lakes and impoundments to determine the relative proportion of waterbodies in a region that would likely exceed the lower quartile estimate. This analysis had been suggested by the PTW membership as a means of stating the degree of impact related to lower quartile-based water quality standards. A similar analysis had been performed in 1991 on a Bureau of Research dataset collected in 1979 in support of a statewide limnological survey of Wisconsin lakes. The key to this dataset was that the data were representative of a random collection of lakes and impoundments. This was in direct contrast to the STORET dataset, which is very reflective of “problem” waterbodies that, in many cases, were studied intensively by the WDNR in an effort to better manage those resources. Due to the random nature of the random lakes data and the fact that they did not necessarily represent “problem” waterbodies, lower quartile and trip analyses were performed on those data in an effort to compare them to the result of the STORET data analyses.

After reviewing the quartile and trip analysis data for both datasets (STORET and random lakes) the PTW agreed that the random lakes data should be used for any subsequent development of draft water quality criteria. The PTW did not want to totally abandon the STORET data, especially when the random lakes data were collected nearly 15 years earlier in 1979. Instead, the PTW membership agreed that a comparison of recently collected STORET data would be compared to the random lakes data to determine if water quality conditions had remained similar. More specifically, it was agreed that STORET data collected in a recent period of consecutive sample years would be analyzed to develop comparative quartiles. The “recent” dataset was to include all data collected in 1989-1993. No data collected in 1988 was to be included because it was a significant drought year. The resulting quartiles would be compared to those already generated for the random lakes dataset, and the PTW would review the comparison at a subsequent meeting. This exercise was begun, but it was found that there was a lack of data from lakes and impoundments that were the same between both datasets. The PTW made a decision not to compare the random dataset and recent STORET data because of this lack of data and also because of the conservativeness of the standards.

The PTW also agreed that impoundments should not be differentiated by drainage type because it is the nature of impoundments to have an outlet. All future standards development for impoundments should only consider the potential for thermal stratification in addition to the regional separation described earlier. The draft lake and impoundment criteria are as listed in Tables 1 and 2.

**Table 1: Ambient Water Quality Criteria for Phosphorus  
in Natural Lakes (µg/L)**

	<b>Drainage/Mixed</b>	<b>Drainage/Stratified</b>	<b>Seepage/Mixed</b>	<b>Seepage/Stratified</b>
North	15	10	10	10
Central	5	5	5	5
South	25	15	15	10

**Table 2: Ambient Water Quality Criteria for Phosphorus in Impoundments (µg/L)**

	<b>Mixed</b>	<b>Stratified</b>
North	15	10
Central	5	5
South	25	15

***Recommendations to the Watershed Advisory Committee***

After thorough review and discussion of the available scientific information on phosphorus and phosphorus-related impacts in lakes and impoundments, the PTW has concluded that meaningful stand-alone categorical statewide phosphorus water quality standards cannot be developed on a state or regional basis. The determination of whether lakes and impoundments have undesirable phosphorus-related impacts should ultimately be made on a site-specific basis, utilizing technical information and partner input. For this reason it is recommended that the numbers developed for use as water quality criteria be used as “triggers” or “flags” to require further action, if exceeded. The numbers were sent forward unlabeled (not criteria) for the Watershed Advisory Committee to determine the proper implementation methods.

The PTW endorses the use of a watershed-based regulatory approach that looks holistically at water quality within the watershed and utilizes partner involvement to prioritize and implement water quality initiatives within the watershed. With respect to phosphorus management, the PTW recommends use of an integrated approach that:

- Uses a screening step to identify those lakes and impoundments that may require a more thorough evaluation for phosphorus-related impacts.
- Establishes a formal evaluation process for these lakes and impoundments that may lead to the development of a site-specific or resource-specific standard, expressed as an in-stream phosphorus concentration, a total maximum daily load (TMDL), or some other appropriate measurement (e.g., chlorophyll *a* density).

## References

- Omernik, J.M. and A.L. Gallant. 1988. See Map Insert in: *Ecoregions of the Upper Midwest States*. United States Environmental Protection Agency: Environmental Research Laboratory - Corvallis, Oregon. EPA/600/3-88/037.
- Lillie, R.A., S. Graham, and P. Rasmussen. 1993. *Trophic State Index Equations and Regional Predictive Equations for Wisconsin Lakes*. Research Management Findings Number 35. Wisconsin Department of Natural Resources. Madison, Wisconsin. 53707.

# 7. The Tennessee Valley Authority Reservoir Vital Signs Monitoring Program: Chlorophyll and Nutrients Rating Scheme

*by Neil Carriker and Dennis Meinert, Tennessee Valley Authority*

## ***Philosophical Approach and Background***

Algae are the base of the aquatic food chain; consequently, measuring algal biomass or primary productivity is important in evaluating ecological health. Without algae converting sunlight energy, carbon dioxide, and nutrients into oxygen and new plant material, a lake or reservoir could not support other aquatic life. Chlorophyll *a* is a simple, long-standing, and well-accepted measurement for estimating algal biomass, algal productivity, and trophic condition of a lake or reservoir (Carlson, 1977).

Developing appropriate expectations is critical to evaluating the implications of chlorophyll concentrations on reservoir ecological health. Generally, lower chlorophyll concentrations in the oligotrophic range are thought of as indicating good water quality conditions. Conversely, high chlorophyll concentrations are usually considered indicative of cultural eutrophication. However, these generalizations must be tempered by geologic and cultural considerations. The range of chlorophyll concentrations considered indicative of good, fair, and poor ecological conditions must be tailored to reflect knowledge of background or natural conditions within each watershed.

It is unrealistic to expect most Tennessee Valley reservoirs to have low chlorophyll concentrations because many are located in watersheds that have nutrient-rich, easily erodible soils. Most lakes and reservoirs in the Tennessee Valley naturally contain sufficient nutrients to support algal populations with chlorophyll concentrations in the mesotrophic range, even in the absence of anthropogenic sources and cultural eutrophication. However, two watersheds in the Tennessee Valley, the Little Tennessee River and the Hiwassee River watersheds, have soils (and consequently waters) with naturally low nutrient levels. The streams in these watersheds drain the Blue Ridge Ecoregion, which is largely characterized by thin soils and is underlain mostly with hard crystalline and metasedimentary rocks.

The classification scheme for evaluating chlorophyll concentrations in Tennessee Valley reservoirs is based on expected “natural” nutrient levels for each watershed. Professional judgment was used to identify concentration ranges indicative of good, fair, and poor conditions. This approach separates Tennessee Valley reservoirs into two classes for chlorophyll expectations—those expected to be naturally oligotrophic because they are in watersheds with naturally low nutrient concentrations and those expected to be naturally mesotrophic. The reservoirs expected to be oligotrophic are in the Blue Ridge Ecoregion. This group includes Hiwassee, Chatuge, Nottely, Blue Ridge, and Parksville reservoirs in the Hiwassee River drainage; and Tellico and Fontana reservoirs in the Little Tennessee River drainage. The remainder, both mainstream Tennessee River reservoirs and reservoirs on tributaries to the Tennessee River, are expected to be mesotrophic.

The concentration ranges identified to represent good, fair, and poor conditions are much lower for reservoirs in the nutrient-poor watersheds. The primary concern for those reservoirs is early identification of cultural eutrophication. With early identification, appropriate actions can be taken to manage nutrient loadings and prevent shifts to higher trophic states. For the reservoirs expected to be mesotrophic, the principal concern is that algal productivity (and chlorophyll levels) not become too great because of the

undesirable characteristics associated with eutrophic lakes (dense algal blooms, poor water clarity, low DOs, and predominance of noxious blue-green algae). For mesotrophic reservoirs where sufficient nutrients are available but chlorophyll concentrations remain low, some other factor such as excessive turbidity or toxicity usually is present that inhibits algal growth. Consequently, the rating for chlorophyll *a* is lowered when those conditions are observed.

### **Data Collection Methods**

Depth-integrated composite chlorophyll *a* samples are collected monthly (April-October) from the photic zone (defined as twice the Secchi depth or 4 meters, whichever is greater). Concurrent algae and zooplankton samples are collected for screening and semi-qualitative examination of the plankton community assemblage. In addition, in-situ water column profiles of temperature, dissolved oxygen, pH, conductivity; and Secchi depth measurements are obtained each time samples are collected. Finally, on three of the monthly surveys (April, June, and August), the photic zone composite samples are analyzed for nutrient levels (total phosphorus, ammonia-nitrogen, nitrate+nitrite-nitrogen, and organic nitrogen) to help in evaluating the chlorophyll data and to help support trophic state assessments.

In 1996, physical/chemical water quality variables were measured at 33 locations on 19 Tennessee Valley reservoirs. Additional details on collection methods are available in an informal TVA report.

### **Chlorophyll Rating Scheme**

Chlorophyll ratings at each sampling location are based on the average summer concentration of monthly, composite photic zone samples collected from April through October (or September). If nutrients are present (e.g., total phosphorus greater than 0.01 mg/L and nitrate+nitrite-nitrogen greater than 0.05 mg/L) but chlorophyll *a* concentrations are generally low (e.g., < 3µg/L), other limiting or inhibiting factors (e.g., high stream flows, turbidity, toxicity, etc.) are considered to be present, and the chlorophyll *a* rating is decreased one unit.

### **References**

Carlson, R.E. 1977. A trophic state index for lakes. *Limnol. Oceanogr.* 22:361-369.

# 8. The British Columbia Water Use Based Approach

by Richard Nordin, British Columbia Ministry of the Environment

British Columbia has elected to establish criteria according to different uses (Nordin, 1986). In three of the water uses they have defined—drinking water, protection of aquatic life, and recreation and aesthetics—nutrients are important. The sequence for determining criteria is shown in Figure 1. Literature review, input from other agencies (e.g., existing criteria), and evaluation of problems that exist or have existed in British Columbia lakes were used to derive the criteria. The literature review focused on interrelationships between nutrients, primary productivity, and hypolimnetic oxygen

Figure 1: Sequence for Determining Water Quality Criteria

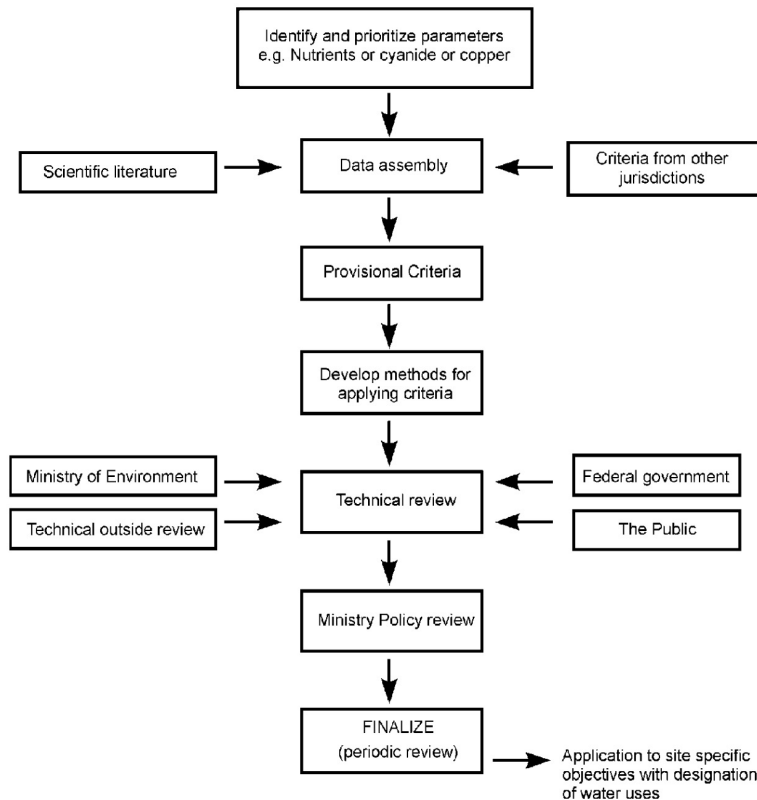

depletion; cold water fishery requirements; and public perception of water quality. British Columbia's criteria are presented in Table 1. Phosphorus concentration was used because there is ample evidence in the literature that quantitative interrelationships exist between it and chlorophyll and transparency, its acceptance as an index of eutrophication, and the advantage of quantifying the controlling parameter.

Nordin (1986) notes that these criteria are proposed specifically for British Columbia, where the lakes fall largely into the oligotrophic category and may not be directly applicable to other areas.

Criteria for lakes supporting warm-water fish were not included (Nordin, 1985). Nordin (1986) notes the difficulty in trying to establish criteria for lakes where a warm-water fishery is the most important use, stating that a phosphorus concentration below 10 µg/L is probably too low (leading to low fish productivity) and that concentrations up to 40 µg/L may be tolerable for lakes where recreational fisheries are important and conditions are suitable. The lack of either empirical or experimental data was cited as a major impediment to suggesting criteria for nutrient concentrations for fish or aquatic life other than the salmonid fishes (salmon and trout) that are of primary concern in British Columbia.

In applying these criteria and checking them against existing water quality, the water exchange time of the lake must be taken into account. The phosphorus concentration is measured at spring overturn (when the epilimnetic water residence time is greater than six months) or the mean epilimnetic growing season concentration is measured (if the epilimnetic residence time is less than six months).

The second step in the process is to apply the criteria to individual lakes. The criteria value may be modified up or down into an “objective” depending on the water uses or other circumstances that may apply for that specific lake. The various factors considered (i.e., data gathered) in establishing the objectives include hydrology, water uses, waste discharges, water quality data (including dissolved oxygen and temperature profiles, general chemistry nutrients, chlorophyll, and transparency),

**Table 1: British Columbia’s Lake Water Quality Criteria for Nutrients**

<b>Most Sensitive Use</b>	<b>Phosphorus Criteria</b>
Drinking water	<10 µg/L
Recreation and aesthetics	<10 µg/L
Aquatic life (cold-water fish)	5-15 µg/L*

\*A range is suggested as the criterion that can be used as the basis for site-specific water quality objectives.

Source: Nordin, 1985.

phosphorus loading, algal species composition, and sediment chemistry. Details on the use of these factors may be found in Nordin (1985). The resulting water quality objectives by themselves have no legal standing and would not be directly enforced (McKean et al., 1987) but are used as a method for planning or for initiating other management techniques or administrative orders.

The objectives are considered policy guidelines for resource managers to protect water uses in the specified water bodies. They guide the evaluation of water quality; the issuing of permits, licenses, and orders; and the management of the fisheries and the province's land base. They will also provide a reference against which the water quality in a particular water body can be checked, and aid decisions on whether to initiate basin-wide water quality studies. In cases where objectives are set, the policy is to put into place a monitoring program for a period of at least three years to evaluate the lake to which the water quality objectives have been applied.

In some cases interim or intermediate goals for lake phosphorus concentrations have been used where ambient concentrations greatly exceeded the proposed criteria.

### ***Uses of Lake Standards in British Columbia***

British Columbia's phosphorus criteria serve as a tool for protecting the most sensitive lake uses. These uses typically include drinking, cold-water fish or other aquatic life, recreation, and aesthetics. The two primary applications of the criteria are:

- To evaluate data on water, sediment, and biota for water quality assessments.
- To establish site-specific water quality objectives.

Water quality objectives serve as policy guidelines for resource managers in their mission to protect water uses in specified water bodies. Water quality objectives guide the resource manager in the evaluation of water quality; issuance of permits, licenses, and orders; and management of fisheries and the watershed (McKean et al., 1987). They also provide a reference against which the water quality status in a particular water body can be monitored, and as a basis for making decisions on the initiation of basin-wide water quality studies. In many instances, the water quality objectives serve as the primary means of planning for the protection and evaluation of water quality (Ministry of Environment, 1985 and 1997).

The Ministry of Environment (1985) promotes the criteria as a means of avoiding the need for costly and high-precision loading studies. In contrast to accuracy needed to establish "critical" loadings in waste allocations, loading estimates in the context of water quality objectives are used only to determine relative contributions from various sources. The loading contribution estimates are then used to prioritize the importance of various inputs. In Okanagan Lake, where the water quality objective for the lake was the same as the 1985 phosphorus concentration (10 µg/L), the management strategy focused on maintaining concentrations (Ministry of Environment, 1985). In this case, if increased "trading" from development and municipal effluent were to occur, then reductions from the sources (e.g., agricultural sources or septic tanks) would need to be sought. This suggests that point/nonpoint source "trading" is among British Columbia's management tools to ensure that water quality objectives are met.

Specific water quality objectives have been set in about 15 lakes where the entire objective setting (rigorous evaluation) has been done. The criteria have been applied to evaluating hundreds of other lakes.

In some of the lakes in the province where long-term eutrophication problems exist and where phosphorus concentrations greatly exceeded the criteria (several lakes with phosphorus concentrations greater than 50 µg/L), the objectives were either set to the criteria (5 to 15 µg/L) or an interim goal (30 µg/L) (Wood Lake in Ministry of Environment, 1985 or Charlie Lake in Nordin and Pommen, 1985).

The most recent approach has been to combine the phosphorus objectives with biological objectives that specify phytoplankton community composition where, for instance, reduction in the frequency or numbers of cyanobacteria is a goal for water quality protection (Cavanagh et al., 1994).



Overall the approach to using a water-use-based approach has been well accepted within British Columbia and is also used by the Canadian federal government in specifying its criteria for a variety of water quality parameters.

## References

- British Columbia Ministry of Environment. 1985. *The phosphorus in the Okanagan Valley Lakes: sources, water quality objectives and control possibilities*. Water Management Branch, Waste Management Branch. Province of British Columbia. British Columbia Ministry of Environment. 1997. *Water Quality in British Columbia - Objectives attainment 1995*. Victoria, BC. 120p.
- Cavanagh, N., R.N. Nordin, and J.E. Bryan. 1994. *Christina Lake Water Quality Assessment and Objectives*. British Columbia Ministry of Environment, Victoria, BC. Summary report 18p. Technical Report 106p.
- McKean, C.J., N.K. Nagpal, and N.A. Zirnhelt. 1987. *Williams Lake water quality assessment and objectives*. Ministry of Environment and Parks, Province of British Columbia.
- Nordin, R.N. 1985. *Water quality criteria for nutrients and algae*. British Columbia Ministry of Environment, Victoria.
- Nordin, R.N. 1986. Nutrient water quality criteria for lakes in British Columbia. *Lake Reserv. Manage.* 2:110-113.
- Nordin, R.N. and L.W. Pommen. 1985. *Peace River area, Charlie lake sub-basin, water quality assessment and objectives (technical appendix)*. BC Ministry of Environment, Victoria, BC. 34p.

# 9. Rationale for a Revised Phosphorus Criterion for Precambrian Shield Lakes in Ontario

*by Neil Hutchinson, Ontario Ministry of Environment and Energy*

The Ontario Ministry of Environment and Energy (OMEE) manages environmental quality primarily through two pieces of provincial legislation, the Environmental Protection Act and the Ontario Water Resources Act. Policies and procedures for management of surface water quality that arise from this legislation are elaborated in implementation documents such as *Water Management: Policies, Guidelines, Provincial Water Quality Objectives of the Ministry of Environment and Energy (1994)* (OMEE, 1994).

The goal of surface water management in Ontario is:

*“to ensure that the surface waters of the province are of a quality which is satisfactory for aquatic life and recreation.”*

Ontario established Provincial Water Quality Objectives (PWQOs) in the 1970s in order to meet this goal. The first objectives were mostly adopted from other agencies, such as the International Joint Commission, but were later developed in Ontario (OMEE, 1992).

“PWQOs are numerical and narrative ambient surface water quality criteria. They are applicable to all waters of the province (e.g., lakes, rivers, and streams) except in those areas influenced by OMEE approved point source discharges. In specific instances where groundwater is discharged to surface waters, PWQOs may also be applied to the groundwater. PWQOs represent a desirable level of water quality that the OMEE strives to maintain in the surface waters of the province. In accordance with the goals and policies in *Water Management (OMEE, 1994)*, PWQOs are set at a level of water quality which is protective of all forms of aquatic life and all aspects of the aquatic life cycle during indefinite exposure to the water. The objectives for protection of recreational water uses are based on public health and aesthetic considerations” (MOEE, 1994).

Two policies are used to interpret the water management goal and application of the PWQOs to specific water bodies (MOEE, 1994).

- *Policy 1*

“In areas which have water quality better than the Provincial Water Quality Objectives, water quality shall be maintained at or above the Objectives. Although some lowering of water quality is permissible in these areas, degradation below the Provincial Water Quality Objectives will not be allowed, ensuring continuing protection of aquatic communities and recreational uses.”

- *Policy 2*

“Water quality which presently does not meet the Provincial Water Quality Objectives shall not be further degraded and all practical measures shall be taken to upgrade the water quality to the Objectives.”

Ontario’s PWQO development process was developed specifically to deal with toxic substances. It uses published studies on the effects of pollutants to estimate a safe concentration for indefinite exposure. The only data that are mandatory for PWQO development are data on toxicity,

bioaccumulation, and mutagenicity (MOEE, 1992), but the process does permit the development of a PWQO based upon aesthetic impairment, such as taste or odor. If insufficient data are not available a “guideline” or “interim objective” status is assigned to the resultant water quality criterion.

### ***Existing PWQO for Total Phosphorus***

The existing PWQO for total phosphorus was developed in the late 1970s (OMEE, 1979). It drew on the trophic status classification scheme of Dillon and Rigler (1975) to protect against aesthetic deterioration and nuisance concentrations of algae in lakes and excessive plant growth in rivers and streams. The rationale (OMEE, 1979) acknowledges that elemental phosphorus can be toxic, but that it is rare in nature and so toxicity is rarely of concern. (In fact, there is only one documented case of elemental phosphorus poisoning an aquatic [marine] system in Canada). Instead, the purpose of the objective was to protect the aquatic ecosystem non-toxic forms of phosphorus :

*“phosphorus must be controlled, however, to prevent any undesirable changes in the aquatic ecosystem due to increased algal growth...” (OMEE, 1979).*

The 1979 PWQO was given the status of a “guideline” both to reflect the uncertainty regarding the effects of phosphorus and to acknowledge the difference between managing toxic and non-toxic pollutants.

*“Current scientific evidence is insufficient to develop a firm objective at this time. Accordingly, the following phosphorus concentrations should be considered as general guidelines which should be supplemented by site-specific studies:*

- *To avoid nuisance concentrations of algae in lakes, average total phosphorus concentrations for the ice-free period should not exceed 20 µg/L.*
- *A high level of protection against aesthetic deterioration will be provided by a total phosphorus concentration for the ice-free period of 10 µg/L or less. This should apply to all lakes naturally below this value.*
- *Excessive plant growth in rivers and streams should be eliminated at a total phosphorus concentration below 30 µg/L.”*

### ***The Need For Revision***

Although the 20 intervening years have shown that the phosphorus guideline is sound, more recent science has revealed new concerns that were not addressed in the original. In 1996, therefore, Ontario decided to review its PWQO for total phosphorus. The bulk of Ontario’s 226,000 lakes (Cox, 1978) lie on the Precambrian Shield, and the scientific basis for a new PWQO had previously been developed for these lakes (Hutchinson et al., 1991). Accordingly, the three-year review process targeted Precambrian Shield lakes first, with off-shield lakes, the Great Lakes, and streams and rivers reviewed later in the process.

The rationale for revisiting the PWQO for phosphorus does not lie exclusively in better information on the effects of phosphorous as a pollutant. Instead, better understanding of watershed processes, biodiversity, and cumulative impact assessment over the past 20 years led to the corporate adoption of these considerations in the water management process (OMEE, 1994). This knowledge revealed several shortcomings with the existing, two-tiered guideline of 10 µg/L for “a high level of protection against aesthetic deterioration” and 20 µg/L “to avoid nuisance concentrations of algae.” Although these numeric objectives are designed to maintain water clarity and aesthetic values and have performed well for over 20 years, they fall short in the area of protecting the diversity of the provincial resource of water quality and any associated biodiversity.

## **Trophic Status Considerations**

The existing numeric objectives for total phosphorus ignore fundamental differences between lake types and their nutrient status in the absence of human impact. Ontario's Precambrian Shield lakes presently span a range of phosphorus concentrations ranging from oligo to mesotrophic, and all are represented in roughly equivalent proportions in the provincial lake resource (Figure 1). Within this range, however, there is still a large diversity of water clarity, controlled by both total phosphorus concentrations and dissolved organic carbon (Dillon et al., 1986).

The logical outcome of a two-tiered objective is that, over time, all recreational waters would converge on one or the other of the water quality objectives. This would produce a cluster of lakes slightly below 10 µg/L and another slightly below 20 µg/L, decreasing the provincial diversity in water quality in lakes and, with it, lower diversity of their associated aquatic communities.

The second shortcoming is that, over time, some lakes would sustain unacceptable changes in water quality while others would be unimpacted, producing both ecological and economic asymmetries as the resource was developed. A lake with a natural phosphorus concentration of 4 µg/L is a fundamentally different lake from one that exists at 9 µg/L. Both lakes, however, would be allowed to increase to 10 µg/L under the existing PWQO. One lake would experience no perceptible change (9 - 10 µg/L) and be overprotected, but the other (4 - 10 µg/L) would be underprotected and change dramatically. In both cases, human perceptions of aesthetics are ignored in the objective. Allocation of phosphorus loadings between these two lakes would be unfair as well. The higher-phosphorus lake could sustain a greater change than the low-phosphorus lake but would be restrained to a much lower load.

A final concern is that the existing PWQO does not explicitly consider the impact of phosphorus on hypolimnetic oxygen or aquatic biota. It does, however, make reference to site-specific studies in the assessment process.

In summary, the existing numeric objectives overprotect some lakes and do not protect others adequately. Allocation of phosphorus loadings is unnecessarily restricted in some lakes and overly generous in others. Neither biotic nor aesthetic attributes are adequately protected. Over time the diversity of trophic status that is presently represented in Ontario will decrease.

### **Environmental Baselines and Measured Water Quality**

An emerging concern in environmental assessment is the need for a standard baseline for comparison against environmental change. Inland lakes respond quickly to point-source phosphorus inputs. Detection of change is much more difficult, however, for non-point sources such as leachate from domestic septic systems.

Existing approvals and interpretation of the existing PWQO are based on measurements of water quality. Measurements of phosphorus made in the period between development of a shoreline and expression of change in trophic status, however, will significantly underestimate its impact and may wrongfully conclude that the lake has not responded to phosphorus loading.

**Figure 1: Existing Distribution of 921 Ontario lakes by Phosphorus Concentration**

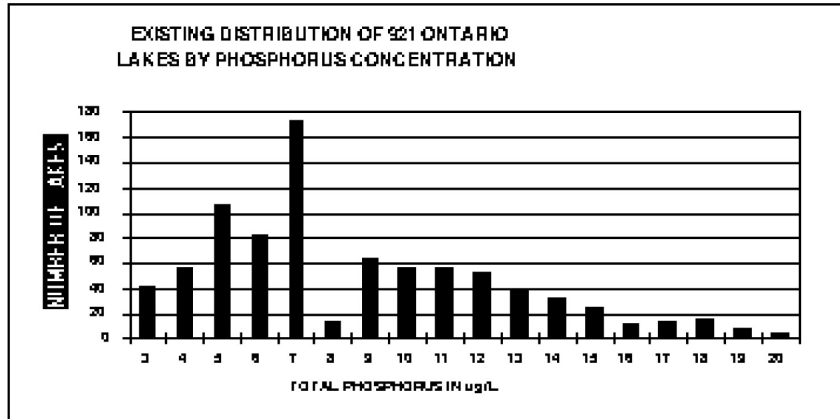

The incremental nature of shoreline development (no lake is ever developed all at once) results in a slow and gradual increase in trophic status. The high degree of seasonal and annual variance in phosphorus levels in lakes (Hutchinson and Clark, 1992) means that changes may not be detectable without an intensive monitoring program, based on many samples and a precise and replicable analytical method.

Finally, a slow increase in trophic status over a generation may not be noticed by human observers. Environmental change that occurs over one generation becomes the status quo for the next. Over a long period, therefore, any assessment baseline that is based on measurements of total phosphorus will increase.

Any phosphorus objective that relies exclusively on measured water quality will therefore suffer from:

- Detection problems due to natural variance and analytical problems
- The lag time between addition of phosphorus to a watershed and its expression in a lake
- Failure to detect incremental changes in water quality
- Human perceptual conditioning that reduces the apparent change in water quality over time

As a result, an increasing assessment baseline and incremental increases in water quality will slowly degrade water quality past any objective. Impacts will accumulate by virtue of delay in their expression, repetition over time and space, extension of the impact boundary by downstream transport, or by triggering indirect changes in the system, such as anoxic sediment release. Non-point source phosphorus pollution, particularly from septic systems serving shoreline development, is thus an excellent example of a pollutant that produces cumulative impacts to the aquatic environment. The emergence and validation of mass balance phosphorus models for lakes, however, offers an opportunity to correct some of the disadvantages of water quality measurements and conventional assessment techniques.

## **Total Phosphorus and the PWQO Development Process**

Development of a PWQO for total phosphorus is distinctly different from that for toxic substances. It is therefore inappropriate to adhere strictly to the established procedures (MOEE, 1992). Because phosphorus is not toxic, insufficient scientific evidence on its toxicity should not be the rationale for its

guideline status. Instead, guideline status should reflect the subjectivity inherent in managing a non-toxic pollutant.

Most pollutants are directly toxic to some target tissue, such as the fish gill, even if some of them are required nutrients at trace amounts, i.e., copper or zinc. As a result, the health of aquatic organisms, and hence the ecosystem, declines rapidly at concentrations slightly above ambient levels (Figure 2). Phosphorus, on the other hand, is a major nutrient. Concentrations can increase substantially with no direct toxic effects. In fact, the first response of the aquatic system is increased productivity and biomass. Beyond a certain point, however, indirect detrimental effects become apparent, which ultimately decrease system health.

Because phosphorus is not toxic, it is used as a surrogate for attributes such as water clarity or dissolved oxygen that we wish to protect. The first responses of a lake to enrichment (i.e., water clarity, algal blooms) are aesthetic and of concern only to humans. Assessment of aesthetic impacts is highly subjective; perceived changes in water clarity are based largely on what one is used to (Smeltzer and Heiskary, 1990). The development of a phosphorus objective must therefore acknowledge an element of subjectivity in dealing with human concerns. The objective-development process may also consider that aesthetic impacts begin where a change in water clarity is first noticeable to the human eye, or where the mean water clarity first exceeds natural variation.

Biotic impacts of phosphorus enrichment, such as the loss of oxygenated hypolimnetic habitat for cold water species (i.e., lake trout [*Salvelinus namaycush*]) are known and can be addressed objectively (Maclean et al., 1990). Dissolved oxygen concentrations are explicitly protected by the Ontario PWQO for Dissolved Oxygen (MOEE, 1994) and are not intended as a direct consideration in phosphorus objective development. Nevertheless, recent advances in oxygen-phosphorus models (i.e., Molot et al., 1992) allow direct estimation of the impact of phosphorus concentrations on dissolved oxygen in lakes. Any protection of dissolved oxygen that is achieved, even indirectly, by the phosphorus objective is beneficial, and its consideration prevents the possibility of one PWQO inadvertently contradicting another.

Finally, trophic status indicators such as water clarity, chlorophyll *a*, or dissolved oxygen cannot be managed directly, but only through management of phosphorus. In addition, there may be delays of up to decades between the addition of phosphorus sources to a watershed (i.e., septic systems), its movement from the source to surface water (Robertson, 1995) and its expression as a change in trophic status. Shoreline residential development represents a significant contribution to eutrophication of Ontario's Precambrian Shield lakes (Dillon et al., 1986). As a result, phosphorus management in Ontario requires the extensive use of models relating shoreline development to the trophic status of the receiving water. Phosphorus management may therefore be considered as a process of "predicting the predictor."

Figure 2: Generalized responses of an ecosystem to toxic and non-toxic pollutants

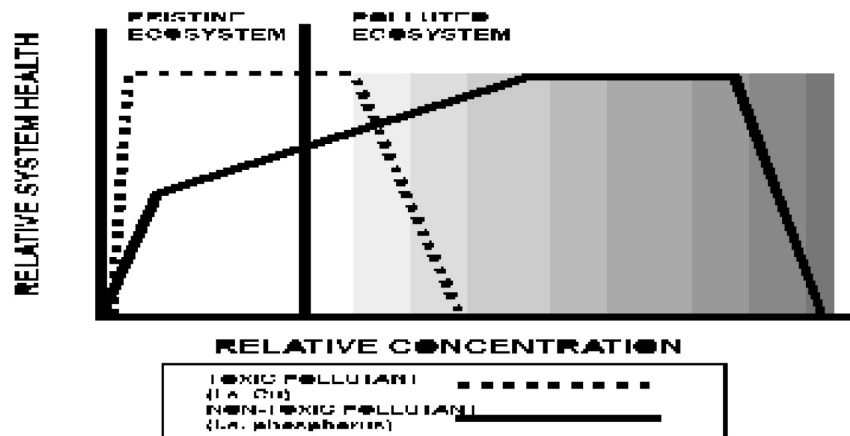

## Proposal for a Revised PWQO

Recent advances in phosphorus modeling, understanding of watershed dynamics, and cumulative impact assessment have been used to propose a new PWQO for Ontario’s Precambrian Shield lakes. The proposal encompasses two innovations: the use of models to establish a baseline for changes in trophic status and a proportional increase from that baseline due to anthropogenic phosphorus loadings. The challenge now lies in expanding this understanding beyond shoreline development in Precambrian Shield lakes, for which it was originally developed, to apply it to all the waters of the province, including off-shield lakes and the Great Lakes, rivers, and streams.

### *Modeled assessment baseline*

The basis of the revised PWQO is increased reliance on water quality modeling in the objective-setting process. Recent advances in trophic status models allow us to calculate the “pre-development” phosphorus concentrations of inland lakes (Hutchinson et al., 1991). This is done by modeling the total phosphorus budget for the lake, comparing the predicted concentration to a reliable water quality measurement, and subtracting that portion of the budget attributable to human activities. Further work is necessary for water bodies lying off of the Precambrian Shield, but the basic premise is applicable to any water body where a phosphorus budget can be calculated.

The main advantage of the modeling approach is establishment of a constant assessment baseline. A modeled “predevelopment” baseline is based on an undeveloped watershed and so will not change over time. This serves as the starting point for all future assessments. Every generation of water quality managers will therefore have the same starting point for their decisions, instead of a steadily increasing baseline of phosphorus measurements.

We therefore propose a PWQO for total phosphorus that is based on a modeled “predevelopment” phosphorus concentration. This will provide water quality managers with:

- A constant assessment baseline,
- A buffer against incremental loss of water quality, and
- A buffer against variable water quality measurements.

The predevelopment phosphorus concentration should not be interpreted as a PWQO. Pristine phosphorus levels have not existed in Ontario for over a century and their attainment is not cost-effective in a heavily developed society. The modeled predevelopment concentration only serves as the starting point for the PWQO and a reference point for future changes.

A model-based objective would have two additional advantages. First, the modeled response of the watershed to future changes is instantaneous. It applies new development directly against capacity, without the intervening decades it takes for phosphorus to move to a lake and be expressed as a measured change in water quality. Second, Ontario’s trophic status model is based on entire watersheds and so allows explicit consideration of downstream phosphorus transport in the assessment.

### ***Proportional Increase***

The second component of the objective is a proportional increase from the modeled predevelopment condition. The proportional increase accommodates regional variation in natural or “background” water quality through the use of one numeric objective for all Precambrian Shield lakes. It is, in fact, a broader, yet simpler, application of the regionally specific, multi-tiered objectives proposed in other jurisdictions as a means of accommodating regional variation in background water quality (i.e., Minnesota—see Heiskary, this volume, and Wisconsin—see Searle, this volume).

Ontario is proposing an allowable increase of 50% above the predevelopment level from anthropogenic phosphorus sources. Under this proposal, a lake that was modeled to a predevelopment phosphorus concentration of 4 µg/L would be allowed to increase to 6 µg/L. Predevelopment concentrations of 6, 10, or 12 µg/L would increase to 9, 15, or 18 µg/L, respectively. A cap at 20 µg/L would still be maintained to protect against nuisance algal blooms.

There are numerous advantages to this approach:

- Each water body would have its own water quality objective, but this could be described with one number (i.e., predevelopment plus 50%).
- Development capacity would be proportional to a lake’s original trophic status.
- As a result, each lake would maintain its original trophic status classification. A 4 µg/L lake would be developed to 6 µg/L and therefore maintain its distinction as oligotrophic. A 9 µg/L lake would be developed to 13.5 µg/L, would maintain its trophic status, and development would not be unnecessarily constrained to 10 µg/L.
- The existing diversity of trophic status in Ontario would be maintained, instead of a set of lakes at 10 µg/L and another at 20 µg/L.

### ***Rationale for 50% Increase***

#### **Water Clarity**

Water clarity in Ontario’s Precambrian Shield lakes is controlled by both dissolved organic carbon (DOC) and phosphorus (Dillon et al., 1986). Any phosphorus objective should therefore consider DOC as well as phosphorus in its derivation. Molot and Dillon (pers. comm.) used 14 years (1976-1990) of data from lakes in south-central Ontario to produce the following relationship, summarized in Figure 3.

$$SD = 6.723 - (0.964 \times DOC) + (9.267/TPep)$$

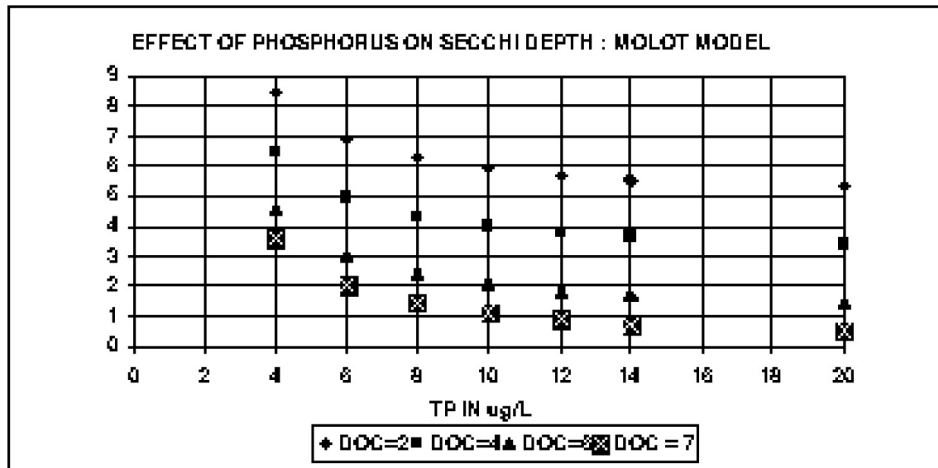

Figure 4 shows the response of water clarity to various proportional increases in total phosphorus concentration, predicted for various DOC levels using the same equation. Responses are grouped to include all lakes with initial phosphorus concentrations between 2 and 14  $\mu\text{g/L}$ , and so a 50% increase represents final values of 3 to 21  $\mu\text{g/L}$ . There is no clear threshold of changed water clarity, a point where further increases in phosphorus would induce a markedly more severe change in water clarity. Instead, Figure 3 shows a gradual loss of water clarity as phosphorus concentrations are increased from 10% to 100%. The allowable percentage increase cannot, therefore, be determined on the basis of water clarity alone.

### Detection of Change in Phosphorus and Water Clarity

The average coefficient of variation in Secchi depth for a series of Southern Ontario Precambrian Shield lakes was 17%-21% over a 14-year period of record (Clark and Hutchinson, 1992). A change of 25% in water clarity would therefore represent a significant departure from natural variation and be detectable against it. A 50% increase in phosphorus concentration produces an average 25% loss of Secchi depth across the range of initial phosphorus (2-14  $\mu\text{g/L}$ ) and DOC (2-7) shown in Figure 3 and Table 1. In addition, a 50% increase protects the clearest and most desirable water clarity and allows a greater proportional change only in those lakes with high DOC where water clarity is limited by DOC instead of by the phosphorus/chlorophyll relationship (Table 1).

**Figure 3: Relationship of Predicted Water Quality to Total Phosphorus and DOC Concentrations in Precambrian Shield Lakes in South-Central Ontario**



**Figure 4: Predicted Response of Secchi Depth in 10-100% Increases in Phosphorus Concentration From Initial Values of 2-14 µg/L**

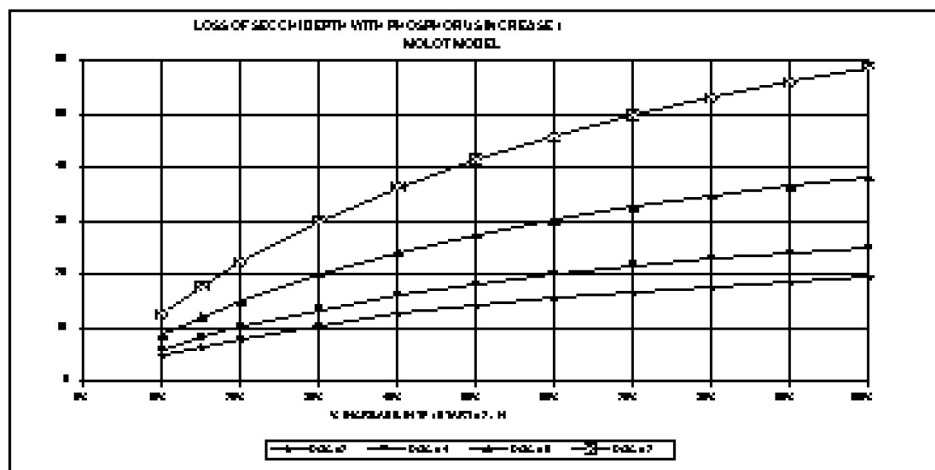

**Table 1: Average loss of Secchi depth with a 50% increase in total phosphorus concentration as a function of dissolved organic carbon concentration**

	DOC=2	DOC=4	DOC=6	DOC=7	Average
% loss of clarity	14	18	27	41	25.3

*Note:* The 50% increase in TP is taken from a starting range of 2-14 µg/L to produce final values of 3-21 µg/L.

Hutchinson et al. (1991) reported a natural coefficient of variation in total phosphorus concentrations in South-Central Ontario lakes of about 20%. Detection of a 20% change in total phosphorus requires only 2 years of spring overturn measurements or 1 year of 4-5 measurements in the ice-free season (Clark and Hutchinson, 1992). A phosphorus objective 50% greater than the predevelopment conditions would therefore be detectable with even the most rudimentary sampling program and would limit changes in water clarity to an average of 25%, a level just beyond the range in natural variation of Secchi depth.

### Protection of Dissolved Oxygen

Dissolved oxygen concentrations are explicitly protected by the Ontario PWQO for Dissolved Oxygen. The existing PWQO for D.O. is 6 mg/L at 10°C for cold-water (stratified) lakes (OMEE, 1994). This marks the upper limit of typical hypolimnetic water temperature, and represents the optimum for the production of lake trout, an esteemed cold-water species in Ontario (Maclean et al., 1990). Although dissolved oxygen concentrations are not intended as a direct consideration in phosphorus objective development, any protection achieved, even indirectly, by the phosphorus objective is beneficial, and its consideration prevents the possibility of one PWQO inadvertently contradicting another. Oxygen-phosphorus models can be used for direct estimation of the impact of phosphorus on dissolved oxygen in lakes.

The Molot et al. (1992) model predicts the hypolimnetic oxygen profile at the critical end-of-summer period, when lakes are warmest and oxygen depletion is near maximum. It was used to model the impact of a 50% increase in phosphorus on dissolved oxygen (Hutchinson, 1997, unpubl.). Four stratified lake

types were modeled, spanning a range from highly sensitive (shallow and small) to least sensitive (deep and large). Responses were expressed as volume-weighted average hypolimnetic oxygen concentration and as the volume of hypolimnion exceeding the PWQO of 6 mg/L.

On average, a 50% increase in phosphorus protects dissolved oxygen in any lake that is larger than 67 ha and 28m or deeper and has less than 12 µg/L of predevelopment phosphorus. Some portion of the hypolimnion remained at 6 mg/L of D.O. or better in all such lakes modeled. Lakes with predevelopment concentrations of 7 µg/L or less were particularly well protected but the 50% increase did not protect lakes that were naturally at 12 µg/L TP or greater, because of their higher initial phosphorus concentrations.

## References

- Clark, B. and N.J. Hutchinson. 1992. Measuring the trophic status of lakes: sampling protocols. Ontario Ministry of the Environment. September, 1992. PIBS 2202. ISBN 0-7778-0387-9. 36pp.
- Cox, E.T. 1978. Counts and measurements of Ontario lakes 1978. Fisheries Branch, Ontario Ministry of Natural Resources. 114pp.
- Dillon, P.J. and F.H. Rigler. 1975. A simple method for predicting the capacity of a lake for development based on lake trophic status. *J. Fish. Res. Bd. Can.* 32: 1519 - 1531.
- Dillon, P.J., K.H. Nicholls, W.A. Scheider, N.D. Yan, and D.S. Jeffries. 1986. Lakeshore Capacity Study: Trophic Status. Final Report. Ontario Ministry of Municipal Affairs. May 1986. ISBN 07743-8077-2. 89pp.
- Heiskary, S.A. and W.W. Walker. 1988. Developing phosphorus criteria for Minnesota lakes. *Lake Reserv. Manage.* 4: 1-10.
- Hutchinson, N.J., Neary, B.P., and P.J. Dillon. 1991. Validation and use of Ontario's trophic status model for establishing lake development guidelines. *Lake Reserv. Manage.* 7: 13-23.
- MacLean, N.G., J.M. Gunn, F.J. Hicks, P.E. Ihssen, M. Malhiot, T.E. Mosindy, and W. Wilson. 1990. Environmental and genetic factors affecting the physiology and ecology of lake trout. *Lake Trout Synthesis - Physiology and Ecology Working Group*. Ontario Ministry of Natural Resources. Toronto. 84pp.
- Molot, L.A., P.J. Dillon, B.J. Clark, and B.P. Neary. 1992. Predicting end-of-summer oxygen profiles in stratified lakes. *Can. J. Fish. Aquat. Sci.* 49: 2363-2372.
- OMEE. 1979. Rationale for the establishment of Ontario's Provincial Water Quality Objectives. Ontario Ministry of the Environment. 236pp.
- OMEE. 1992. Ontario's Water Quality Objective Development Process. Ontario Ministry of the Environment. 42pp + app.
- OMEE. 1994. Water Management: Policies, Guidelines, Provincial Water Quality Objectives of the Ministry of Environment and Energy. Ontario Ministry of Environment and Energy. July 1994. 32pp. PIBS 3303E. ISBN 0-7778-3494-4.
- Robertson, W.D. 1995. Development of steady-state phosphate concentrations in septic system plumes. *J. Contam. Hydrology.* 19: 289-305.
- Smeltzer, E. and S.A. Heiskary. 1990. Analysis and applications of lake user survey data. *Lake and Reserv. Manage.* 6: 109-118.

# 10. Dillon Reservoir Phosphorus Standard, Load Allocation, and Crediting System

*by Robert Ray, Northwest Colorado Council of Governments*

Dillon Reservoir is located in Summit County, Colorado, at an elevation of 9,000 feet. Constructed in 1963 as Denver's primary water supply, the reservoir holds 254,000 acre feet of water and has a surface area of 3,300 acres. Dillon Reservoir has also become a recreational center for fishing, camping, and boating. One of the reservoir's main attractions is its reputation for clear, deep blue water.

During the late 1970's and early 1980's, Summit County was one of the fastest growing areas of the country. About this time, water quality degradation in the reservoir became apparent with the onset of algal blooms. A "Clean Lakes" study identified phosphorus as the limiting factor for algal growth in the reservoir. Studies of phosphorus loading to the reservoir revealed that approximately one-half of the phosphorus load came from natural sources, while the other half was from human activities including municipal wastewater effluent, parking lot runoff, construction site runoff, seepage from septic systems, and other nonpoint sources (Elmore et al., 1985).

A stakeholder committee (the Summit County Phosphorus Policy Committee) was established to develop a strategy for protection of water quality in the reservoir. The Committee included representatives from the towns, the county, the sanitation districts, the Denver Water Department, a ski area, and a mining company. The newly formed Committee established a goal of maintaining the 1982 water quality in Dillon Reservoir. This corresponded to an in-lake phosphorus concentration of 7.4  $\mu\text{g/l}$  during the algal growing season of July through October, adjusted to 1982 hydrologic conditions. Based on this goal, a control regulation was established by the State's Water Quality Control Commission in 1984, which included an in-lake phosphorus standard, a wasteload allocation, and language acknowledging local land use regulations for the control of nonpoint source phosphorus loads.

The four municipal wastewater dischargers to the reservoir installed advanced treatment equipment to control phosphorus, and the wasteload allocation was developed based on build-out projection flows and a phosphorus effluent concentration of 0.2 mg/l (the plants are currently discharging less than 0.05 mg/l phosphorus).

The phosphorus standard served as the numerical basis for back-calculating the necessary load reductions to achieve the desired conditions at zoned "build-out" of the basin. The overall strategy requires a "2 for 1" credit between nonpoint source phosphorus reductions and point source wasteload allocation increases, effective erosion and sediment control practices, mitigation for increases in nonpoint source phosphorus loading from new development, and the use of CDPS (Colorado Discharge Permit System) permits for enforcement if necessary.

There have been three approved applications for phosphorus credits to wasteload allocations to date. It is likely that the main reason that more projects for phosphorus credits have not occurred is the fairly large buffer between the wastewater treatment plants' existing annual loads and their wasteload allocations. The buffer was created by the extremely efficient operations of the wastewater treatment plants.

The reservoir continues to be monitored by the Summit Water Quality Committee (SWQC), which is funded by its participants - the towns, county, and sanitation districts. The SWQC has developed a Phosphorus Accounting System, which was developed to address the concern that the model developed as part of the Clean Lakes study continues to project that at "build out" of the basin, phosphorus loads

will exceed the in-lake standard. The County is using its land use authority to require pound-for-pound mitigation of increased phosphorus loads from increases in zoning density during the Planned Unit Development process.

The reservoir continues to meet its phosphorus standard and chlorophyll *a* goal.

# 11. Interim Phosphorus Standards for the Everglades

by William W. Walker, Jr.

Eutrophication induced by anthropogenic phosphorus loads poses a long-term threat to Everglades ecosystems. Substantial shifts in macrophyte and microbial communities have been observed in regions located downstream of agricultural discharges (Belanger et al., 1989; Nearhoof, 1992; Davis, 1994). This problem developed over a period of three decades following construction of the Central and Southern Florida Flood Control Project and drainage of wetland areas south of Lake Okeechobee to support intensive agriculture (Figure 1).

In 1988, a lawsuit was filed by the federal government against the local regulatory agencies (Florida Department of Environmental Regulation and South Florida Water Management District (SFWMD)) for not enforcing water quality standards in Loxahatchee National Wildlife Refuge (LNWR) and Everglades National Park (ENP). The lawsuit ended in an out-of-court Settlement Agreement (SA) (USA et al., 1991) and federal consent decree in 1992.

Figure 1: Projects in South Florida

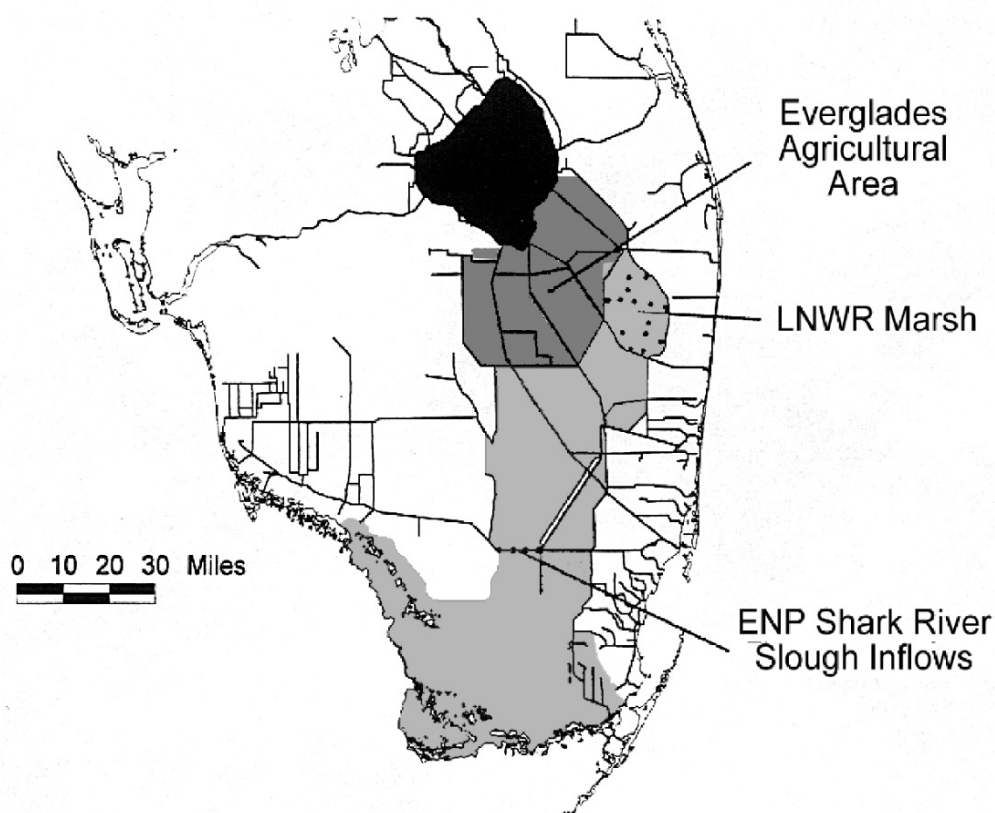

The SA establishes interim and long-term requirements for water quality, control technology, and research. Generally, interim standards and controls are designed based upon existing data and known technologies. The interim control program includes implementation of agricultural Best Management Practices (BMP's) and construction of wetland Stormwater Treatment Areas (STA's) to reduce phosphorus loads from the Everglades Agricultural Area (EAA) by approximately 80 percent, relative to a 1979-1988 baseline.

Subsequently, SFWMD adopted the EAA Regulatory Rule (SFWMD, 1992; Whalen and Whalen, 1994), which requires implementation of BMP's in the EAA to achieve an annual-average phosphorus load reduction of at least 25 percent. The State of Florida (1994) passed the Everglades Forever Act, which defines a construction project and funding mechanism for STA's. Interim phosphorus standards will apply after interim control technologies are in place (1999-2006 for LNWR and 2003-2006 for ENP Shark Slough Inflows). Long-term standards (>2006) and control technologies will be developed over a period of several years and require a substantial research effort to develop supporting data.

Specific statistical procedures for tracking progress of the restoration effort and for determining compliance with interim and long-term objectives are built into the Settlement Agreement, EAA Regulatory Rule, and Everglades Forever Act. These procedures provide measures of performance that are important from technical, political, and legal perspectives. This report describes the general model upon which these procedures are based. Specific applications include:

- P standards for inflows to ENP (2 basins)
- P standards for marsh stations in LNWR
- Load-reduction requirements for the EAA

Each tracking procedure was developed within the constraints of historical data to accomplish a specific objective. They share a model structure which is generally applicable in situations where historical monitoring data are to be used as a frame of reference for interpreting current and/or future monitoring data. This would be the case when the management goal is to restore the system to its historical condition, to prevent degradation beyond its current condition, or to require improvement relative to its historical or current condition. This paper describes the model and its application to ENP Shark River Slough inflows. Other applications are briefly summarized.

## General Model

Explicit consideration of variability is the key to formulating a valid tracking procedure. Procedures are developed by calibrating the following general model to historical data:

$$\text{Response} = \text{Average} + \text{Temporal Effect} + \text{Hydrologic Effect} + \text{Random Effect} \quad (1)$$

The Response is the measurement to be tracked (e.g., concentration or load, averaged over appropriate spatial and temporal scales, linear or log-transformed). The Average represents the mean value of the Response during the calibration period. The Temporal Effect represents a long-term trend in the historical data (if present); this may reflect anthropogenic influences (e.g., land development, new point-source discharges, etc.). The Hydrologic Effect represents correlations of the Response with other measured variables, such as flow, water level, and/or rainfall (if present). The Random Effect is essentially an error term which represents all other sources of variance, including sampling error, analytical error, and variance sources not reflected in the Temporal or Hydrologic terms.

As demonstrated below, inclusion of Temporal and Hydrologic terms increases the statistical power of the tracking procedure (reduces risk of Type I and Type II errors). These terms can be excluded in situations where long-term trends are not present or where significant correlations between the response variable and hydrologic variables cannot be identified. In such a situation, the response would be treated as a purely random variable and the model would be identical to that described by Smeltzer et al. (1989)

for tracking long-term variations in lake water quality. The model can be expanded to include multiple Hydrologic Effects, interactions between Temporal and Hydrologic Effects, as well as other deterministic terms. Seasonal Effects (if present) can be considered by adding another term or eliminated by defining the Response as an annual statistic (average, median, etc.).

The model is not constrained to any particular mathematical form. For example, Hydrologic Effects can be predicted by a simulation model, provided that uncertainty associated with such predictions (Random Effects) can be quantified. The applications described below invoke relatively simple, multiple regression models which provide direct estimates of parameter uncertainty. The Hydrologic term provides a basis for adjusting historical and future monitoring data back to an average hydrologic condition, so that changes in the long-term mean (typically reflecting anthropogenic influences) can be tracked and not confused with random climatologic variability (e.g., wet-year vs dry-year differences).

Table 1 outlines three applications of the model to the Everglades. Data from a consistent, long-term monitoring program are desirable for calibrating and applying the model. Ideal data sets are rarely encountered, however, particularly if historical monitoring programs were not designed explicitly to collect data for this purpose. Everglades applications are based upon data sets ranging from 7 to 11 years in duration with monitoring frequencies ranging from biweekly to monthly. One strength of the data is that sampling and analyses have been consistently performed by a single agency (SFWMD). The following sections describe calibration and application of the model to ENP Shark River Slough inflows.

### **Model Calibration to Historical Monitoring Data**

Interim standards for ENP Shark River Slough were designed to provide annual, flow-weighted-mean concentrations equivalent to those measured between March 1, 1978, and March 1, 1979, the legally established base period consistent with ENP's designation as an Outstanding Florida Water (OFW). Analysis of monitoring data collected between December 1977 and September 1989 collected at five inflow structures (S12A,B,C,D & S333) revealed significant increasing trends in phosphorus concentrations and negative correlations between concentration and flow (Walker, 1991). To reduce possible influences of season and shifts in the flow distribution across the five inflow structures, the annual-average, flow-weighted-mean concentration across all five structures was selected as a response variable and basis for the interim standard. Annual values for Water Years 1978-1990 (October-September) were used to calibrate a regression model of the following form:

$$Y = Y_m + b_1 ( T - T_m ) + b_2 ( Q - Q_m ) + E \quad (2)$$

where

- Y = observed annual, flow-weighted-mean concentration (ppb)
- T = water year (1978-1990)
- Q = basin total flow (1000 acre-ft/yr)
- E = random error term
- m = subscript denoting average value of Y, T, or Q in calibration period

Prior to calibration, biweekly concentration data used to calculate annual flow-weighted means were screened for outliers from a log-normal distribution while accounting for correlations between concentration and flow (Snedocor & Cochran, 1989); a single sample was rejected on this basis. Data from Water Years 1985 and 1986 were excluded from the calibration because of unusual operating conditions which promoted discharge of high-phosphorus canal flows (vs. marsh sheet flows) through the inflow structures. The flow-weighted-mean concentrations were 33 and 21 ppb, respectively, as compared with a range of 7 to 18 in other Water Years. These unusual operating conditions are not expected to be repeated in the future.



**Table 1: Model applications to the Everglades**

Location	Everglades Agricultural Area	ENP Shark Slough Inflows	Loxahatchee National Wildlife Refuge
Reference	EAA Regulatory Rule (1992) Whalen & Whalen (1994)	Interim Standards Settlement Agreement (1991)	Interim Standards Settlement Agreement (1991)
Objective	25% Load Reduction vs. Oct 1979-Sept 1988	1978-79 conditions; baseline period for outstanding Florida waters	1978-79 conditions; baseline period for outstanding Florida waters
Response variable	Total P load	Total P concentration	Total P concentration
Temporal averaging	May-April water year	Flow-weighted mean Sept-Oct water year	Monthly
Spatial averaging	Total EAA thru 18 structures, adjusted for inputs from other basins & releases from Lake Okeechobee	Combined inflows from 5 structures in Shark River slough	Geometric mean across 14 marsh stations
Calibration period	May 1979-April 1988 9 water years 2058 samples	Oct 1977-Sept 1990 11 water years 222 sampling dates 1115 samples	July 1978-July 1983 14 sampling rounds 191 samples
Samples excluded	3 statistical outliers	Oct 1984-Sept 1986 (2 water years, unusual operation) 1 statistical outlier	2 dates with mean stage < 15.42 ft (missing values; marsh sampling difficult)
Temporal effect	None	Linear trend	Step change after base period
Hydrologic effect(s)	Basin rainfall, 9 stations Thiessen average Rainfall statistics: annual total, CV of monthly totals, skewness of monthly totals	Basin total flow Total thru 5 structures	Stage (water surface elev) Average of 3 stations
Transformation	Natural logarithm	None	Natural logarithm
Variance explained	90%	80%	67%
Residual standard error	0.18 (~18%)	1.87 ppb (~16%)	0.31 (~31%)
Base period	Water years 1980-88	Water years 1978-79	June 1978-May 1979 First full year of data
Target	75% of base period (25% load reduction)	100% of base period	100% of base period
Limit	90th percentile	90th percentile	90th percentile
Exceedence condition	> limit in any year, or > target in ≥ 3 consecutive years	> limit in any year	> limit in > 1 month in any consecutive 12-month period

Table 2 lists calibration data and results. The model explains 80% of the variance in the historical data set with a residual standard error of 1.87 ppb. The fit is illustrated in Figure 2. Figure 2A plots observed and predicted concentrations against time. The 80 percent prediction interval (10th, 50th, and 90th percentiles) are shown in relation to the observed data. Both regression slopes are significant at  $p < .05$ . The partial regression concept (Snedocor & Cochran, 1989) is applied below to illustrate the importance of each term in the model.

**Table 2: Derivation of interim standards for ENP Shark River Slough inflows**

Water year	Basin Flow kac-ft/yr	Observed ppb	Predicted ppb	Flow-Weighted-Mean Total P Concentration			
				Flow- Adjusted ppb	Detrended ppb	50% target ppb	90% limit ppb
78	522.8	6.7	8.4	6.7	7.0	8.4	11.7
79	407.0	9.8	9.6	9.2	9.5	9.0	12.3
80	649.2	10.6	9.0	11.2	9.7	9.6	11.1
81	291.7	12.4	11.3	11.4	11.0	10.2	12.9
82	861.3	8.4	9.2	10.0	6.3	10.8	10.1
83	1061.3	7.0	8.9	9.5	4.4	11.4	9.4
84	842.8	12.0	10.5	13.4	8.7	12.0	10.2
87	276.6	15.9	14.9	14.8	10.9	13.8	13.0
88	585.5	15.6	14.1	15.9	10.0	14.4	11.4
89	116.9	13.5	16.9	11.6	7.3	15.0	14.0
90	148.2	18.1	17.3	16.3	11.2	15.6	13.8
Mean	523.9	11.8	11.8	11.8	8.7	8.7	11.8

Variables: Y = observed TP (ppb), T = water year,  $b_1, b_2$  = regression slopes,  $m$  = subscript denoting mean value, Q = observed flow (kac-ft/yr), E = random error (ppb), SE = regression standard error of estimate (ppb),  $m$  = subscript denoting mean value..

$$\begin{aligned} \text{Regression model: } Y &= Y_m = b_1(T - T_m) + b_2(Q - Q_m) + E \\ &= 11.8 + 0.5932(T - 83.7) - 0.00465(Q - 523.9) + E \end{aligned}$$

Regression results:  $R^2 = 0.80$ ,  $SE = 1.873$  ppb,  $Y_m = 11.8$  ppb,  $T_m = 83.7$ ,  $Q_m = 523.9$  kac-ft/yr,  $b_1 = 0.5932$ ,  $\text{Var}(b_1) = 0.02366$ ,  $b_2 = -0.00465$ ,  $\text{Var}(b_2) = -0.00046$ ,  $\text{Cov}(b_1, b_2) = 0.00013$ ,  $t_{\text{dof}} = 1.397$ ,  $n = 11$ .

$$Y_Q = \text{Flow-adjusted TP} = Y + b_2(Q_m - Q) = Y - 0.00465(523.9 - Q)$$

$$Y_T = \text{Detrended TP} = Y + b_1(T_o - T) = Y + 0.5932(78.5 - T)$$

$$\text{Target} = Y_m + b_1(78.5 - T_m) + b_2(Q - Q_m) = 11.16 - 0.00465 Q$$

$$\text{Limit} = \text{Target} + S t_{\text{dof}} = 11.16 - 0.00465 Q + 1.397 S$$

$$\begin{aligned} S &= [\text{SE}^2(1 + 1/n) + \text{Var}(b_1)(T_o - T_m)^2 + \text{Var}(b_2)(Q_c - Q_m)^2 + 2 \text{Cov}(b_1, b_2)(78.5 - T_m)(Q_c - Q_m)]^{0.5} \\ &= [6.377 - 0.00591 Q + 0.00000436 Q^2]^{0.5} \end{aligned}$$

**Figure 2: Model calibration to ENP Shark River Slough inflows**

**Legend:**

Symbols = Observed Flow-Weighted Means  
 Lines = 80% Prediction Intervals  
 A = Observed  
 B = Adjusted to Mean Flow  
 C = Adjusted to 1978-1979 Conditions;  
 October - September Water Years.

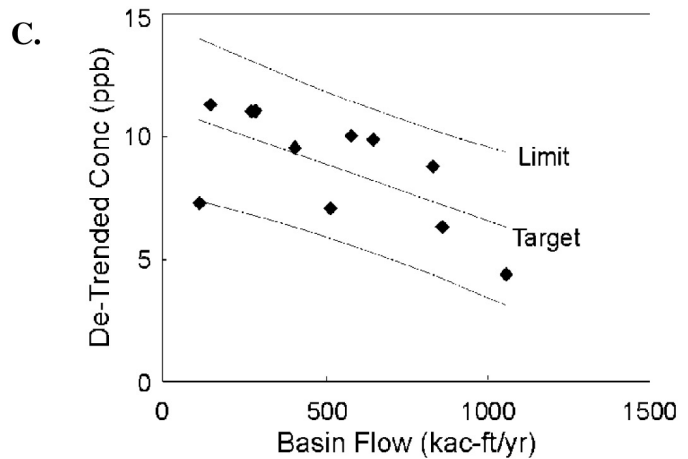
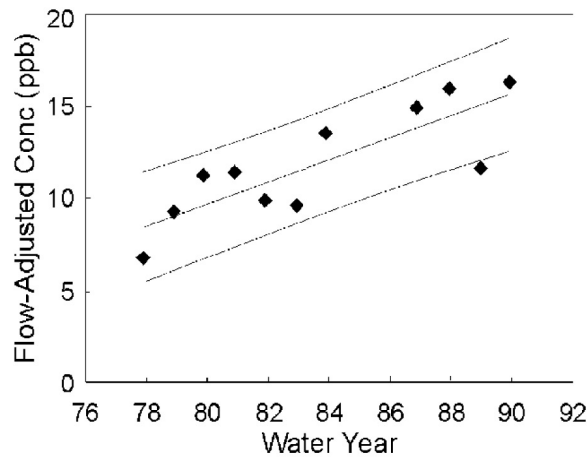
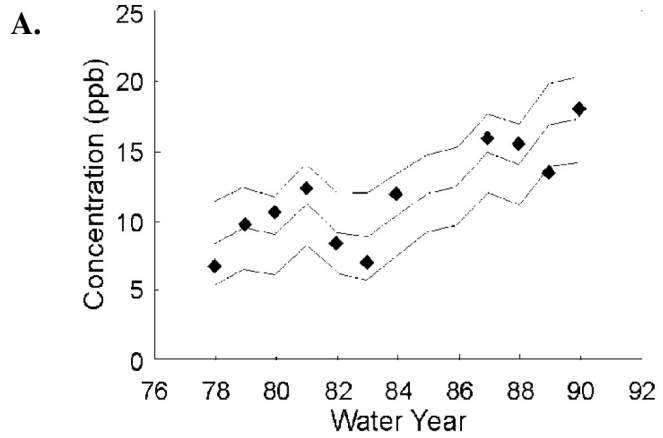

The concentration measured in any year (Y) can be adjusted back to an average flow condition (Qm) using the following equation for flow-adjusted concentration (YQ):

$$YQ = Y + b_2 (Q_m - Q) \quad (3)$$

Figure 2B plots observed and predicted flow-adjusted concentrations against time. The long-term trend is more readily apparent in this display because effects of flow variations have been filtered out.

Similarly, the concentration in any year can be adjusted back to any base period (To) using the following equation for a time-adjusted or de-trended concentration (YT):

$$YT = Y + b_1 (T_o - T) \quad (4)$$

In this case, a base period value of  $T_o = 78.5$  is used to represent the 1978-1979 OFW time frame. Using this equation, Figure 2C plots observed and predicted time-adjusted concentrations against flow. The inverse correlation between concentration and flow is apparent. The figure shows the predicted relationship between concentration and flow if long-term mean were equivalent to that experienced in 1978-1979.

The model can be used to evaluate the likelihood that current monitoring results ( $Y_c$ ,  $Q_c$ ) are equivalent to the 1978-1979 base period, while accounting for hydrologic and random variability. This is accomplished using the following terms which characterize the prediction interval for a 1978-1979 time frame under a given flow condition:

$$\text{Target} = Y_m + b_1 (T_o - T_m) + b_2 (Q_c - Q_m) \quad (5)$$

$$\text{Limit} = \text{Target} + S t_{t, \text{dof}} \quad (6)$$

$$S = [ \text{SE}^2 (1 + 1/n) + \text{Var}(b_1) (T_o - T_m)^2 + \text{Var}(b_2) (Q_c - Q_m)^2 + 2 \text{Cov}(b_1, b_2) (78.5 - T_m)(Q_c - Q_m) ]^{.5} \quad (7)$$

where

Target = 50th Percentile of Prediction Interval = Predicted Mean (ppb)

Limit = 90th Percentile of Prediction Interval (ppb)

S = Standard Error of Predicted Value (ppb)

SE = Regression Standard Error of Estimate (ppb)

t = One-tailed Student's t statistic

Significance Level = 0.10

dof = Degrees of Freedom = n - 3

n = Number of Years in Calibration Data Set = 11

Var = Variance Operator

Cov = Covariance Operator

In Figure 2C, the Target and Limit lines correspond to the 50th and 90th percentile predictions, respectively. The required parameter estimates and variance/covariance terms are derived from a standard multiple regression analysis. If the current long-term flow-weighted-mean is less than the 1978-1979 long-term mean (adjusted for hydrologic effects), there would be less than a 50 percent chance that the yearly mean ( $Y_c$ ) would exceed the Target and less than a 10 percent chance that  $Y_c$  would exceed the Limit. The difference between the Target and Limit reflects the magnitude of the Random Effects term and uncertainty in model parameter estimates ( $b_1$ ,  $b_2$ ,  $Y_m$ ).

### Type I and Type II Errors

Under the terms of the Settlement Agreement, an exceedence of the Limit in any year would trigger further scientific investigations which, in turn, may lead to implementation of additional phosphorus control measures. The significance level for the compliance test (.10) represents the maximum Type-I error rate (probability of exceeding the Limit if the future and 1978-1979 long-term means are exactly equal). Unless a model can be constructed to explain all of the variance in the data, there is no way to design a compliance test without explicitly adopting a maximum Type-I error. In this case, the .10 value was arrived at by negotiation and with the understanding that results of the test would be interpreted by a scientific panel in light of the inherent risk of Type I error.

Type II error (failure to detect an exceedence or excursion from the standard) is another unavoidable feature of compliance tests. In this case, a Type II error would occur when the actual long-term mean exceeds the 1978-1979 flow-adjusted mean but the measured annual mean is still below the Limit. Risk of Type II error depends upon the specified maximum Type I error (10%), model error variance (Random Effects Term), and the magnitude of the excursion from the long-term mean.

Figure 3 illustrates Type I and Type II error concepts. The probability that the annual mean exceeds the Limit is plotted against the difference between the actual long-term mean and the target. Probabilities are calculated using standard statistical procedures (Snedecor and Cochran, 1989; Walker, 1989). Type I errors (false exceedence) may occur when the actual long-term mean is below the target. The risk of Type I error equals the probability shown on the left-hand side in Figure 4 and has maximum value of 10 percent (by design). Type II errors (failure to detect exceedence) may occur when the actual mean exceeds the target. The risk of Type II error equals 100 percent minus the probability shown on the right-hand side of Figure 4 and has a maximum value of 90 percent. As deviation from the target increases, risks of Type I and Type II errors decrease.

Figure 3: Type I and Type II errors

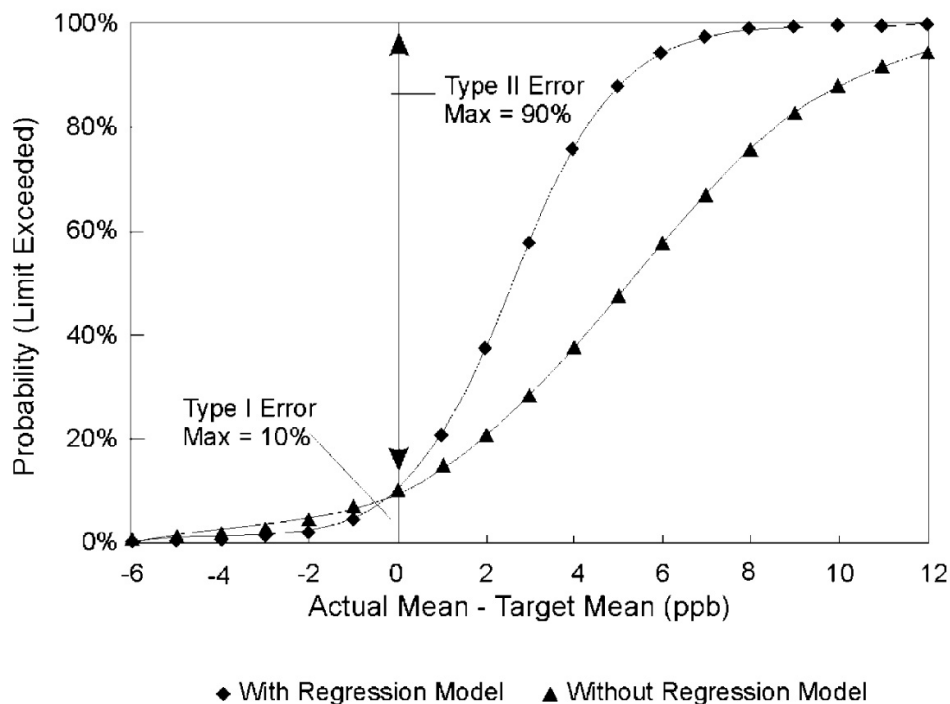

Probability curves are shown for two values of residual standard error in Figure 3. Without applying the regression model, the Random Effects term in the model would have a standard deviation of 3.73 ppb (= standard deviation of annual flow-weighted-means in the calibration period). With the regression model, the standard deviation is reduced to 1.87 ppb. Removing variance associated with trend and flow increases the probability of exceeding the Limit when the long-term mean exceeds the target. For example, if the true long-term mean were 5 ppb above the target, the probability of detecting an excursion (measured annual value above Limit) would be ~90 percent with the regression model, but only ~50 percent without the regression model. Risk of Type I error when the actual mean is below the target is also lower with the regression model. The regression approach thus enables a more powerful compliance test than would result from treating the calibration data set as a random time series.

### **Model Application to Recent Monitoring Data**

Figure 4 shows monitoring results for the Water Years 1991-1996 (6 years following the 1978-1990 calibration period). Although interim standards will not be enforced until 2003, the procedure is useful for tracking responses to control measures implemented over the 1991-2002 period. Such measures include adoption of the EAA Regulatory Rule (requiring a 25% reduction in EAA phosphorus load) in 1992 and operation of the Everglades Nutrient Removal Project (ENR, pilot scale STA removing an additional ~9% percent of the EAA phosphorus load) (Guardo et al., 1995; SFMWD, 1997) starting in August 1994.

Figure 4A shows observed values before and after the calibration period in relation to the 80% prediction interval derived from the above regression model. Values in Figure 4A reflect both long-term trend and flow variations. Observed values in 1992-1996 fall near the lower boundary of the 80% prediction interval (10th percentile).

Figure 4B shows flow-adjusted concentrations (equation 3) in relation to the 80% prediction interval. The prediction interval extrapolates the increasing trend in the 1978-1990 data to the later years. Theoretically, flow-related variations are filtered from this time series, so that observed and predicted values reflect variations in the long-term mean. The plot suggests that the increasing trend present during the calibration period has been arrested in recent years.

Figure 4C plots concentrations against flow in relation to the 80 percent prediction interval for 1978-1979 conditions. Observed values during the 1978-1991 calibration period have been adjusted to the 1978-1979 time frame (equation 4). The middle and upper values in the prediction interval correspond to the Target and Limit values at any flow. Compliance with the interim standards (when they are in effect) will require that the observed (unadjusted) flow-weighted mean fall below the Limit line in every year.

### **Discussion**

Extremely wet conditions experienced in recent years relative to the calibration period impose significant limitations on tracking results. Figure 5 plots annual basin flow against time. Flow exceeded the maximum value experienced in the base period (1061 kac-ft/yr) in 3 out of 6 Water Years after 1990. In these cases, the model is being extrapolated beyond the range of the calibration data set. The extrapolation is particularly large in Water Year 1995, when the average flow exceeded the calibration maximum by approximately 2.5-fold. Because of the extrapolation into high flow regimes, the model does not provide reliable assessments in recent wet years. Nonetheless, the model does provide the best currently available scientific assessment of long-term trends in phosphorus at these structures.

Figure 4B suggests that the increasing trend in the long-term mean present prior to 1991 has been arrested in years following adoption of the EAA Regulatory Rule in 1992 and operation of the ENR in 1994. For the 6-year period between May 1992 and April 1997, the tracking procedure for EAA phosphorus load (Table 1) indicates an average load reduction of 46% relative to the May 1979-April

**Figure 4: Model Application to ENP Shark River Slough Inflows**

**Legend:**

- Diamonds = Observed Flow-Weighted Means, Calibration Period (1978-1990)
- Triangles = Observed Flow-Weighted Means (1991-1996)
- Lines = 80% Prediction Intervals
  - A = Observed
  - B = Adjusted to Mean Flow
  - C = Adjusted to 1978-1979 Conditions (Calibration Period), Observed (1992-1996) Oct. - Sept. Water Years.

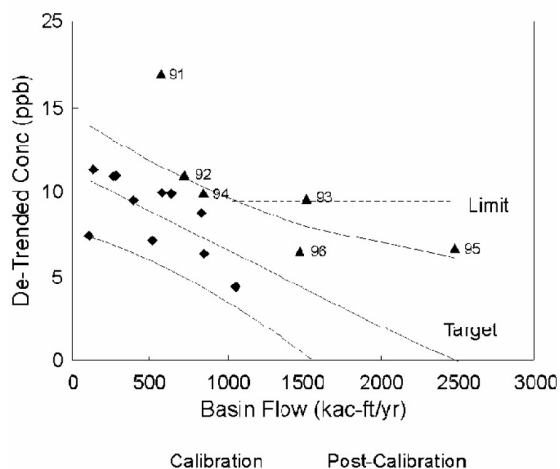
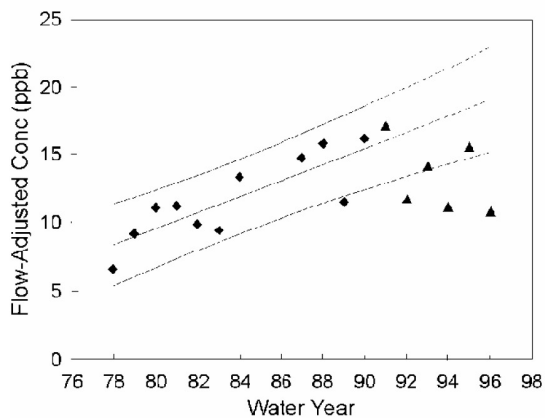
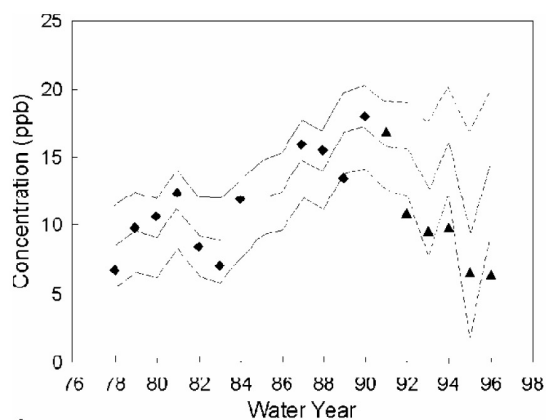

**Figure 5. Flow variations.**

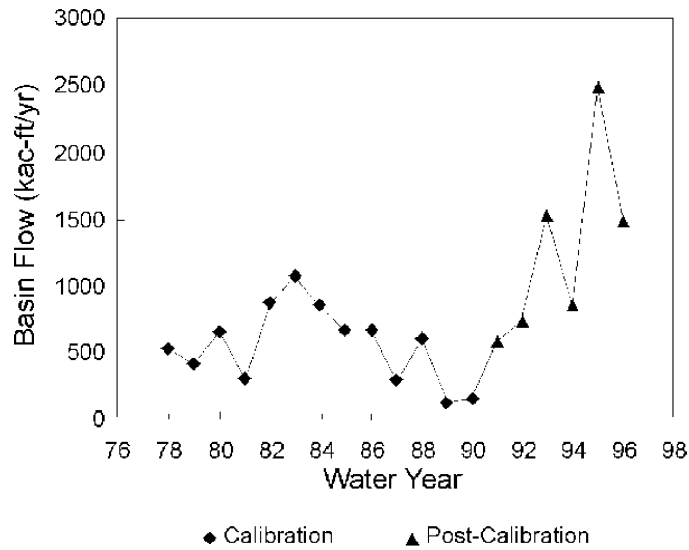

Legend: Diamonds = calibration period (1978-1990); triangles = after calibration period (1991-1996); horizontal line = maximum flow in calibration period Oct-Sept water years.

1988 base period for the Rule and adjusted for variations in rainfall. Figure 6 shows annual variations in phosphorus concentration and adjusted load from the EAA. Compared with the model discussed above, the model for tracking EAA phosphorus loads is calibrated to a slightly different base period and employs a different Water Year definition (May-April). A regression against rainfall statistics (Table 1) is used to adjust measured loads to average hydrologic conditions during the base period. The accuracy of EAA adjusted load estimates is also limited by wet conditions experienced in recent years, however.

EAA runoff concentrations are not adjusted because they are weakly correlated with rainfall. Prediction intervals for concentration are derived by assuming that the Random-Effects term of the model follows a log-normal distribution calibrated to base-period results.

Other possible factors contributing to water quality improvements at ENP inflows during recent wet years include (1) increased phosphorus retention under high-stage conditions in the Water Conservation Areas and (2) shifts in the distribution of flow across the Tamiami Trail. A higher percentage of flow is released through the S12's (western) as opposed to S333 (eastern) in wet years because of flow-control constraints in the Eastern Everglades. Historically, P concentrations at S333 have been higher than those at measured at the S12's, because flows passing through S333 contain a higher percentage of canal flow (vs. marsh sheet flow). Because of limitations in the tracking methodology during recent wet years, several years of monitoring under average and dry conditions will provide a more reliable assessment of ENP inflow water quality conditions in relation to the 1978-1979 OFW period.

Despite signs of improvement, it is unlikely that the interim control objective for ENP Shark Slough inflows has been achieved, since the flow-adjusted means in recent years are consistently above the 1978-1979 flow-adjusted mean (~ 8 ppb, Figures 2B, 4B). Observed concentrations in 1992-1996 cluster



**Figure 6. Variations in EAA runoff P concentratin and adjusted load**

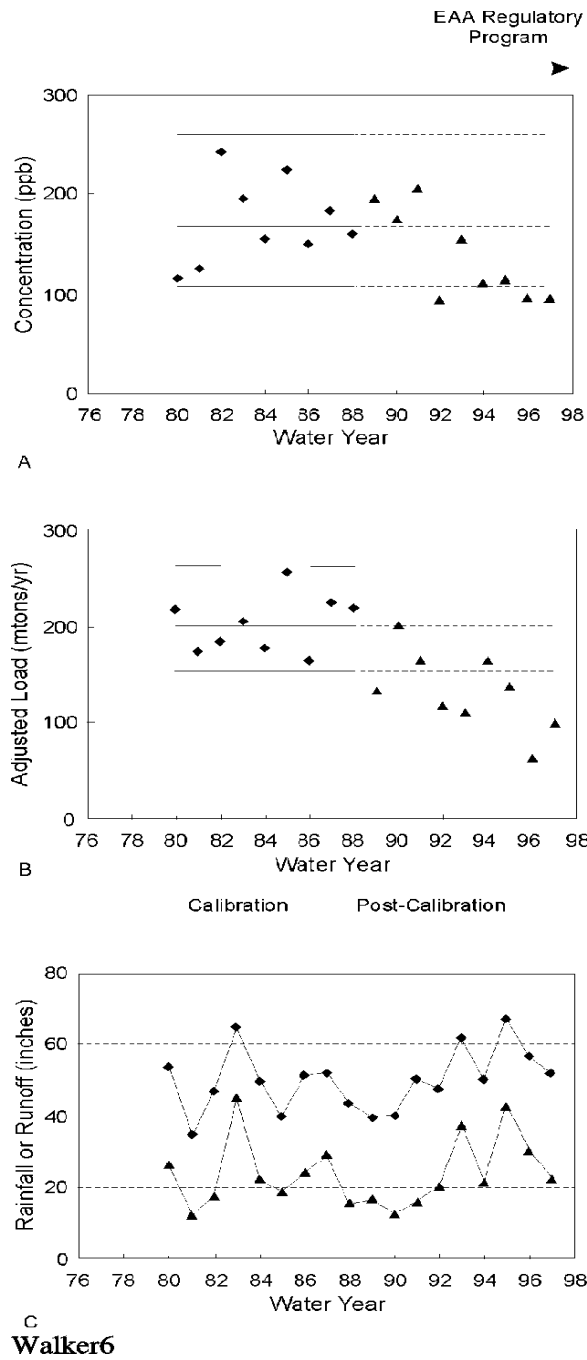

Legend: Diamonds = calibration period (1980-88); triangles = after calibration period (1989-97); lines = 80% prediction intervals; A = flow-weighted-mean total P concentration; B = total P load, adjusted for variations in rainfall; C = average rainfall and runoff.. May-April water years.

around the Limit line in Figure 4C. If the interim objectives were achieved, the observed values would be expected to cluster around the Target line (center of distribution).

Under the provisions of the Settlement Agreement, the maximum flow during the calibration period (1061 kac-ft/yr) will be used to calculate the Limit in years when the observed flow exceeds that value. This essentially prevents extrapolation of the regression beyond the calibration range. The dashed line in Figure 3C shows the Limit calculated according to this procedure. One could argue whether this procedure provides a better estimate of the 90th percentile at high flows than the extrapolated (solid) line. The distribution of observed values after 1991 is such that the determination of “compliance” (if the standard were in effect) would be influenced only in the case of the extreme high-flow year (1995). In the remaining years, the system would have been in compliance in 2 out of 5 years (1994 and 1996), regardless of which limit line is used.

## References

- Belanger, T.V., D.J. Scheidt, J.R. Platko II, “Effects of Nutrient Enrichment on the Florida Everglades”, *Lake and Reservoir Management*, Volume 5, No. 1, pp. 101-111, 1989.
- Davis, S.M., “Phosphorus Inputs and Vegetation Sensitivity in the Everglades”, in *Everglades - The Ecosystem and Its Restoration*, S.M. Davis and J.C. Ogden (Editors), St. Lucie Press, Florida, pp. 357-378, 1994.
- Guardo, M., L. Fink, T.D. Fontaine, S. Newman, M. Chimney, R. Bearzotti, G. Goforth, “Large-Scale Constructed Wetlands for Nutrient Removal from Stormwater Runoff: An Everglades Restoration Project”, *Environmental Management*, Volume 19, No. 6, pp. 879-889, 1995.
- Nearhoof, F.L., “Nutrient-Induced Impacts and Water Quality Violations in the Florida Everglades”, Florida Department of Environmental Protection, Water Quality Technical Series, Volume 3, Number 4. 1992.
- Smeltzer, E., W.W. Walker, and V. Garrison, “Eleven Years of Lake Eutrophication Monitoring in Vermont: A Critical Evaluation”, in “Enhancing States’ Lake Management Programs”, U.S. Environmental Protection Agency and North American Lake Management Society, pp. 52-62, 1989.
- Snedecor, G.W., and W.G. Cochran. “Statistical Methods”, Iowa State University Press, Ames, Iowa, Eighth Edition, 1989.
- South Florida Water Management District, “Surface Water Improvement and Management Plan for The Everglades, Appendix E, Derivation of Phosphorus Limits for Everglades National Park and Phosphorus Levels for Loxahatchee National Wildlife Refuge,” West Palm Beach, Florida, March 13, 1992.
- South Florida Water Management District, “Works of the District, Chapter 40-E63, Everglades Agricultural Area Regulatory Program,” West Palm Beach, Florida, 1992.
- South Florida Water Management District, “Everglades Nutrient Removal Project, 1996 Monitoring Report”, submitted to Florida Department of Environmental Protection, March 1997.
- State of Florida, “Everglades Forever Act”, 1994.
- United States of America, South Florida Water Management District, Florida Department of Environmental Regulation, “Settlement Agreement”, Case No. 88-1886-CIV-HOEVELER, July 1991.
- Walker, W.W., “LRSD.WK1 - Lake/Reservoir Sampling Design Worksheet,” Software Package Number 3, North American Lake Management Society, 1989.
- Walker, W.W., “Derivation of Phosphorus Limits for Inflows to Everglades National Park”, prepared for U.S. Department of Justice, Environment and Natural Resources Division, May 1991.
- Walker, W.W., “Derivation of Phosphorus Limits for Loxahatchee National Wildlife Refuge”, prepared for U.S. Department of Justice, Environment and Natural Resources Division, May 1991.
- Walker, W.W., “Water Quality Trends at Inflows to Everglades National Park”, *Water Resources Bulletin*, Volume 27, No. 1, pp. 59-72, 1991.
- Whalen, B.M., and P.J. Whalen, “Nonpoint Source Regulatory Program for the Everglades Agricultural Area”, American Society of Agricultural Engineers, Paper Number FL94-101, 1994.

# 12. Total Phosphorus Criteria for Lake Champlain

*by Eric Smeltzer, Vermont Department of Environmental Conservation*

Lake Champlain is a 170 km long natural lake shared by the States of Vermont and New York and the Province of Quebec, with a basin population of over 600,000. The major use of the lake is for recreation, although the lake also serves as a water supply for 180,000 people. There are 88 point source phosphorus discharges in the Lake Champlain Basin, although nonpoint sources represent over 70% of the total phosphorus loading to the lake (Smeltzer and Quinn, 1996). Total phosphorus concentrations vary spatially within Lake Champlain over a range of 9-58 µg/L.

Total phosphorus concentration criteria have been established for 13 segments of Lake Champlain in the Vermont Water Quality Standards and in a New York, Quebec, and Vermont Water Quality Agreement for Lake Champlain. The phosphorus criteria were derived in part from an analysis of lake user survey data. The user survey analysis established quantitative relationships between total phosphorus concentrations and the frequency of aesthetic problems and recreational use impairments caused by algae. The criteria were used to guide a process involving phosphorus load measurements and mass balance modeling that resulted in a phosphorus reduction agreement and basin plan completed in accordance with the federal Lake Champlain Special Designation Act of 1990. Allowable phosphorus loads were established for each sub-watershed in Vermont, New York, and Quebec in order to attain the in-lake phosphorus criteria.

## User Survey Analysis and Derivation of the Criteria

Lake user surveys have been used in Vermont, Minnesota, and elsewhere to identify specific total phosphorus, chlorophyll a, or Secchi disk values at which algal nuisances and impairment of recreation are perceived by the public (Heiskary and Walker, 1988; Smeltzer and Heiskary, 1990; North American Lake Management Society, 1992). The user survey form used in Lake Champlain from 1987-1991 as part of a citizen volunteer water quality monitoring program is shown in Table 1. The first survey question (A) asked the observers to describe the physical condition of the lake water at the time samples were taken. The second question (B) sought an opinion on the recreational suitability of the lake at the time of sampling. The survey responses were accompanied by simultaneous water quality measurements using standard sampling and analytical procedures employed by the Vermont Lay Monitoring Program (Picotte, 1997).

The results from the five years of user survey data in Lake Champlain included over 900 individual observations distributed among 28 lake stations in which citizen monitors completed the survey form at the same time measurements were made of total phosphorus, chlorophyll-a, and Secchi disk depth. The results are illustrated in Figure 1.

Figure 1 shows the transitions that occur in lake user perceptions and enjoyment as the degree of eutrophication increases in Lake Champlain. Where total phosphorus and chlorophyll-a concentrations are low, and transparency high, few observers indicate that they see high algae levels or find their enjoyment of the lake substantially reduced by algae in the water. However, as phosphorus and

**Table 1. User Survey Form Used in Lake Champlain from 1987 to 1991**

- A. Please circle the one number that best describes the physical conditions of the lake water today.**
1. Crystal clear water.
  2. Not quite crystal clear, a little algae.
  3. Definite algal greenness, yellowness, or brownness apparent.
  4. High algal levels with limited clarity and/or mild odor apparent.
  5. Severely high algae levels with one or more of the following: massive floating scums on lake or washed up on shore, strong foul odor, or fish kill.
- B. Please circle the one number that best describes your opinion on how suitable the lake water is for recreation and aesthetic enjoyment today.**
1. Beautiful, could not be any nicer.
  2. Very minor aesthetic problems; excellent for swimming, boating, enjoyment.
  3. Swimming and aesthetic enjoyment slightly impaired because of algae levels.
  4. Desire to swim and level of enjoyment of the lake substantially reduced because of algae levels.
  5. Swimming and aesthetic enjoyment of the lake nearly impossible because of algae levels.

chlorophyll levels increase and transparency declines, indications of obvious algal greenness in the water, and impairment of lake use, become more frequent responses.

The results shown in Figure 1 were used to quantify the instantaneous phosphorus levels at which critical transitions in user perceptions occur in Lake Champlain. User descriptions such as "a little algae" and "very minor problems" predominate when total phosphorus concentrations are below about 25 µg/L. Above the 25 to 30 µg/L phosphorus interval, responses such as "definite algal greenness" and "use slightly impaired" are most commonly noted. More severe nuisance perceptions involving "high algae levels" and "enjoyment substantially reduced" also begin to become frequent as phosphorus levels increase above 25 µg/L. These results suggested that an instantaneous total phosphorus concentration of 25 µg/L could be used to derive eutrophication criteria values for Lake Champlain.

Lake eutrophication criteria are best expressed as season or annual mean values, rather than as instantaneous "not to exceed" values. Means are estimated with greater statistical stability by monitoring programs and are more readily predicted by lake models (Walker, 1985; North American Lake Management Society, 1992). An analysis of within-season temporal frequency distributions for total phosphorus in Lake Champlain was used to define a summer mean value corresponding to an appropriately low frequency of occurrence of the 25 µg/L instantaneous nuisance criterion, using Walker's (1985) statistical algorithm. Simple nonparametric tabulation approaches have also been used for this purpose (Heiskary and Walker, 1988).

The relationship between the summer station-mean total phosphorus concentration and the frequency of values greater than 25 µg/L recorded at Lake Champlain monitoring stations is shown in Figure 2. Figure 2 was used to derive a mean phosphorus criterion of 14 µg/L, representing a value at which the 25 µg/L nuisance value would be exceeded only 1% of the time during the summer.

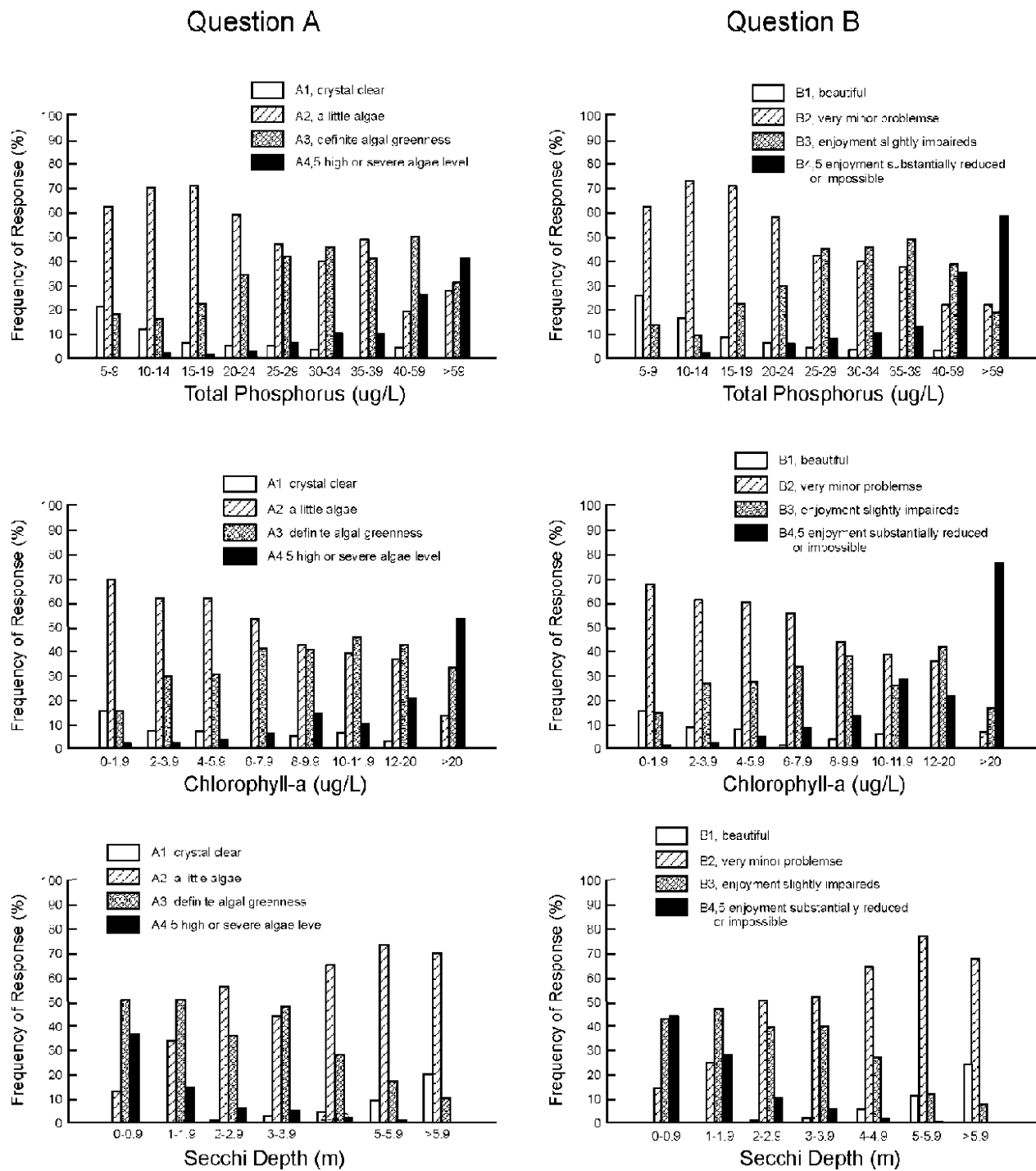

Smeltzr1

Figure 1. Lake Champlain user survey results, 1987-1991

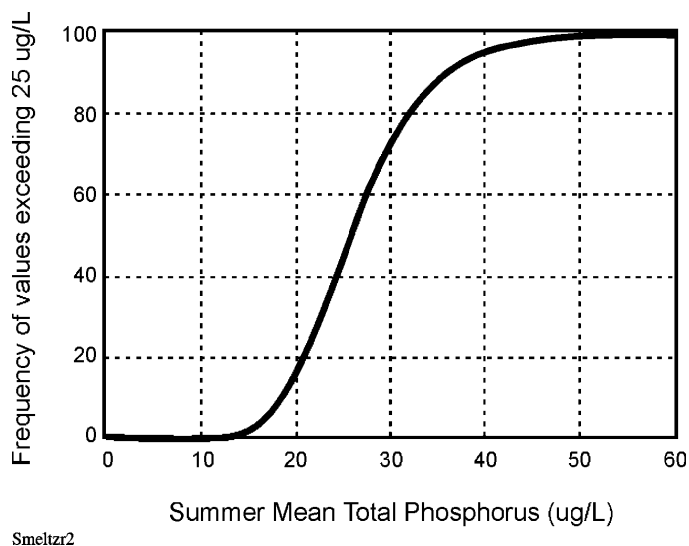

**Figure 2. Relationship between the summer mean total phosphorus concentration and the frequency of occurrence of instantaneous nuisance values (greater than 25  $\mu\text{g/L}$ ) at Lake Champlain water quality monitoring stations.**

A mean total phosphorus criterion of 14  $\mu\text{g/L}$  was established for seven segments of Lake Champlain, as shown in Table 2. In other lake segments, higher or lower criteria values were established based on limitations of practical attainability, or to provide antidegradation protection where existing phosphorus levels are below 14  $\mu\text{g/L}$ . The Lake Champlain phosphorus criteria listed in Table 2 were adopted by rule as part of the Vermont Water Quality Standards in 1991, and were later endorsed as joint management goals for Lake Champlain in a water quality agreement signed by New York, Quebec, and Vermont (Lake Champlain Phosphorus Management Task Force, 1992).

The user survey analysis provided a reasonably objective and empirically based method for deriving phosphorus criteria to protect recreational use and enjoyment of Lake Champlain. However, several limitations of the approach should be noted. The user survey was not based on a randomly chosen sample of public opinion, and should not be used to assess the general impressions of Lake Champlain water quality by the entire user public. Other potential eutrophication impacts such as shoreline periphyton and aquatic plant growth, hypolimnetic dissolved oxygen depletion, fisheries impacts, and water supply impairment were not considered in deriving the phosphorus criteria for Lake Champlain. The approach assumed that the instantaneous phosphorus value was an appropriate surrogate variable for the more direct causes of eutrophication nuisances such as high algal densities. Finally, a comparison of user survey results in Vermont and Minnesota revealed striking regional differences in user perceptions of lake water quality (Smeltzer and Heiskary, 1990). If a user survey approach is to serve as a basis for developing lake water quality criteria, then the data should be as specific to the lake region of concern as possible.

**Table 2. Total phosphorus criteria for Lake Champlain segments, compared with currently existing mean values. The criteria are applied as summer or annual mean values in central, open-water regions of each lake segment (Vermont Water Resources Board, 1996; Lake Champlain Phosphorus Management Task Force, 1993). Current levels are from Smeltzer and Quinn (1996).**

Lake Segment	Criterion Value ( $\mu\text{g/L}$ )	Current Level ( $\mu\text{g/L}$ )
Main Lake	10	12
Malletts Bay	10	9
Shelburne Bay	14	15
Burlington Bay	14	13
Cumberland Bay	14	14
Northeast Arm	14	14
Isle La Motte	14	12
Otter Creek	14	15
Port Henry	14	15
St. Albans Bay	17	24
Missisquoi Bay	25	35
South Lake A	25	34
South Lake B	25	58

### Application of the Criteria

A phosphorus budget and mass balance modeling analysis for Lake Champlain (Vermont DEC and New York State DEC, 1997; Smeltzer and Quinn, 1996) was used to determine the allowable phosphorus loadings from point and nonpoint sources in each state and each lake segment watershed. Optimization techniques were applied to the phosphorus mass balance model to find the minimum-cost set of watershed target loads that would attain the in-lake criteria listed in Table 2. Specific watershed phosphorus loading targets were then negotiated between the States of Vermont and New York and the U.S. Environmental Protection Agency. The loading targets and a 20-year implementation timetable were incorporated into a comprehensive plan for the Lake Champlain Basin prepared by the Lake Champlain Management Conference (1996).

The phosphorus criteria developed for Lake Champlain were essential to the phosphorus management process for the lake. The criteria provided the basis for a negotiated political agreement on phosphorus reduction in Lake Champlain. The agreement was based on a quantitative modeling analysis and optimized implementation strategies. This analysis and agreement would not have been possible without the prior establishment of numeric, in-lake phosphorus concentration goals consistently between the three government jurisdictions.

## References

Heiskary, S.A. and W.W. Walker. 1988. Developing phosphorus criteria for Minnesota lakes. *Lake and Reserv. Manage.* 4:1-10.

Lake Champlain Management Conference. 1996. Opportunities for action. An evolving plan for the future of the Lake Champlain Basin. Pollution prevention, control, and restoration plan. Lake Champlain Basin Program. Grand Isle, VT. 92 pp.

Lake Champlain Phosphorus Management Task Force. May 14, 1993 report prepared for the Lake Champlain Steering Committee. New York State Department of Environmental Conservation, Adirondack Park Agency, Quebec Ministry of the Environment, and Vermont Agency of Natural Resources. 17 pp.

North American Lake Management Society. 1992. Developing eutrophication standards for lakes and reservoirs. Report prepared by the Lake Standards Subcommittee. Alachua, FL. 51 pp.

Picotte, A. 1997. 1996 Lake Champlain Lay Monitoring Report. Vermont Department of Environmental Conservation. Waterbury, VT. 85 pp

Smeltzer, E. and S.A. Heiskary. 1990. Analysis and applications of lake user survey data. *Lake and Reserv. Manage.* 6:109-118.

Smeltzer, E. and S. Quinn. 1996. A phosphorus budget, model, and load reduction strategy for Lake Champlain. *Lake and Reserv. Manage.* 12:381-393.

Vermont Department of Environmental Conservation and New York State Department of Environmental Conservation. 1997. A phosphorus budget, model, and load reduction strategy for Lake Champlain. Lake Champlain diagnostic-feasibility study final report. Waterbury, VT and Albany, NY. 129 pp.

Vermont Water Resources Board. 1996. Vermont Water Quality Standards. Montpelier, VT. 45 pp.

Walker, W.W. 1985. Statistical bases for mean chlorophyll a criteria. pp. 57-62 In *Lake and Reservoir Management: Practical Applications*. Proceedings of the Fourth Annual Conference and International Symposium. October 16-19, 1984. McAfee, NJ. North American Lake Management Society.